



HEXAGON
MANUFACTURING INTELLIGENCE











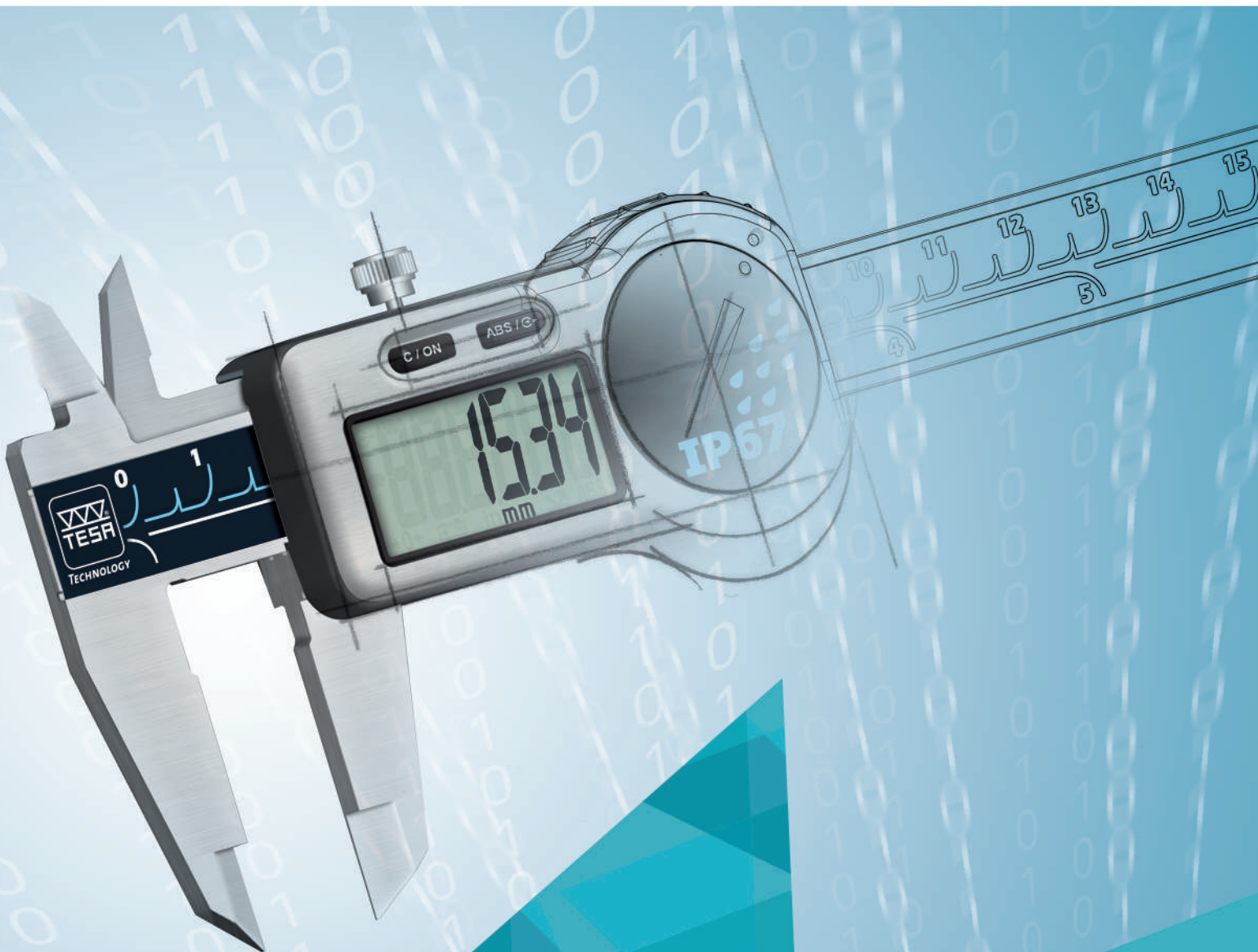









TESA
TECHNOLOGY

GENERAL CATALOGUE

Precision Measuring Instruments

Quality drives productivity



GENERAL INFORMATION		
CONNECTIVITY	A	
CALIPERS	B	
EXTERNAL MICROMETERS	C	
INTERNAL MEASUREMENT	D	
MEASURING INSTRUMENTS FOR LARGE DIMENSIONS	E	
DIAL GAUGES – ELECTRONIC AND ANALOGUE	F	
LEVER-TYPE DIAL TEST INDICATORS	G	
COMPARATIVE MEASUREMENT	H	
MEASURING SUPPORTS AND AUXILIARY EQUIPMENT	I	
STRAIGHTNESS, ANGLE AND INCLINATION MEASUREMENT	J	
LENGTH AND ANGLE STANDARDS	K	
CALIBRATION EQUIPMENT	L	
SURFACE ROUGHNESS TESTING	M	
HEIGHT GAUGES	N	
ELECTRONIC LENGTH MEASURING EQUIPMENT	O	
ACCESSORIES	P	

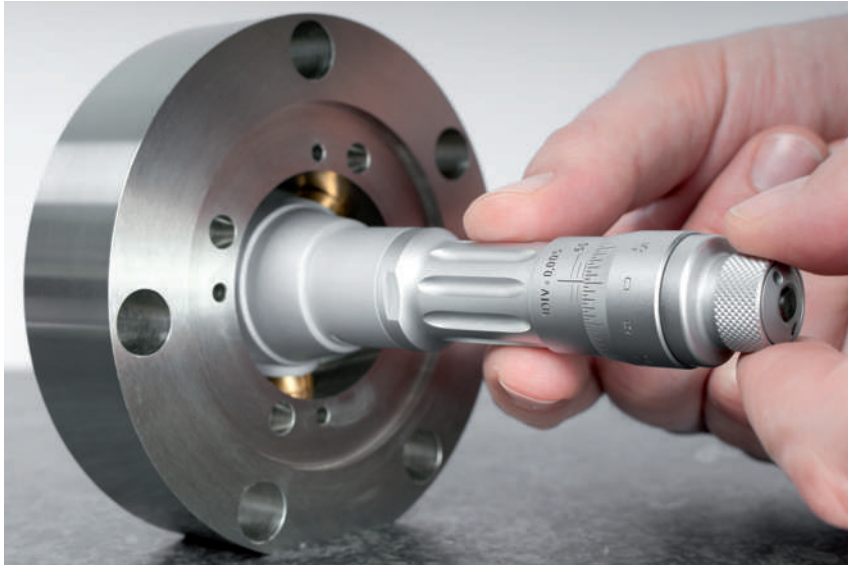

Bore measurement with a TESA IMICRO internal micrometer

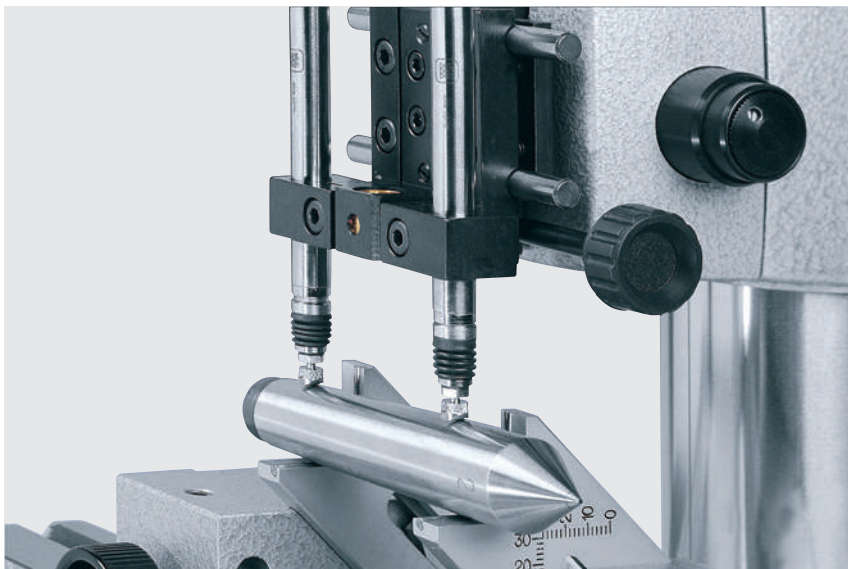

Measurement of difference between two inductive probes



Squareness verification with inductive probe and TWIN-T10 display



Dear Customers and Partners,

This catalogue reflects the image of TESA today. It is a company with solid roots in precision metrology that has been able to follow the trend of the times with cutting-edge technologies. Today, just as yesterday, TESA precision measuring instruments and solutions help customers to improve their quality control and increase their productivity.

Over the years, TESA has become the home for many renowned brands such as Brown&Sharpe, COMPAC, MERCER, ROCH, ETALON and INTERAPID. All these brands have added a great value and have shaped what TESA products today stand for: a unique blend of high excellence metrology tools with strong reputation for quality, reliability and durability.

TESA is today part of Hexagon Manufacturing Intelligence. As a leading, metrology and manufacturing solution specialist, the company's mission is to give customers the confidence to increase production speed and accelerate productivity while enhancing product quality. All the products in the Hexagon Manufacturing Intelligence portfolio support this objective in three areas – sensing, thinking and acting. Sensing: generating large quantities of accurate measurement data. Thinking: transforming that data into actionable information. Acting: applying corrections to the manufacturing process based on this information.

Going beyond the boundaries of traditional gauging tasks, TESA products smoothly integrate into the complete manufacturing solutions offered by Hexagon through advanced connectivity systems and software interfaces. They enable better use of data through integration with analytic systems like statistical process control (SPC) software and can help businesses to embrace Industry 4.0 principles.

We hope that this catalogue will inspire you to find new and better solutions to your measurement challenges.

*Stefan Ruh
TESA Managing Director
Hexagon Manufacturing Intelligence*



TESA – 75 YEARS OF TECHNOLOGY



1941

2016

Since its foundation 75 years ago, TESA has distinguished itself in the market through its unique expertise in micromechanics, precision machining and dimensional metrology.

With its roots and headquarters in Renens, Switzerland, a region well known for watchmaking, precision engineering and research, TESA has always been dedicated to precision, quality and the sustainability of its products.

Today as part of Hexagon Manufacturing Intelligence, TESA is a modern firm with an international footprint operating globally. Our measuring instruments help customers around the world find solutions for their metrology challenges, improving their quality control and increasing their productivity.

www.tesatechnology.com

www.HexagonMI.com



PASSION FOR PRECISION

Renowned TESA flagship products, like CCMA dial callipers, the UNIMASTER large dimension gauge, TESATAST level indicators, the IMICRO internal micrometer and our 1D probes – just to name a few – have been a standard in workshops for many decades.

With the evolution of digital communication, TESA made the next step and introduced TESA Link Connector (TLC) and wireless module. This allows today's TWIN-CAL calliper to be equipped with a unique TLC, as easily as replacing the battery cap of the device, enabling bidirectional communication between the instrument and the computer. Data can be sent directly to software, turning single data-points into actionable information.

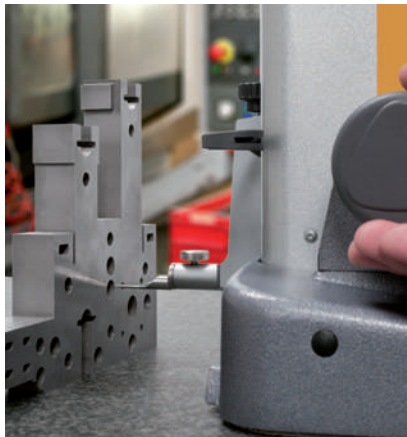
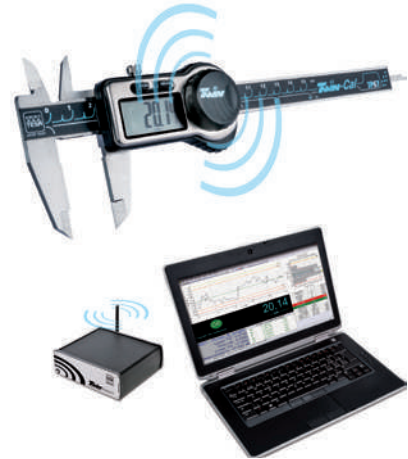

TESA Height Gauges are world market leaders in their class. With their versatility and accuracy, they are in many cases an easy to use and cost-efficient alternative to coordinate measurement machines (CMMs).

TESA is also a manufacturer of tactile and non-contact probing solutions for CMMs. Available through the worldwide sales network of Hexagon Manufacturing Intelligence, these products represent the high end of technical capabilities in sensing.

To maintain the value of our customers' investments, TESA pays exacting attention to customer support services. Our offering includes the core services of calibration, maintenance and repair. An SCS certified calibration lab, qualified for measurement uncertainties down to 0,02 μm , provides certification for measurement tools where accuracy and reliability matters.

Understanding that precision is not only a result of the right tool but also of environmental influences, we offer technical assistance for applications, product selection and installation as well as training from basic metrology up to specialist measurement tasks.

Our product customisation offering will help you to find solutions that go beyond the capabilities of standard tools.

Customer Service and Technical Support organisation TESA

Email us at tesa.service@hexagon.com

Call us on +41 21 611 18 40 – from 7.30 to 17.30 (CET)



QUANTITIES AND UNITS

International System of Units (SI)

F: Système international d'unités (SI)

D: Internationales Einheitensystem (SI)

Derived units (of measurement)

F: Unités dérivées

D: Abgeleitete Einheiten

Quantity	SI base unit	
	Name	Symbol
length	metre	m
mass	kilogram	kg
time	second	s
electric current	ampere	A
thermodynamic temperature	kelvin	K
amount of substance	mole	mol
luminous intensity	candela	cd

Quantity	Unit		Relationship to SI base unit
	Name	Symbol	
plane angle	radian	rad	1 rad = 1 m
			1 rad = 57,295 779 51°
frequency	hertz	Hz	1 Hz = 1 s ⁻¹
force	newton	N	1 N = 1 m kg s ⁻²
pressure	pascal	Pa	1 Pa = 1 m ⁻¹ kg s ⁻²
power	watt	W	1 W = 1 m ² kg s ⁻³
electrical potential	volt	V	1 V = 1 m ² kg s ⁻³ A ⁻¹

Decimal multiples and submultiples of the base unit "metre"

Unit	Symbol	m	cm	mm	µm	nm
kilometre	km	1 ³ m	1000 m	1 000 000 mm		
Metre	m	1 m	1 m	100 cm	1 000 mm	1 000 000 µm
decimetre	dm	10 ⁻¹ m	0,1 m	10 cm	100 mm	100 000 µm
centimetre	cm	10 ⁻² m	0,01 m	1 cm	10 mm	10 000 µm
Millimetre	mm	10⁻³ m	0,001 m	0,1 cm	1 mm	1 000 µm
tenth millimetre		10 ⁻⁴ m	0,000 1 m		0,1 mm	100 µm
hundredth millimetre		10 ⁻⁵ m	0,000 01 m		0,01 mm	10 µm
Micrometre	µm	10⁻⁶ m	0,000 001 m		0,001 mm	1 µm
tenth micrometre		10 ⁻⁷ m	0,000 000 1 m		0,000 1 mm	0,1 µm
hundredth micrometre		10 ⁻⁸ m	0,000 000 01 m		0,000 01 mm	0,01 µm
Nanometre	nm	10⁻⁹ m	0,000 000 001 m		0,000 001 mm	0,001 µm

Definition of the metre

F: Définition du mètre – D: Meterdefinition

"The metre is defined as the distance travelled by light in vacuum during a time of 1/299 792 458 of a second."

17th General Conference on Weights and Measures, 1983.

Reference temperature

F: Température de référence

D: Bezugstemperatur

For measuring instruments and workpieces, ISO R1 assesses this temperature is 20°C. The temperature of 20°C is assumed to be valid for any size, material measure, measurement result etc., unless otherwise specified.

MEASUREMENT TASKS

Inspecting

F: Contrôler – D: Prüfen

Determining whether a test object complies with specified requirements (e.g. as regards both dimensions and form).

Measuring

F: Mesurer – D: Messen

Obtaining a value (e.g. length value) measured by comparison against a master standard (e.g. material measure).

Calibrating

F: Etalonner – D: Kalibrieren

Establishing the actual deviation of a measuring instrument from desired value.

This is usually done through measurement operations. The result of a calibration is documented in the form of a calibration certificate and can be used later on for adjustment purposes, for instance.

INDICATION RELATED DEFINITIONS

Indication

F: Indication – D: Anzeige

The indication, which provides the information about the measured value, is directly perceptible by human senses. It may be optical, acoustic or based on any other output feature.

Displaying devices may either have a digital, analogue or any other special indication.

For material measures, the indication matches displayed value.

Note: According to the standards, the terms "analogue" and "digital" are only used to differentiate the methods of measurement. Therefore, they should not be used for the definition of the indications.

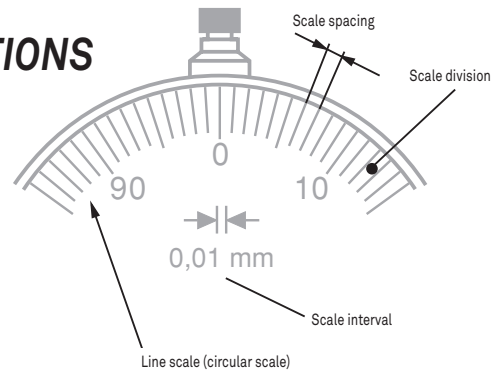

Scale indication

F: Indication de l'échelle – D: Skalenanzeige

Scale indication is the readable position of a scale mark.

Line scale

F: Echelle à traits – D: Strichskale

A line scale is the successive number of graduation (scale marks) on a scale.

Scale spacing

F: Longueur d'une division (d'échelle)

D: Teilstrichabstand

Scale spacing is expressed in length units as the distance between two successive scale marks measured along the same line by a marker (e.g. the end of a pointer).

Line scales

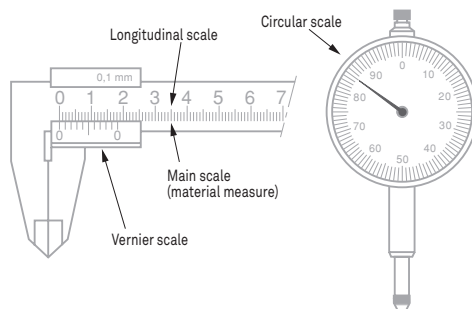

Scale division

F: Division d'échelle (échelon) – D: Skalenteil

Part of a scale between two successive scale marks.

Scale interval

F: Echelon, valeur d'une division (d'échelle)

D: Skalenteilungswert

The scale interval is the difference between the values matching two successive scale marks. This characteristic is expressed in the units marked on the scale.

Vernier interval

F: Valeur du vernier – D: Noniuswert

The vernier interval is the alteration of the value of a measurand, which in turn changes the indication by one scale division of the vernier scale.

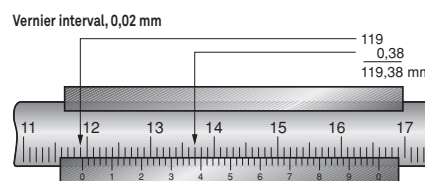
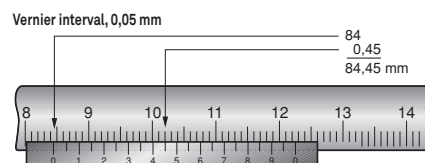

Numerical (digital) indication

F: Indication numérique

D: Ziffernanzeige

The numerical indication is shown in the form of a digit (succession of digits).

Numerical scale

F: Echelle numérique – D: Ziffernskale

A numerical scale is a succession of digits (usually 0 to 9). On a multi-scale, the single numerical scales are arranged side by side in a decimal fraction.

Numerical division

F: Pas (échelon) numérique – D: Ziffernschritt

The numerical division is the difference between two successive digits from their last position on a numerical scale.

Numerical interval

F: Valeur du pas (échelon) numérique

D: Ziffernschrittswert

The numerical interval is the alteration by one numerical value of the indication. This characteristic, which matches the scale interval, is expressed in the units of the measurand.

METROLOGICAL DEFINITIONS



Range of indication

F: Etendue d'indication – D: Anzeigebereich
The range of indication lies between the highest and lowest display values of a measuring instrument.



Measuring range

F: Etendue de mesure – D: Messbereich
The measuring range of an indicating device is the range within which the measured values cannot exceed the maximum permissible errors. For tools having several measuring ranges, these errors may vary from a range to another. The measuring range may well be contained within the related whole range of indication.



Measuring span

F: Champ de mesure – D: Messspanne
This span equals the difference between both first and last values of the measuring range as specified.



Displacement range

F: Etendue de déplacement – D: Verstellbereich
Measurand related extent within which the measuring range can be moved.



Application range

F: Etendue d'application
 D: Anwendungsbereich
The application range is equal to the sum of both displacement and measuring ranges.

Note: The first and last values make each range different from one another.

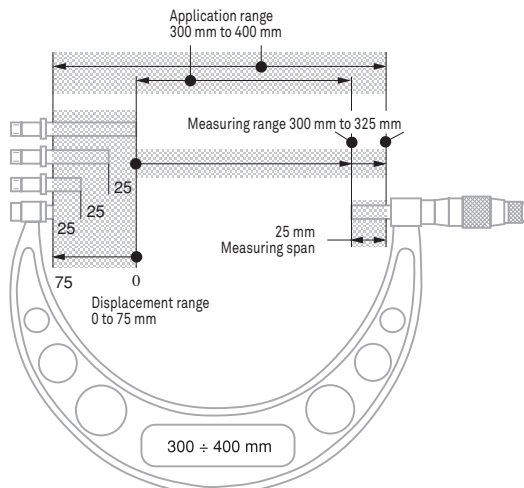

Measurand

F: Mesurande – D: Messgröße
Physical quantity of a measurement. In other words, the measurand is the length or the angle as measured or to be measured.

Measured value

F: Valeur mesurée – D: Messwert
Any measured value expresses the result of a measurement. Therefore, this value is directly associated with the measurand and further allocated to the output feature (e.g. display) of a measuring instrument or device. A measured value is expressed as the product of both numerical value and unit. The measured value includes the true value plus the random and systematic errors of the relevant tool.

Result of measurement

F: Résultat de mesure – D: Messergebnis
Product of a measured value once corrected on the basis of the known systematic errors. This result is further increased by the uncertainty of measurement, which includes the random as well as any unknown systematic error.

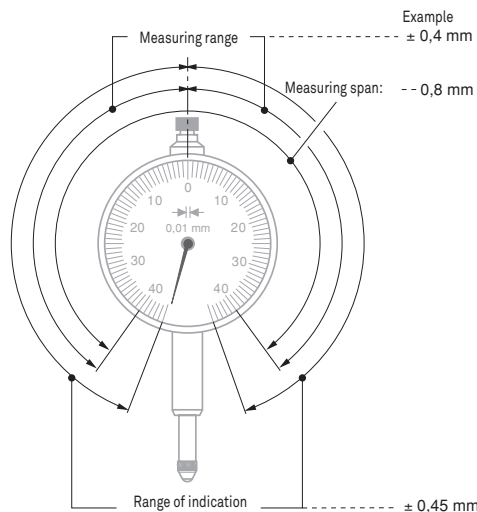
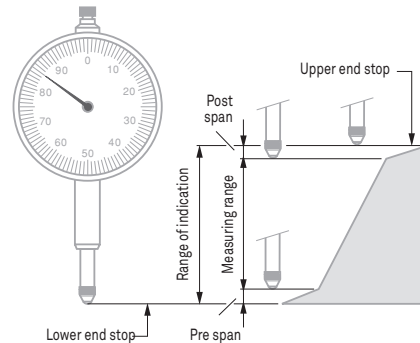
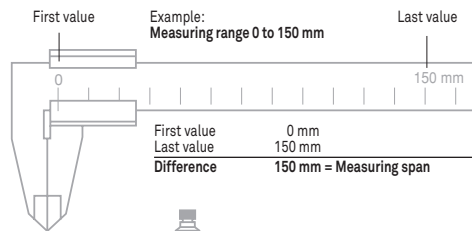

Permissible limits of a metrological characteristic MPL

F: Limites tolérées d'une caractéristique métrologique MPL

D: Grenzwerte eines Messtechnischen Merkmals MPL

Extreme permissible values of a metrological characteristic of a given measuring equipment, according to specifications or standards of the manufacturer or others.

Maximum permissible errors for a metrological characteristic MPE

F: Erreurs maximales tolérées d'une caractéristique métrologique MPE

D: Grenzwerte für Messabweichungen für ein messtechnisches Merkmal MPE

Extreme values of the permissible error for a metrological characteristic of a given measuring equipment, according to specifications or standards of the manufacturer or others.

Repeatability

F: Fidélité (répétabilité)

D: Wiederholpräzision

Ability of a measuring instrument to repeat the results obtained from the same measurand successively measured in the same direction, also under the same conditions.

Repeatability, which delivers important information for the assessment of the uncertainty of measurement, is quantitatively expressed as standard deviation of dispersion values.

Repeatability limit

F: Fidélité (répétabilité) limite

D: Wiederholgrenze

Extreme value for repeatability.

Maximum permissible errors G

F: Erreurs maximales tolérées G

D: Fehlergrenzen G

These errors are assimilated to the "Permissible limits of a metrological characteristic MPL".

Being related to both upper and lower highest deviations of a measuring instrument, they are usually symmetrical in practical metrology and, therefore, stated as single value, without any sign.

Deviation span of indication

F: Champ d'erreur d'indication

D: Abweichungsspanne

This deviation span matches the distance from the highest to the lowest point of a coordinate as shown on the relevant diagram. The value obtained is either applicable to whole or the local measuring span or measuring range.

All required measurements are carried out in one direction (without reversal of the measuring force) – i.e. with upward plunger movement for a dial gauge. For those needed to establish the whole deviation span, they are performed in both directions (with reversal of the measuring force) – i.e. with upward and downward movement of the plunger for a dial gauge.

Hysteresis

F: Hystérésis

D: (Messwert-) Umkehrspanne

Hysteresis expresses the difference between various indications of a measuring instrument. This value is achieved through measurements of the increasing/decreasing value of the same measurand, taken under the same conditions. Hysteresis, which is quantitatively stated as standard deviation of value dispersion, can be determined anywhere within the measuring span or range. Its amount can also be obtained from the diagram of the deviation span as a whole.

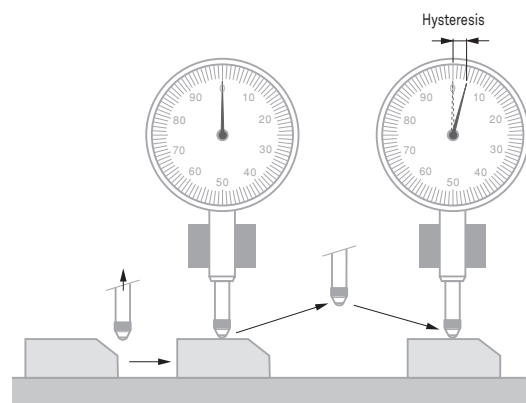
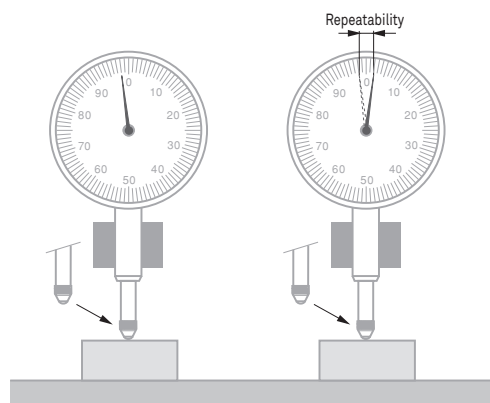

DECISION RULES FOR PROVING CONFORMITY OR NONCONFORMITY WITH SPECIFICATIONS

Relationship with the uncertainty of measurement

ISO 14253-1, which is a part of "Geometrical Product Specification GPS", provides "Rules for establishing the conformity or nonconformity with specifications". These rules are valid for "Inspection by measurements of workpieces and measuring equipment".

This ISO standard makes allowances for the uncertainty of measurement – or more precisely for the true uncertainty of any measurement whenever the conformity or nonconformity with a given specification must be proved. So, for a workpiece, the specification matches a preset tolerance while being equal to the maximum permissible errors for a metrological characteristic (MPE) for a measuring instrument.

Any given specification is a constant, whereas the measurement uncertainty is a variable which is affected by many components. Therefore, the zone of conformity or nonconformity depends on the size of the effective expanded uncertainty U .

Rule for proving conformity

Conformity is proved when the measurement result y is lying within the specification zone, reduced on either side by the expanded uncertainty U . Consequently, workpieces or measuring instruments can be accepted as far as their conformity with the specification is proved by the manufacturer (supplier).

Rule for proving nonconformity

Nonconformity is proved when the measurement result y is lying beyond the specification zone, increased on either side by the expanded uncertainty U . In such a case, the relevant measuring instruments can be rejected if the purchaser (customer) gives evidence of its non-conformance.

Neither conformity nor nonconformity can be proven

This often happens when the measurement result y associated with the expanded uncertainty U includes either of the LSL or USL specification limits. As a result, workpieces or measuring instruments can neither be automatically accepted nor rejected.

For such "dead end cases", it is advisable to follow the rule below.

- Repeat all measurements based on a reduced uncertainty, so that conformity or nonconformity can clearly be demonstrated. Usually, proceeding in this way benefits to the party that's able to provide the needed proof.

- Come to a mutual agreement providing the procedure to be applied if such cases arise.

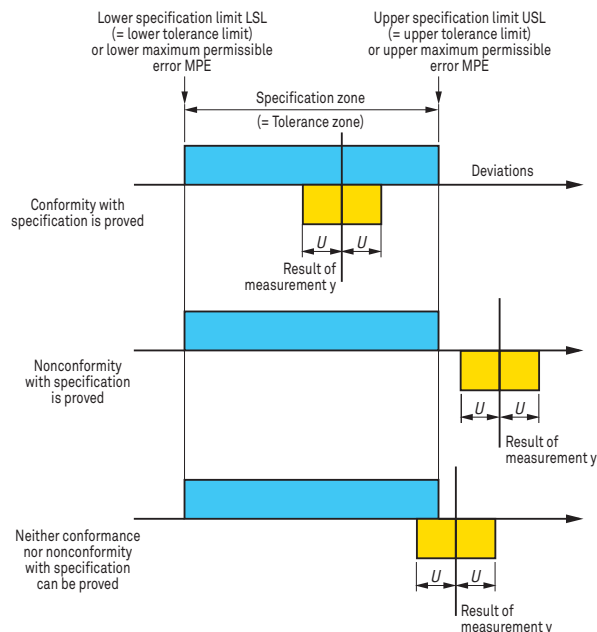
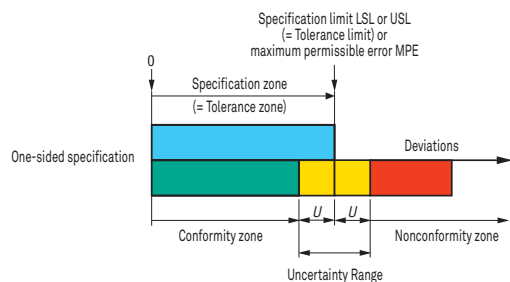
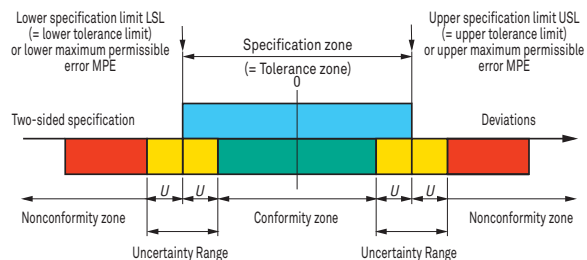

TRACEABILITY TO NATIONAL STANDARDS

All measuring equipment consistently used on our production site is traceable to national standards or reference fixtures through our quality management system.

Traceability is established by recalibration at regular intervals with documentary evidence as specified in the standards.

The illustration that follows shows the hierarchy of calibrations within the chain of traceability. The example set for the transfer of accuracy to our MICRO-HITE height gauges also shows how they are calibrated. Each feature is supplied with a free SCS calibration certificate issued by our laboratory, which is officially accredited by the Swiss Calibration Service.

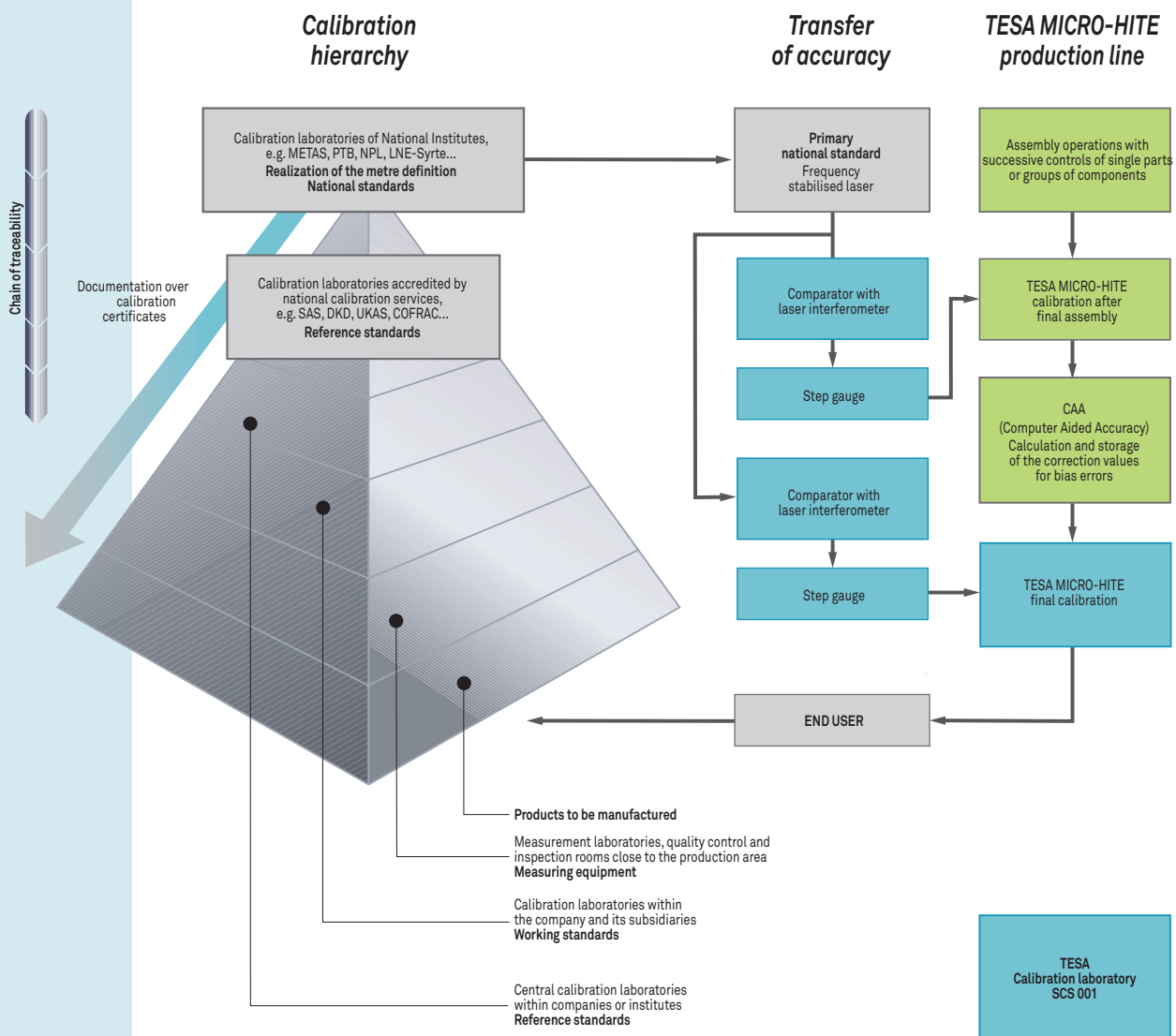



TECHNOLOGY



Connectivity

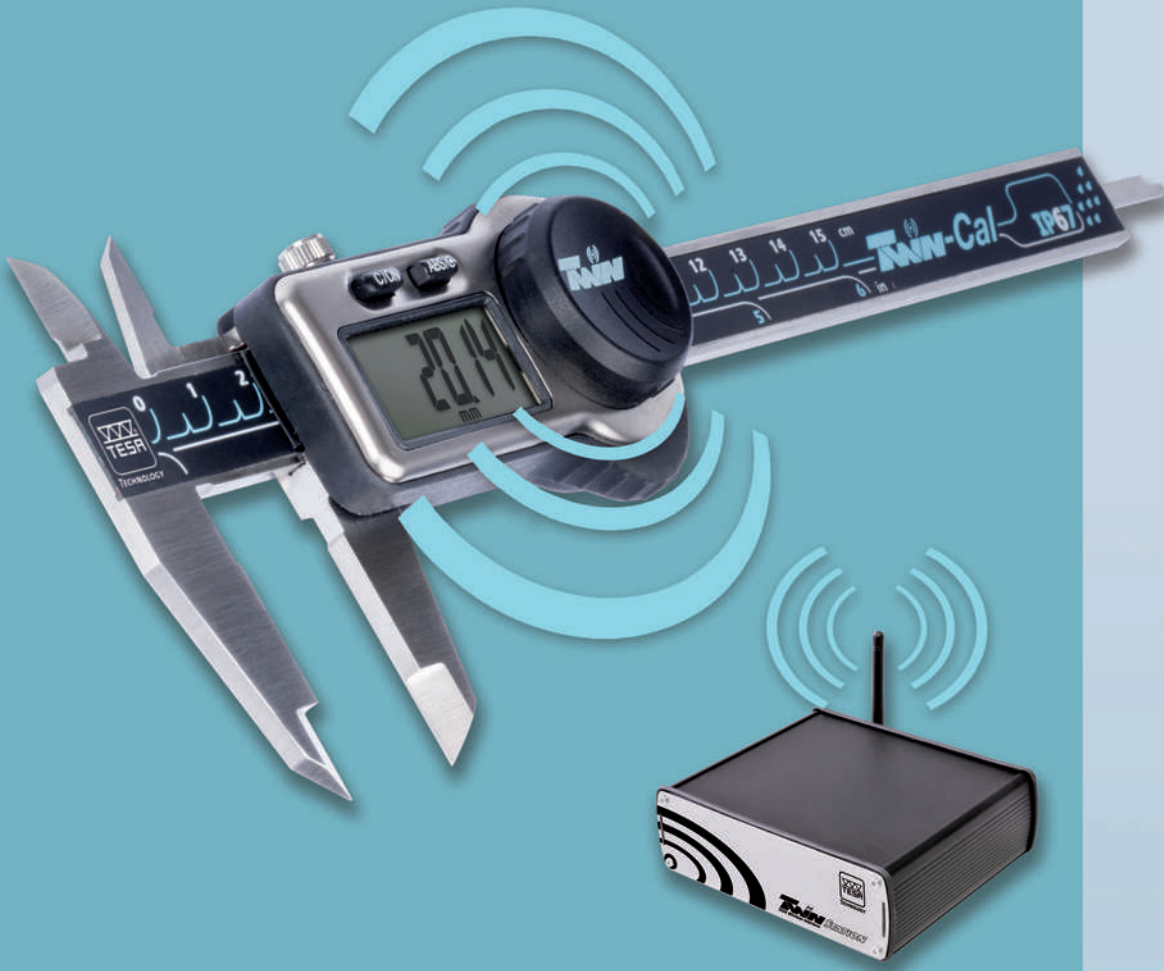

TESA SOFTWARE, CABLES AND LINKS FOR THE TRANSFER OF MEASURING RESULTS.

Inspection, traceability and cost reduction have a growing significance in all industrial sectors. This requires not only high quality metrology instruments, but also software suitable for evaluation and further analysis of the measurements carried out.

PRODUCTION		INSPECTION		EVALUATION	ARCHIVING	
						TESA DATA-DIRECT List of measurements, archiving, customised results calculations, traceability, statistics.
	↔		↔			TESA STAT-EXPRESS Statistical analysis of measurements, control charts, traceability and sharing of results.
						TESA PRINTER SPC Simple statistics, without the need for a PC, documented traceability.
		Measuring instrument		Software or portable printer	Database Electronic file (PDF) Printed report	

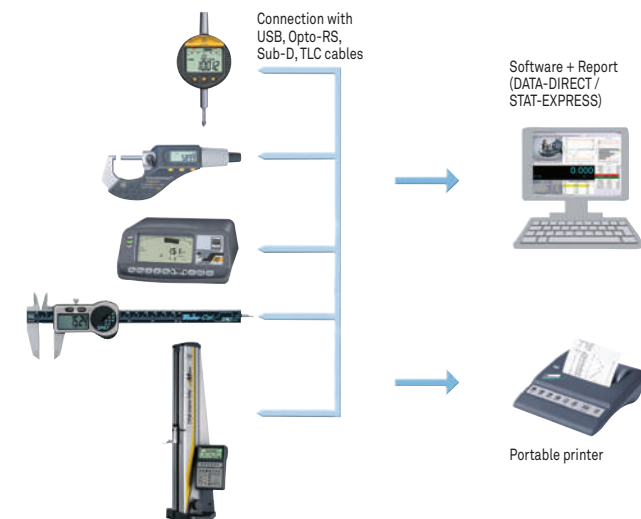

TESA offers various types of connection between measuring instruments and a PC as well as software for the management of results so that the production process can be optimised, quality improved and documents for traceability can be created.

DATA-DIRECT Software

DATA-DIRECT software is an easy way to collect and report results in real time from the majority of the measuring instruments in the TESA range that have a data output.

DATA-DIRECT is supplied not only with serial input/output drivers specially configured for TESA's products, but also for those purchased from other manufacturers. It works effectively to give data transfer for your data sheets, database, statistical modules or any other Windows-based applications.

With this user-friendly software you will be able to create your own reports for component inspection.

Minimum system requirements to run DATA-DIRECT:

- Pentium 4 or equivalent
- 512 MB RAM (live memory)
- 10 GB HD
- Windows XP, Windows 7 (32 or 64 bits) or Windows 8 (32 or 64 bits)

Please contact your TESA representative or an authorised distributor for a 30-day demo version.

Date:	Lot No.:	Operator:	Customer:	TESA TECHNOLOGY
12.03.2009	13.10.4678	XXX	TESA	TECHNOLOGY
Instrument	Measure	Date	Time	
OPTO-USB - cal IP 67	1.640	21.01.2010	12:06:06	
USB Probe GT25	-1.033	21.01.2010	12:06:06	
OPTO-USB - cal IP 67	1.640	21.01.2010	12:06:07	
USB Probe GT25	-1.033	21.01.2010	12:06:07	
OPTO-USB - cal IP 67	1.640	21.01.2010	12:06:07	
USB Probe GT25	-1.033	21.01.2010	12:06:08	
OPTO-USB - cal IP 67	1.640	21.01.2010	12:06:09	
USB Probe GT25	-1.033	21.01.2010	12:06:09	
OPTO-USB - cal IP 67	1.640	21.01.2010	12:06:10	
USB Probe GT25	-1.033	21.01.2010	12:06:10	
OPTO-USB - cal IP 67	1.640	21.01.2010	12:06:12	
USB Probe GT25	-1.033	21.01.2010	12:06:12	
OPTO-USB - cal IP 67	1.640	21.01.2010	12:06:13	
USB Probe GT25	-1.033	21.01.2010	12:06:13	
OPTO-USB - cal IP 67	1.640	21.01.2010	12:06:15	
USB Probe GT25	-1.033	21.01.2010	12:06:15	

List of measured values within a third party software, e.g. MS Excel

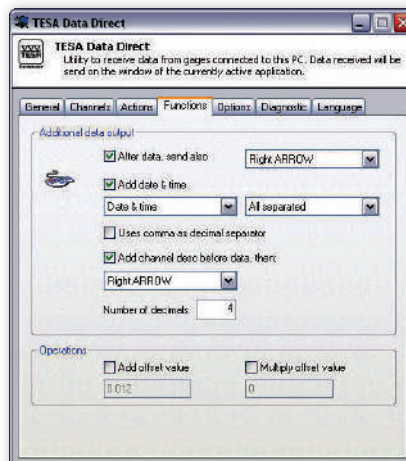

Tab function providing the facility to present the measured values

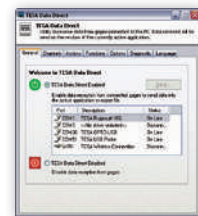

DATA-DIRECT: main window



Real time display of the measured value in a separate window



Customisable tool bar

04981001	DATA-DIRECT Software and dongle	Included in delivery
		TESA DATA-DIRECT installation CD with licence key (dongle) USB and user instructions (PDF version)

TESA DATA-DIRECT Software	
TESA Instruments compatible with DATA-DIRECT	Opto-RS Cables – Opto-USB Cables – Height gauges (TESA-HITE, MICRO-HITE) – USB probes – Surface roughness gauges RUGOSURF 10 / 20 / 10G / 90G – TPS presetting bench – BPX probe interface – TWIN-STATION wireless probe interface – TESA wireless systems – TLC-TWIN wireless transceiver
Other instruments compatible with DATA-DIRECT	Custom made instruments with RS232 output – Instruments from other makers: Mitutoyo: DMX3 - DMX8 – Steinwald single 6 – Etc.
Functions	Export of results to .csv file – ASCII commands – Real time display of measured results on a PC (except for models using the Rf-USB receiver)



STAT-EXPRESS Software

STAT-EXPRESS is a dedicated software package that enables the application of quality assurance into your manufacturing processes. It allows the downloading, reporting, transfer and storage of your quality-oriented control charts.

STAT-EXPRESS is compatible with all TESA's products – from calipers through to CMM or Vision machines. As an integrated software tool, STAT-EXPRESS provides the flexibility required for easy data transfer from most of the electronic gauges currently available on the market.

STAT-EXPRESS offers the ability to create reports including measured values obtained from a single instrument or several handtools, assign tolerances, calculate statistics, print out various measurement reports, compute XR control charts, and much more.



Measuring display with the option of adding operational instructions, accompanied with a photo or drawing

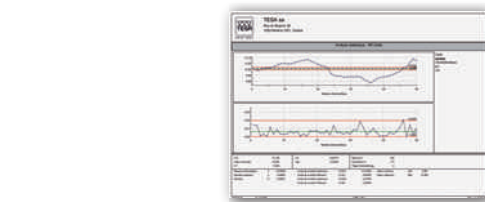

Simultaneous data acquisition from several measurement programmes

Minimum system requirements to run STAT-EXPRESS:

- Pentium 4 or equivalent
- 512 MB RAM (live memory)
- 10 GB HD
- Windows XP, Windows 7 (32 or 64 bits) or Windows 8 (32 or 64 bits)

Please contact your TESA representative or an authorised distributor for a 30-day demo version.



Detailed measuring report for each feature measured



Detailed measuring report for each part measured, together with serial number

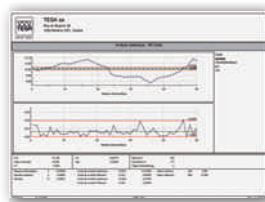

XR Control chart

<p>04981002</p>	<p>STAT-EXPRESS software and dongle</p>	<p>Included in delivery TESA DATA-DIRECT installation CD with USB licence key (dongle) and user instructions (PDF version)</p>
-----------------	---	--

STAT-EXPRESS Software	
TESA instruments compatible with STAT-EXPRESS	Opto-RS cables – Opto-USB cables – Height gauges (TESA-HITE, MICRO-HITE) – USB probes – Surface roughness gauges: RUGOSURF 10 / 20 / 10G / 90G – TPS presetting bench – BPI Probe interface – BPX probe interface – TWIN-STATION wireless probe interface – TESA wireless systems – TLC-TWIN wireless emitter-receiver
Other instruments compatibles with STAT-EXPRESS	Custom made instruments with RS232 ouput – Instruments from other makers: Mitutoyo: DMX3 - DMX8 – Steinwald single 6 – etc.
Features	DATA-DIRECT included – Export of results to .csv file – Import of .csv files – Table of all measured results – XR control charts – Report by part measured – Report by feature measured – Simultaneous data acquisition – Overall report with statistics – Measuring report in .pdf or .html format etc.– Security protection set for each user

USB Accessories: Adaptor Sub-D 9p/m/USB, Multiplexer USB, Foot Switch USB







S47120002



S47120003



04761071

			
		L, m	Connector (to PC or system)
S47120002	USB-D-Sub 9p/m adapter cable	0,1	USB
S47120003	USB multiplexer with 7 USB 2.0 ports. with external power supply, Max 4x 04761062 and 04761063.		USB
04761071	USB footswitch. For simultaneous data request from DATA-DIRECT or STAT-EXPRESS software of all connected instruments	2	USB



TESA Portable SPC PRINTER

TESA portable intelligent printer designed for the inspection of finished parts or incoming goods – Provides SPC statistics and prints out measurement results with graphical representations.

The TESA SPC PRINTER can be connected not only to TESA measuring instruments, but also to those provided with a DIGIMATIC output – Your TESA SPC PRINTER is capable of recognising the plug in tool and will execute the appropriate configuration automatically.



TESA SPC Printer

- Memory capacity : 9999 single values for one feature per sample.
- Two operating modes: "Normal" and "Tolerance".
- Limits of size quickly set on the display of the connected instrument with subsequent transfer to TESA PRINTER SPC.
- Output of statistical values printed out with graphical representations.
- Output of reports with headings to be filled in by the operator.
- Hardcopies printed in preferred language (English, German, French, Italian or Spanish).
- Battery-powered (6 V) printer unit for use on the move (optional).

06430000	SPC PRINTER EU Portable. With memory, SPC, value classification and graphs. RS232 interface
<i>DELIVERED WITH THE FOLLOWING ACCESSORIES:</i>	
04765013	Roll of printer paper, width = 110 mm for TESA SPC Printer
04761054	Mains adapter /battery charger 100 ÷ 240 VAC 50 ÷ 60 Hz, 6,6 Vdc, 750 mAh supplied without cable
04761055	EU Mains cable for 04761054 adapter
<i>OPTIONAL ACCESSORIES:</i>	
04761056	USA Mains cable
04768035	Battery charger 6V, 0,5AH

- 180 x 180 x 84 mm (W x D x H)
- Paper width: 110 mm. Print mode: 40 signs/line
- RS232 for data inputs (9-pin male, trapezoid connector) DIGIMATIC (Ansley connector, 10-pin) Connector with mini-jack for remote triggering of data transfer
- Mains adapter 100 to 240 Vac, 6,6 Vdc. Optional accessory: 6 V rechargeable battery pack.
- IP40 (IEC 60529)
- EN 50081-1, EN 50081-2, EN 50082-1, EN 50082-2

	"Normal" Mode	"Tolerance" Mode
Lower size limit (min.)	–	●
Upper size limit (max.)	–	●
Tolerance	–	●
Number of values taken:		
number of samples	●	●
< smallest dimension	–	●
> largest dimension	–	●
% out of tolerance	–	●
Lowest value listed	●	●
Highest value listed	●	●
Dispersion R	●	●
Arithmetical mean	●	●
Standard deviation sn, sn-1	●	●
Indication of capacity Cp, Cpk	–	●
Graphical representations:		
Position of each single value within the tolerance zone (10 classes)	–	●
Graphical representations:		
Histogrammes	–	●
Display (LED) - Classification of the value measured: Green for pass, yellow for rework, red for reject	–	●

 1 x CR2032 3,0V,
230mAh

 12 months. Can
be influenced by
battery level.

 EN 61326-1
EN 61000-4-3
ROHS, according to
2002/95/CE
EMC, according to
2004/108/CE
DEEE, according to
2002/96CE
REACH 1907/2006
ETSI EN 300 440 – 2
(CH et EU)
CFR and FCC 15.249

Wireless Connection for TWIN-STATION Receiver

The ultimate in flexibility and freedom of movement.

TESA TLC-TWIN wireless technology offers the flexibility of a hand tool thanks to bidirectional communication made possible by an instrument equipped with a TLC (TESA Link Connector) also compatible with the:

- TLC-TWIN-emitter/receiver station
- TLC-USB connecting cable
- TLC-Digimatic connecting cable.





*** The sale of the TLC-TWIN is currently restricted to EU countries, Switzerland USA and Canada
*** Please contact TESA for further information.

Up to 48 instruments can be managed by the TWIN-STATION receiver over a maximum range of 12 m.

The IP67 degree of protection of an instrument is preserved, even when the TLC-TWIN is connected.

When a visual check that the measured result has been sent to the computer is not possible, an indication on the display of the instrument enables the user to confirm that the result has been sent and received.



No	=				
		Operating range, m	Compatible with connector	Diameter, mm	Weight, g
04760180	TESA TLC-TWIN wireless emitter-receiver. Compatible with any instrument fitted with a TLC (TESA Link Connector)	~ 12 (dependent on conditions)	TLC (TESA Link Connector)	Ø 28	~ 10
OPTIONAL ACCESSORIES:					
05030012	TWIN-STATION BPW Probe box				
04981001	DATA-DIRECT software and dongle				
04981002	STAT-EXPRESS software and dongle				



TWIN-STATION Receiver

TWIN-STATION: Receiver for wireless TLC-TWIN emitter-receiver units
 Receives input signals from wireless TLC-TWIN emitter-receiver units
 Output signals – digital, RS232

- Direct connection to a PC via the USB port.
- Optimal use for your measuring tasks as up to 48 instruments equipped with TLC-TWIN can be connected to this unit.
- Great reliability.

*** the sale of TWIN-STATION is currently limited to EU countries, Switzerland, USA and Canada
 *** Please contact TESA for further details.



TWIN-STATION (front view)

TWIN-STATION (rear view)

No	=	A	⚙️	📦
		Number of instruments with TLC-TWIN	Power supply	Weight, kg
05030012	TWIN-STATION for TLC-TWIN wireless data transmission	48	Power supply via: - USB port of the PC - connected USB hub - USB hub of the BPX interface	0,85

- Housing case in aluminium
- Power supply via the connection of the USB cable: - directly to the PC (USB Port) to a mains powered USB hub
- IP 40 (IEC 60529) (DIN 40050)
- IEC/EN 61326-1 U.S. 47 CFR part 15, subpart B, Class B digital device
- Data transfer delay from digital serial output (USB): depends on the operating system of the computer.
- RS232
- 55 x 172 x 155 mm (H x W x D)
- USB Cable 1,80 m
- For a temperature of 20° C and a relative humidity of ≤ 50%: Digital output: ± (0,05 + 0,15% of the measuring range)

Transfer of Results with TESA LINK CONNECTOR TLC

TESA presents its new connectivity concept: the TLC connector that allows freedom of movement, flexibility, and ease of use, all combined.

Once an instrument is equipped with a TLC connector:

- 1) There is no longer any need to choose between a model with or without data output.
- 2) There is inbuilt compatibility for both cable and wireless connectivity.
- 3) A TLC connector can also be used for connection to a USB interface, a DIGIMATIC interface or for wireless connection, using a suitable cable or emitter-receiver unit, see table below:

Instrument equipped with a TLC connector. For example, TESA TWIN-CAL IP67 caliper



Wireless connection	Cable connection	
TLC-TWIN Two way wireless emitter-receiver unit	TLC-USB Two way communication cable	TLC-DIGIMATIC Two way communication cable
+	+	+
TWIN-STATION receiver base station for signals from the wireless TLC emitter-receiver unit	Interface with USB port	DIGIMATIC* interface
Personal computer		

* Please check with TESA for the list of equipment and instruments compatible with TESA-DIGIMATIC

OPTO AND SUB-D CONNECTION

Standard Opto Connection

Any connecting cable is defined by each of the connectors fitted at either end of the cable principally to suit the computer, and the measuring instrument being used. To achieve highest compatibility levels, TESA uses only standardized and proven connectors.

Examples of instruments with type Opto connector:

TESA-CAL IP67 / IP65 – TESA MICROMASTER – TESA IMICRO –
TESA ALESOMETRE – TESA DIGICO 10 / 11 / 205 / 305 / 400 / 500 / 600 / 705 –
TESATRONIC TT20 / TT60 / TT80 / TT90 – INTERAPID - Light

No	=	L, m	Connection (to instrument)	Connection (to PC or system)
04761062	Opto-USB cable, duplex, bidirectional communication	2	Opto-RS232	Type A USB
04761046	Opto-RS cable, simplex, 2 m, one way communication: from the instrument to the PC	2	Opto-RS232	Sub-D 9p/f Simplex
S47010022	Opto-RS cable, simplex, 5 m, one way communication: from the instrument to the PC	5	Opto-RS232	Sub-D 9p/f Simplex
04761049	Opto-RS cable, duplex, 2 m, bidirectional communication	2	Opto-RS232	Sub-D 9p/f Duplex
S47010024	Opto-RS cable, duplex, 5 m, bidirectional communication	5	Opto-RS232	Sub-D 9p/f Duplex
04761027	Connecting cable without connector	2	Opto-RS232	Without connector



Current systems	Compatible connectors	
TESA PRINTER SPC	Sub-D 9p/f	Ansley 10p/f
Computer	USB	Sub-D 9p/f

Standard Sub-D Connection

RS232, Sub-D 9p/m connector connecting cables for the following machines or precision handtools:TESA MICRO-HITE /TESA-HITE / TESA-μHITE / TESA TG / 3D Machines



No	=	L, m	Connector (to instrument)	Connector (to PC or system)
04761063	Sub-D 9p/m to USB cable, 2M	2	Sub-D 9p/m	USB
04761052	Extension cable, Sub-D 9p/f to 9p/m, 2 m	2	Sub-D 9p/m	Sub-D 9p/f
S47010025	Extension cable, Sub-D 9p/f to 9p/m, 10 m	10	Sub-D 9p/m	Sub-D 9p/f
S47120002	Sub-D 9p/m to USB adapter cable	0,1	Sub-D 9p/m	USB



Connecting Cables from the Instrument to a PC or Computer Controlled System



04760181



04760182



Instrument connection: special CLINOBEVEL



04761038



Instrument connection: special DIGICO 12



PC/system connection: Ansley 10p/f



Instrument connection: MiniDIN 8p/m



Instrument connection: Special for DIGICO 1 or 2

No	=	L, m	Connection (to instrument)	Connection (to PC or system)
04760181	TESA TLC-USB CABLE for instruments with a TLC connector	2	TLC (TESA Link Connector)	USB
04760182	TLC-DIGIMATIC CABLE for instruments with a TLC connector	2	TLC (TESA Link Connector)	Ansley connector 10 pin/f
04761023	Cable: miniDIN 8p/m to Sub-D 9p/f, 2 m for TT10 and MICRO-HITE manual versions 10/11/12	2	MiniDIN 8p/m	Sub-D 9p/f
04761024	Cable: miniDIN 8p/m to Sub-D 25p/m, 2 m for TT10 and MICRO-HITE manual versions 10/11/12	2	MiniDIN 8p/m	Sub-D 25p/m
04761038	Cable: miniDIN 8p/m to Sub-D 25p/m for DIGICO 1 and 2, with powered display	3	Special connector for DIGICO 1 or 2	Sub-D 25p/f
S47078588	Cable for DIGICO 1 or 2 and TESA SPC printer	2	Special connector for DIGICO 1 or 2	Ansley connector 10 pin/f
04761060	RS232 cable with external power supply	2	Specially for DIGICO 12 and TESA IP65 electronic lever type dial test indicators	Sub-D 9p/f
03969007	RS232 Sub-D 9p/f to Sub-D 9p/f, 3 m cable for TESA-REFLEX MH3D, TESA-SCOPE	3	Specially for DIGICO 12 and TESA IP65 electronic lever type dial test indicators	Sub-D 9p/f
S53300165	USB Cable for CLINOBEVEL 1 L = 1,8 m	1,8	Special connector for CLINOBEVEL 1	USB
S53070174	USB Cable for CLINOBEVEL 2 L = 2,5 m	2,5	Special connector for CLINOBEVEL 2	Sub-D 9p/f

Hand / Foot Switches, Adapters, Battery Chargers, Power Cables



04768001



04768000





04761054



04761017



S47001891

				
		L, mm	Connection (to instrument)	Connection (to PC or system)
04768000	Hand switch for triggering data transfer. Jack plug, 1,8 m – to TESA SPC PRINTER – to TESATRONIC (TT) display units	1,8	–	Jack plug
04768001	Foot switch for triggering data transfer. Jack plug, 1,8 m – to TESA SPC PRINTER – to TESATRONIC (TT) display units	1,8	–	Jack plug
04761017	Adapter ADP-01 Sub-D 9p/f to Sub-D 25p/m		–	–
S47001891	DIGIMATIC adapter for 04761046 cable Sub-D 9p/m to Ansley 10p/f	0,2	–	Sub-D 9p/f or Ansley 10p/f
04761054	Mains adapter /battery charger 100 ÷ 240 VAC, 50 ÷ 60 Hz, 6,6 Vdc, 750 mAh, supplied without cable	2	DC-Jack	–
04761055	EU mains cable for 04761054	1,5	–	–
04761056	USA mains cable for 04761054	1,5	–	–
04761037	Mains cable 230V for DIGICO 1 or 2	2	Special connector for DIGICO 1 or 2	–
04761057	Mains cable 110V for DIGICO 1 or 2	2	Special connector for DIGICO 1 or 2	Sub-D 9p/f



Connecting Cables for RUGOSURF to PC or Printer

Connecting cables for RUGOSURF roughness gauges



04760099



06960062 version 3



058213



056109



04760099	Cable RUGOSURF 20 to PC
06960062	Cable RUGOSURF 10G and RUGOSURF 90G to PC (connector v3)
058213	Connecting cable RUGOSURF 20 to dot matrix printer
056109	Connecting cable RUGOSURF 10G and RUGOSURF 90G to dot matrix printer

Calipers

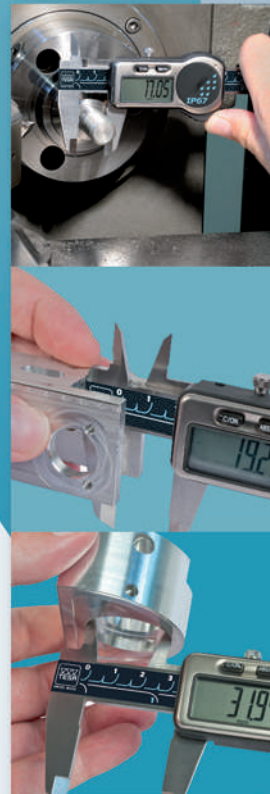

THE ESSENTIALS

Calipers are the most popular length measuring instruments used worldwide. Owing to their simple construction, ease of handling and quick operation, they are a favourite for dimensional measurement. The wide variety of models available with specialised measuring faces make them universal hand-held tools.

All TESA, ETALON, INTERAPID branded calipers are recognised for their superior quality – and guarantee you precise measurement. The flawless guide of the slider on the beam ensures silky-smooth operation whilst also preventing the measuring jaws from tilting.

The choice of material, subjected to precisely defined heat treatment as well as a robust design result in further distinctive advantages such as wear and corrosion resistance.

For quick and easy reading of measured values – one of the essential conditions for the assurance of your measurements – we offer conventional vernier models as well as dial models for easy reading and digital models for error-free reading.

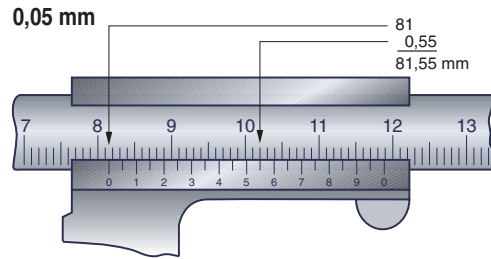
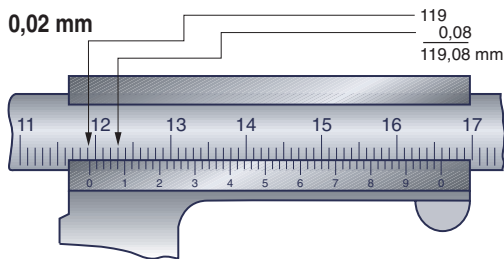

Chosen Length L mm	0,1 mm 0,05 mm μm	0,02 mm μm	0,01 mm μm
50	50	20	20
100	50	20	20
150	50	30	30
300	50	30	30
400	60	30	30
500	70	30	30
600	80	30	30
700	90	40	40
800	100	40	40
900	110	40	40
1000	120	40	40
1200	140	50	
1400	160	50	
1600	180	60	
1800	200	60	
2000	220	60	

The max. permissible errors (G) are expressed by the equation given below, where the values should be rounded down to two decimal fractions (0,01 mm). These errors apply for measurements taken under the same measuring force. For all other measurements, including those performed with use of the depth foot, the values obtained have to be increased by 20 μm.

Calipers with dial or vernier reading to 0,1 or 0,05 mm :
 $G = (20 + l / 10 \text{ mm}) \mu\text{m} \geq 50 \mu\text{m}$

Calipers with analogue indication (scale or vernier reading to 0,02 mm) or digital indication :
 $G = (22 + l / 50 \text{ mm}) \mu\text{m}$

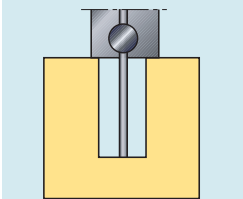
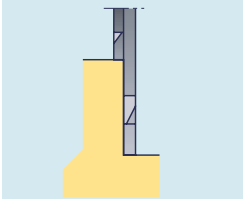
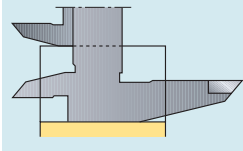
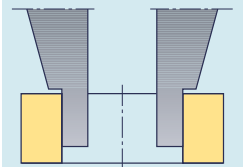
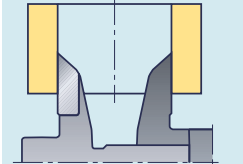
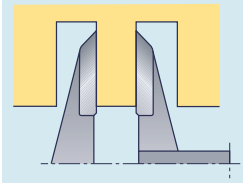
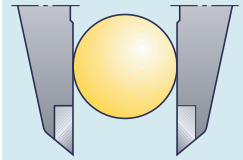

- ISO 13385-1
- 0,01 mm / 0.0005 in
- LCD, 11 mm
- Fixed zero
- mm / in conversion
- ≤ 100 mm: 20 µm
>100 mm: 30 µm
- 10 µm
- Scale with incremental divisions, inductive
- 2,5 m/s
- TLC Connectivity
- Stainless steel
- Lithium battery, 3V, CR2032
- 12.000 hours
- Standby mode after 10 minutes, instrument retains the zero position. Automatic shut off after 2 hours, instrument retains the zero in ABS mode, but the zero must be reset if the instrument is in DIFF mode.
- 1907/2006/CE
2004/108/CE
2002/96/CE
- Inspection report and declaration of conformity

TWIN-CAL IP67

Welcome to the new generation of TESA electronic calipers, with the highest degree of protection ever offered.

The TWIN-CAL IP67 are all equipped with TLC (TESA Link Connector), the unique integral data output facility, providing the opportunity to upgrade your caliper at any time.

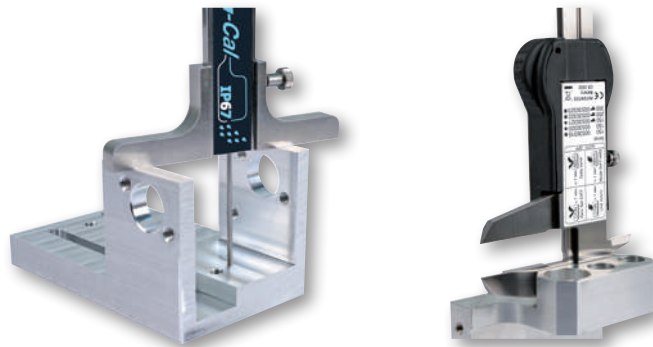
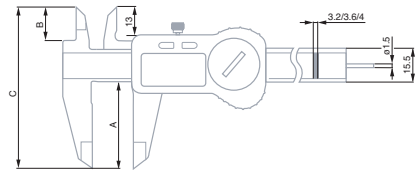

	mm	in	Drive system / Thumb Roller	A mm	B mm	C mm	g	Depth rod
00530319	150	6	–	40	16	74	150	Square
00530320	150	6	–	40	16	74	150	Round
00530321	150	6	With	40	16	74	150	Round
00530322	200	8	With	50	20	90	200	Square
00530323	300	12	With	64	22	106	280	Square

OPTIONAL ACCESSORIES:

00560013	Depth foot for calipers up to 150 mm
01961000	Lithium battery, 3V, CR2032
04760180	TESA TLC-TWIN wireless emitter-receiver Compatible with any instrument fitted with a TLC – TESA Link Connector
04760181	TESA TLC-USB cable for instruments with a TLC connector
04760182	TLC-DIGIMATIC cable for instruments with a TLC connector



TWIN-CAL IP40

The new TWIN-CAL calipers are all supplied with a built in data output port. Simply plug the TESA TLC connector into the TWIN-CAL and the other end into a PC and all your measurement results will be captured and stored for optimal SPC monitoring.



- ISO 13385-1
- 0,01 mm / 0.0005 in
- LCD, 11 mm
- Fixed zero
- mm/in conversion
- ≤ 100 mm: 20 µm
>100 mm: 30 µm
- 10 µm
- Scale with incremental divisions, inductive
- 2,5 m/s
- TLC connectivity
- Stainless steel
- 3V Lithium battery, CR2032
- 12.000 hours
- Standby mode after 10 minutes, instrument retains zero. Automatic shut off after 2 hours. The instrument retains zero in ABS mode, but if the instrument is in DIFF mode, the zero must be reset.
- 1907/2006/CE
2004/108/CE
2002/96/CE
- Inspection report with declaration of conformity

	mm	in	Drive system / Thumb roller	A mm	B mm	C mm	g	Depth rod
00530094	150	6	With	40	16	74	150	Round
00530097	150	6	-	40	16	74	150	Square
00530095	200	8	With	50	20	90	200	Square
00530096	300	12	With	64	22	106	280	Square

OPTIONAL ACCESSORIES:

00560013	Depth foot for calipers up to 150 mm
01961000	Lithium battery, 3V, CR2032
04760180	TESA TLC-TWIN wireless emitter-receiver Compatible with any instrument fitted with a TLC – TESA Link Connector
04760181	TESA TLC-USB cable for instruments with a TLC connector
04760182	TLC-DIGIMATIC cable for instruments with a TLC connector

- ISO 13385-1
- 0,01 mm / 0.0005 in
- LCD, 11 mm
- Fixed zero
- mm / in conversion
- ≤ 100 mm = 20 µm
>100 mm = 30 µm
- 10 µm
- Scale with incremental divisions, capacitive
- 2,5 m/s
- Stainless steel
- 3V Lithium battery, CR2032
- 1.5 to 2 years
- Standby mode after 10 minutes, instrument retains zero. Automatic shut off after 2 hours. The instrument retains zero in ABS mode, but if the instrument is in DIFF mode, the zero must be reset.
- 1907/2006/CE
2004/108/CE
2002/96/CE
- Inspection report with declaration of conformity

TESA VALUeline IP67

TESA Valueline is designed to meet customer demand for affordable products that don't compromise on the expertise associated with TESA. With TESA technology at their core, these products are of guaranteed quality.

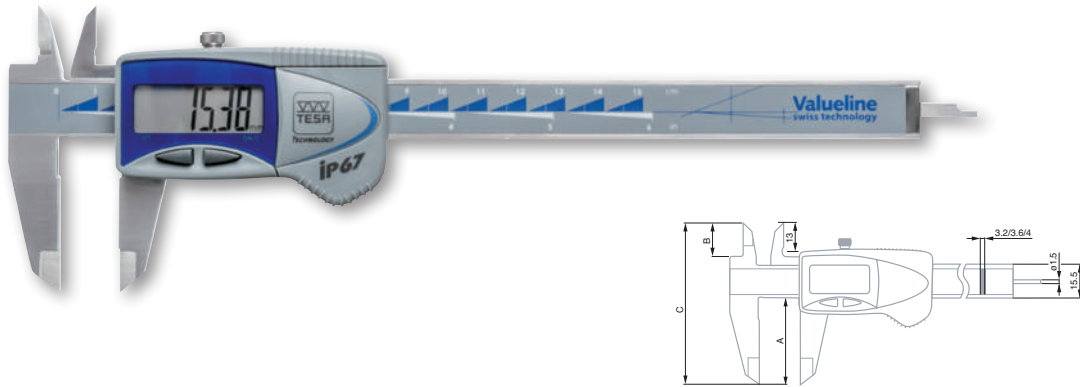

	mm	in	Drive system/ thumb roller	A mm	B mm	C mm	g	Depth rod
00539390	150	6	–	40	16	74	150	Square
00539391	150	6	–	40	16	74	150	Round
00539392	200	8	With	50	20	90	200	Square
00539393	300	12	With	64	22	106	280	Square
OPTIONAL ACCESSORIES:								
01961000	Lithium battery, 3V, CR2032							
00560013	Depth foot for calipers up to 150 mm							



DIAL CALIPERS

The dial caliper is the favourite instrument of many professionals working in mechanics, as it is an ideal tool for the workshop.

All dial calipers use the original shockproof technology developed and patented in 1970 by TESA, pioneer of this technology. Thanks to the shockproof system inserted between the mobile measuring element and the mechanism of the dial pointer, this patent guarantees reliable measurements even in case of a shock to the instrument.

Models TESA CCMA-M

Easy-to-read dial calipers – Slider with metal dial housing – Models with a 200 or 300 measuring span are fitted with a thumb roller.

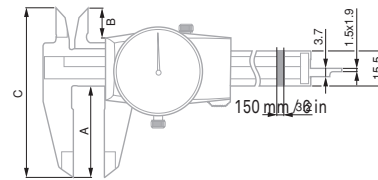
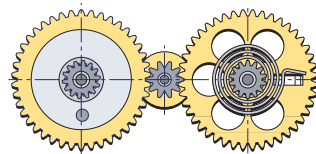
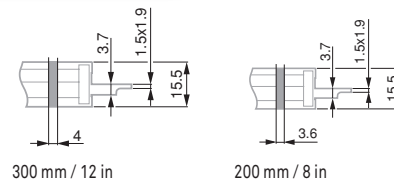
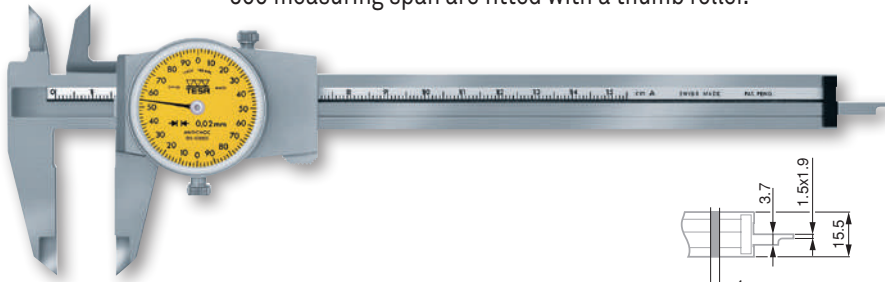

	No	A mm	B mm	C mm	Thumb roller	A mm	B mm	C mm
00510008	0 ÷ 150 mm	0,02 mm	2 mm	-	-	40	13	74
00520002	0 ÷ 6 in	0,001 in	0.1 in	-	-	40	13	74
00510045	0 ÷ 200 mm	0,02 mm	2 mm	●	●	50	18,6	89,5
00510046	0 ÷ 300 mm	0,02 mm	2 mm	●	●	64	20,6	105,5

OPTIONAL ACCESSORY:
00560013 Depth foot for calipers up to 150 mm

Model TESA CCMA-M, 0,01 mm

Slider with metal dial housing – 1 mm per dial revolution.

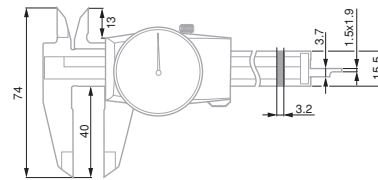
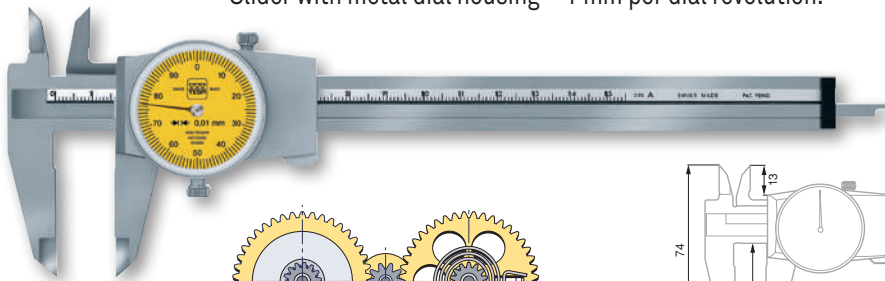

	No	mm	mm	mm
00510050	0 ÷ 150 mm	0,01	mm	1 mm

OPTIONAL ACCESSORY:
00560013 Depth foot for calipers up to 150 mm

- DIN 862 (Style 1AR)
- ≤ 100 mm = 20 µm
>100 mm = 30 µm
- Gear mechanism made of hardened ground steel
- Hardened stainless steel
- Inspection report with a declaration of conformity
- 32 mm diameter rotating dial with lock
- Slider with locking screw
- Patented shockproof design

- DIN 862 (Style 1AR)
- ≤ 100 mm = 20 µm
>100 mm = 30 µm
- Gear mechanism made of hardened ground steel
- Hardened stainless steel
- Inspection report with a declaration of conformity
- 32 mm diameter rotating dial with lock
- Slider with locking screw
- Patented shockproof design

- DIN 862 (Style 1AR)
- ≤ 100 mm = 20 μm
>100 mm = 30 μm
- Gear mechanism made of hardened, ground steel
- Hardened stainless steel
- Inspection report with a declaration of conformity
- 32 mm diameter rotating dial with lock
- Slider with plastic dial housing and locking screw
- Patented shockproof design

TESA CCMA-P Models

Quick and easy to read – Slider with plastic dial housing.

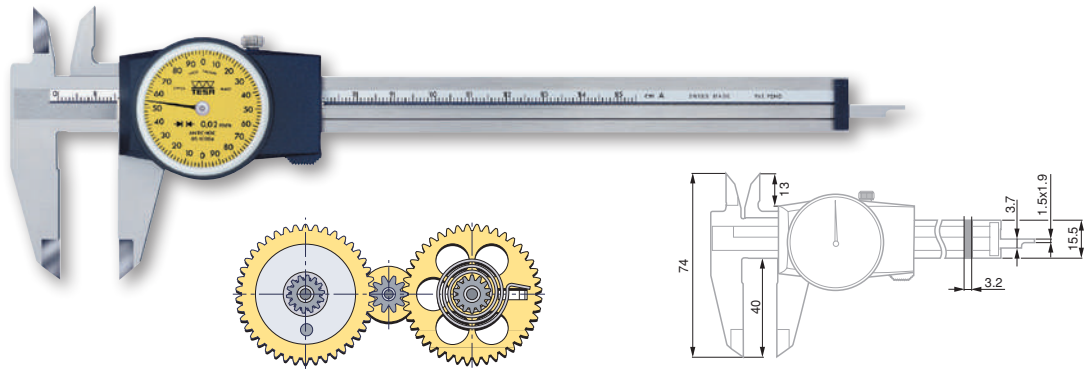

00510004	0 ÷ 150 mm	0,02 mm	2 mm	Without thumb wheel		
00520001	0 ÷ 6 in	0.001 in	0.1 in	Without thumb wheel		
OPTIONAL ACCESSORY:						
00560013	Depth foot for calipers up to 150 mm					

- DIN 862 (Style 1AR)
- ≤ 100 mm = 20 μm
>100 mm = 30 μm
- Gear mechanism made of hardened, ground steel
- Hardened stainless steel
- Inspection report with a declaration of conformity
- 32 mm diameter rotating dial with lock
- Slider with locking screw
- Patented shockproof design

ETALON 125 Model

Slider with metal dial housing – 1 mm travel per dial revolution.

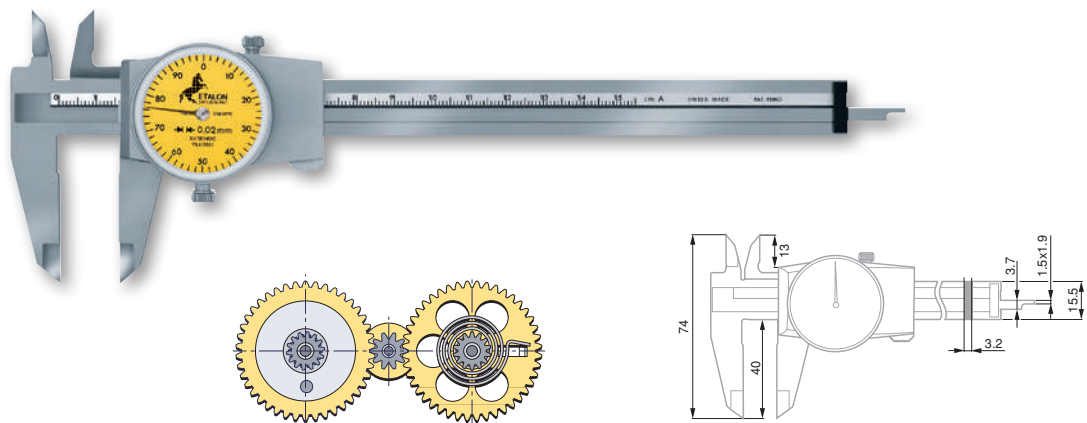

075115821	0 ÷ 150 mm	0,02 mm	1 mm	Without thumb wheel		
OPTIONAL ACCESSORY:						
00560013	Depth foot for calipers up to 150 mm					



ACCESSORIES FOR CALIPERS



Accessories for standard calipers

-  Hardened stainless steel
-  Ground measuring face

Depth Measuring Foot

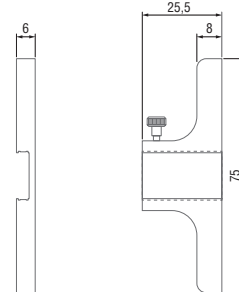
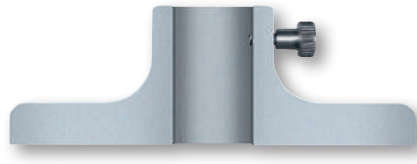
For use with TESA or ETALON universal calipers with a measuring span of 0 to 150 mm / 0 to 6 inch.





		
00560013	Depth foot for calipers up to 150 mm	mm 75 x 6

Magnetic Magnifying Glass

Can be mounted on calipers and other such instruments for easier reading of vernier scales.

-  2 permanent magnets



		
0051610365	Magnetic magnifying glass, 3x magnification	

N DIN 862
(Style 1AN-2)
NFE 11-091

O Maximum
permissible errors,
in accordance with
standard

S Hardened stainless
steel

I Inspection report
with a declaration
of conformity

A Satin-chrome scale
background; main
scale slightly set
back for protection
against wear

VERNIER CALIPERS

The simplest calipers to use with engraved scales for reading very fine divisions on measurements.

Standard Models

Calipers offering great value for money:

- Fitted with a locking screw.
- With rectangular or round depth rod.

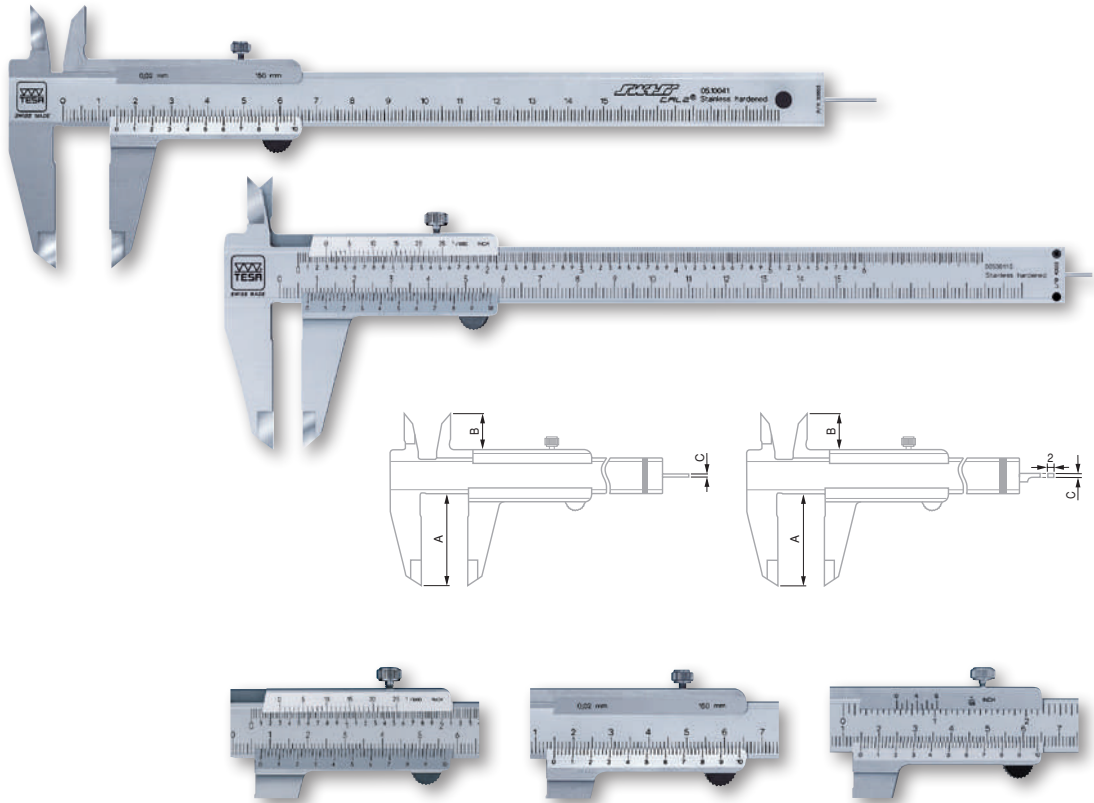

No	=					A mm	B mm	C mm
00510041	SWISSCAL 2	0 ÷ 150	-	0,02	-	40	15,5	Ø 1,5
00510047	Standard	0 ÷ 150	-	0,05	-	40	15,5	Ø 1,5
00530103	Standard	0 ÷ 150	0 ÷ 6	0,05	1/128	40	15,5	Ø 1,5
00530104	Standard	0 ÷ 200	0 ÷ 8	0,05	1/128	50	18	1,5 x 2
00530105	Standard	0 ÷ 300	0 ÷ 12	0,05	1/128	64	22	-
00530110	Standard	0 ÷ 150	0 ÷ 6	0,02	0.001	40	15,5	Ø 1,5
00530111	Standard	0 ÷ 200	0 ÷ 8	0,02	0.001	50	18	1,5 x 2
00530112	Standard	0 ÷ 300	0 ÷ 12	0,02	0.001	64	22	-
00530120	Self-locking model	0 ÷ 150	0 ÷ 6	0,05	1/128	40	15,5	1,5 x 2
00530121	Self-locking model	0 ÷ 150	0 ÷ 6	0,02	0.001	40	15,5	1,5 x 2
00530130	Self-locking model with parallax-free readout	0 ÷ 150	0 ÷ 6	0,05	1/128	40	15,5	1,5 x 2
00530131	Self-locking model with parallax-free readout	0 ÷ 150	0 ÷ 6	0,02	0.001	40	15,5	1,5 x 2

OPTIONAL ACCESSORIES:

00560013 Depth foot for calipers up to 150 mm

0051610365 Magnetic magnifying glass, 3x magnification



WORKSHOP DIGITAL CALIPERS

Large-dimension calipers are equipped with a very precise measuring system and flawless guide of the slider on the beam. This know-how makes them the most accurate calipers available on the market.

The range of IP67 calipers guarantees the highest level of protection against the penetration of dust and liquids. The TLC (TESA Link Connector) system built into all the TwinCal calipers provides the connection of these instruments to a PC for the easy acquisition of measurement data. The unique display housing, protected by a steel plate surrounded with a rubber seal guarantees durability and offers fine sensitivity during measurement.

TWIN-CAL IP67 – Models with Rounded Measuring Faces for Internal Dimensions

- Complete IP67 protection against the penetration of dust and liquids, even when the cable is connected.
- Unique TWIN connectivity concept allowing for upgrade across the range.

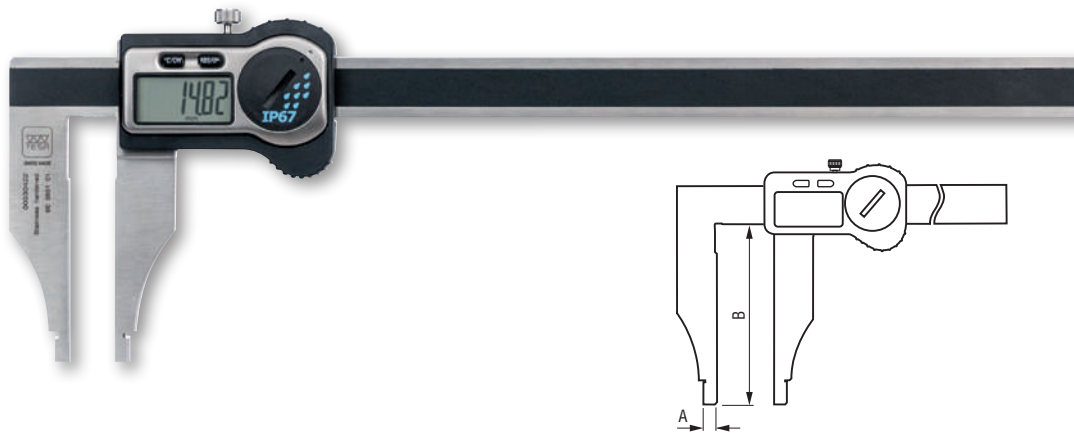

No	mm	in	A mm	B mm
00530421	200	8	5	80
00530422	250	10	5	80
00530423	300	12	5	90
00530424	500	20	10	150
00530425	600	24	10	150
00530426	800	32	10	150
00530427	1000	39	10	150

OPTIONAL ACCESSORIES:

01961000	Lithium battery, 3V, CR2032
04760180	TESA TLC-TWIN wireless emitter-receiver Compatible with any instrument fitted with a TLC – TESA Link Connector
04760181	TESA TLC-USB cable for instruments with a TLC connector
04760182	TLC-DIGIMATIC cable for instruments with a TLC connector

- ISO 13385-1
- 0,01 mm / 0,0005 in
- LCD, 11 mm
- Fixed zero
- mm / in conversion
- L ≤ 100 mm: 30 µm
100 < L ≤ 600 mm: 40 µm
600 < L ≤ 1000 mm: 50 µm
- 10 µm
- Scale with incremental divisions, inductive
- 2,5 m/s
- TLC Connectivity
- Stainless steel
- 3V Lithium battery, CR2032
- 12.000 hours
- Standby mode after 10 minutes, instrument retains the zero position. Automatic shut off after 2 hours, instrument retains the zero in ABS mode, but the zero must be reset if the instrument is in DIFF mode.
- 1907/2006/CE
2004/108/CE
2002/96/CE
- Inspection report with declaration of conformity

- ISO 13385-1
- 0,01 mm / 0.0005 in
- LCD, 11 mm
- Fixed zero
- mm / in conversion
- L ≤ 100 mm: 30 µm
100 < L ≤ 600 mm: 40 µm
600 < L ≤ 1000 mm: 50 µm
- 10 µm
- Scale with incremental divisions, inductive
- 2,5 m/s
- TLC Connectivity
- Stainless steel
- 3V Lithium battery, CR2032
- 12.000 hours
- Standby mode after 10 minutes, instrument retains the zero position. Automatic shut off after 2 hours, instrument retains the zero in ABS mode, but the zero must be reset if the instrument is in DIFF mode.
- 1907/2006/CE
2004/108/CE
2002/96/CE
- Inspection report with declaration of conformity

TWIN-CAL IP67 – Models with Rounded Measuring Faces for Internal Dimensions and Knife-edge Jaws for External Dimensions

- Complete IP67 protection against the penetration of dust and liquids, even when the cable is connected
- Unique TWIN connectivity concept allowing for upgrade across the range.

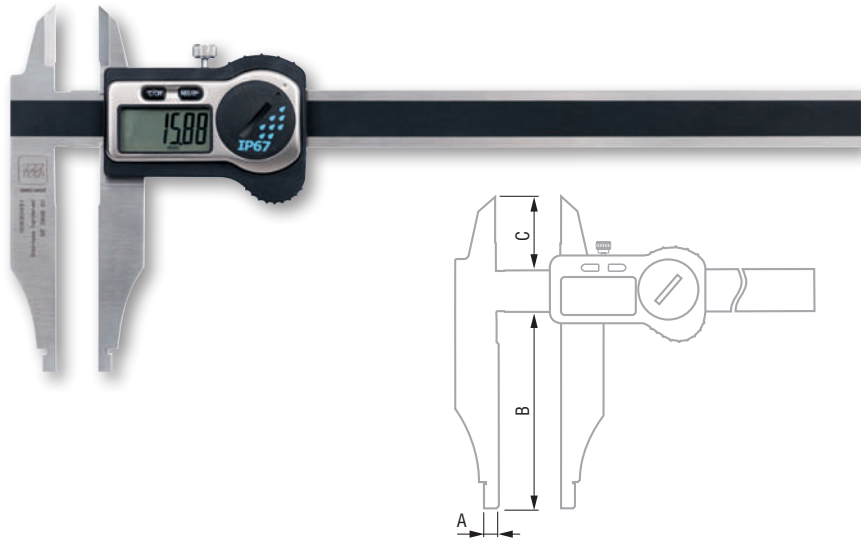

No					
	mm	in	A mm	B mm	C mm
00530431	200	8	5	80	30
00530432	250	10	5	80	37
00530433	300	12	5	90	37
00530434	500	20	10	150	60
00530435	600	24	10	150	60
00530436	800	32	10	150	56
00530437	1000	39	10	150	56

OPTIONAL ACCESSORIES:

01961000	Lithium battery, 3V, CR2032
04760180	TESA TLC-TWIN wireless emitter-receiver Compatible with any instrument fitted with a TLC – TESA Link Connector
04760181	TESA TLC-USB cable for instruments with a TLC connector
04760182	TLC-DIGIMATIC cable for instruments with a TLC connector



TWIN-CAL IP67 – Models with Rounded Measuring Faces for Internal Dimensions and Knife-edge Jaws for Internal Dimensions

- Complete IP67 protection against the penetration of dust and liquids, even when the cable is connected
- Unique TWIN connectivity concept allowing for upgrade across the range.

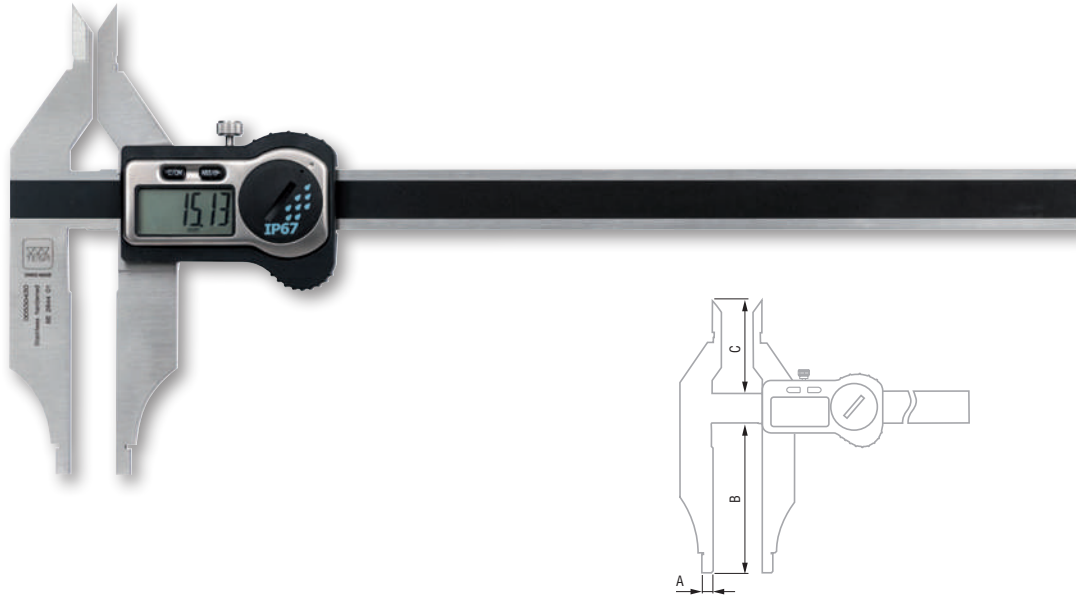

No	mm	in	A mm	B mm	C mm
00530430	250	10	5	80	54
OPTIONAL ACCESSORIES:					
01961000	Lithium battery, 3V, CR2032				
04760180	TESA TLC-TWIN wireless emitter-receiver Compatible with any instrument fitted with a TLC – TESA Link Connector				
04760181	TESA TLC-USB cable for instruments with a TLC connector				
04760182	TLC-DIGIMATIC cable for instruments with a TLC connector				

- ISO 13385-1
- 0,01 mm / 0.0005 in
- LCD, 11 mm
- Fixed zero
- mm / in conversion
- L ≤ 100 mm: 30 µm
100 < L ≤ 250 mm: 40 µm
- 10 µm
- Scale with incremental divisions, inductive
- 2,5 m/s
- TLC Connectivity
- Stainless steel
- 3V Lithium battery, CR2032
- 12.000 hours
- Standby mode after 10 minutes, instrument retains the zero position. Automatic shut off after 2 hours, instrument retains the zero in ABS mode, but the zero must be reset if the instrument is in DIFF mode.
- 1907/2006/CE
2004/108/CE
2002/96/CE
- Inspection report with declaration of conformity

- DIN 862 (Style EN-2) NFE 11-091
- Maximum permissible errors in accordance with standard
- Hardened stainless steel
- Inspection report with a declaration of conformity
- Satin-chrome scale background; main scale set back slightly for protection against wear.

VERNIER CALIPERS

The simplest calipers to use with engraved scales for reading very fine divisions on measurements.

Models with Rounded Measuring Faces for Internal Dimensions (Without Fine Adjust Device)

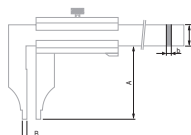
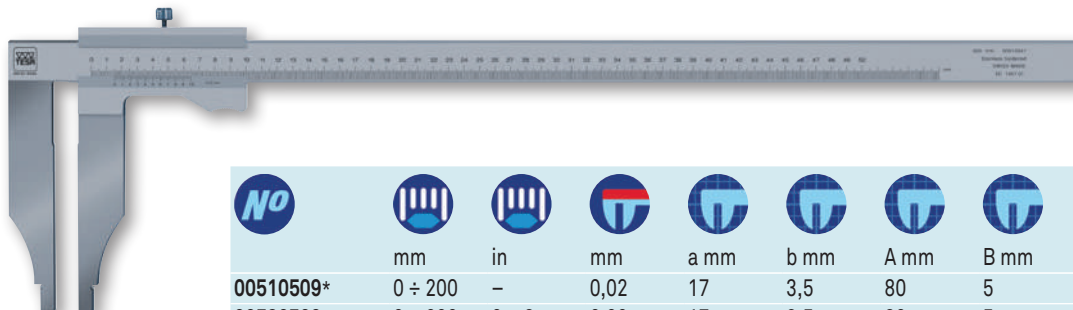

No							
	mm	in	mm	a mm	b mm	A mm	B mm
00510509*	0 ÷ 200	–	0,02	17	3,5	80	5
00530509	0 ÷ 200	0 ÷ 8	0,02	17	3,5	80	5
00510506	0 ÷ 200	–	0,05	17	3,5	80	5
00510511	0 ÷ 250	–	0,02	20	4	90	5
00510512	0 ÷ 250	–	0,05	20	4	90	5
00510521	0 ÷ 300	–	0,02	20	4	90	5
00530521	0 ÷ 300	0 ÷ 12	0,02	20	4	90	5
00510522	0 ÷ 300	–	0,05	20	4	90	5
00510531	0 ÷ 400	–	0,02	24,5	5	125	10
00530531	0 ÷ 400	0 ÷ 15	0,02	24,5	5	125	10
00510541	0 ÷ 500	–	0,02	28	6	150	10
00510542	0 ÷ 500	–	0,05	28	6	150	10
00510551	0 ÷ 600	–	0,02	28	6	150	10

OPTIONAL ACCESSORY:

0051610365 Magnetic magnifying glass, 3x magnification

* Supplied with a flexible stainless steel rule, 200 mm long, part code 0951750181

- DIN 862 (Style EN-2F) NFE 11-091
- Maximum permissible errors in accordance with standard
- Hardened stainless steel
- Inspection report with a declaration of conformity
- Satin-chrome scale background; main scale set back slightly for protection against wear

Models with Rounded Measuring Faces for Internal Dimensions (With Fine Adjust Device)

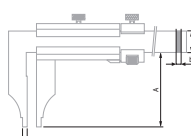
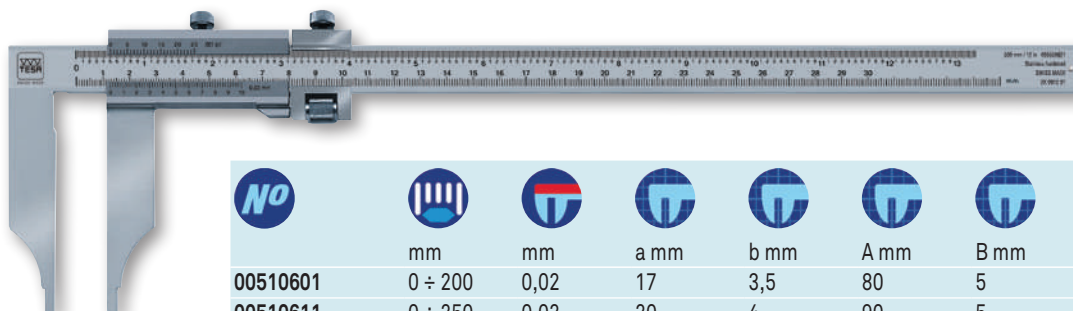

No						
	mm	mm	a mm	b mm	A mm	B mm
00510601	0 ÷ 200	0,02	17	3,5	80	5
00510611	0 ÷ 250	0,02	20	4	90	5
00510621	0 ÷ 300	0,02	20	4	90	5
00510641	0 ÷ 500	0,02	28	6	150	10
00510651	0 ÷ 600	0,02	28	6	150	10
00510661	0 ÷ 800	0,02	32	8	150	10
00510671	0 ÷ 1000	0,02	32	8	150	10
00510681	0 ÷ 1500	0,02	40	8	300	15
00510691	0 ÷ 2000	0,02	40	8	300	15

OPTIONAL ACCESSORY:

0051610365 Magnetic magnifying glass, 3x magnification



Models with Knife-edge Jaws for External Dimensions and Rounded Measuring Faces for Internal Dimensions (Without Fine Adjust Device)

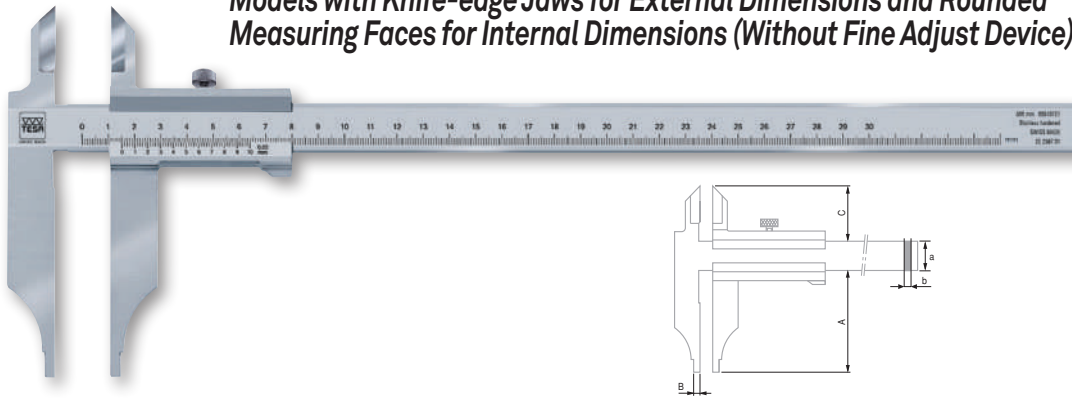

- DIN 862 (Style BN-2) NFE 11-091
- Maximum permissible errors, in accordance with standard
- Hardened stainless steel
- Inspection report with a declaration of conformity
- Satin-chrome scale background: main scale set back slightly for protection against wear

No	mm	in	mm	a mm	b mm	A mm	B mm	C mm
00510701	0 ÷ 200	–	0,02	17	3,5	80	5	30
00530701	0 ÷ 200	0 ÷ 8	0,02	17	3,5	80	5	30
00510711	0 ÷ 250	–	0,02	20	4	80	5	38
00510721	0 ÷ 300	–	0,02	20	4	90	5	38
00530721	0 ÷ 300	0 ÷ 12	0,02	20	4	90	5	38
00510722	0 ÷ 300	–	0,05	20	4	90	5	38
00510741	0 ÷ 500	–	0,02	28	6	150	10	60
00530741	0 ÷ 500	0 ÷ 20	0,02	28	6	150	10	60
00510751	0 ÷ 600	–	0,02	28	6	150	10	60

OPTIONAL ACCESSORY:

0051610365 Magnetic magnifying glass, 3x magnification

Models with Knife-edge Jaws for External Dimensions and Rounded Measuring Faces for Internal Dimensions (With Fine Adjust Device)

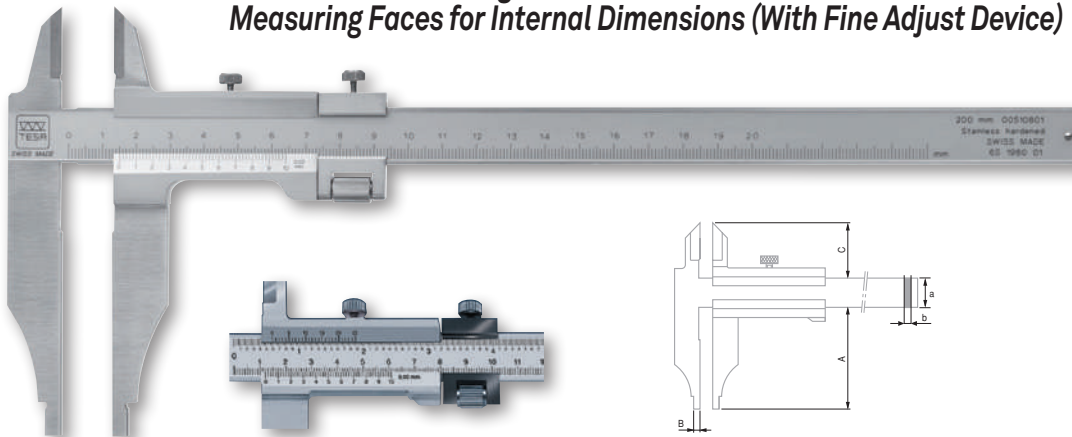

- DIN 862 (Style BN-2) NFE 11-091
- Maximum permissible errors, in accordance with standard
- Hardened stainless steel
- Inspection report with a declaration of conformity
- Satin-chrome scale background: main scale set back slightly for protection against wear

No	mm	in	mm	a mm	b mm	A mm	B mm	C mm
00510801	0 ÷ 200	–	0,02	17	3,5	80	5	30
00510821	0 ÷ 300	–	0,02	20	4	90	5	38
00530821	0 ÷ 300	0 ÷ 11	0,02	20	4	90	5	38
00510841	0 ÷ 500	–	0,02	28	6	150	10	60
00530841	0 ÷ 500	0 ÷ 20	0,02	28	6	150	10	60
00510861	0 ÷ 800	–	0,02	32	8	150	10	56
00510871	0 ÷ 1000	–	0,02	32	8	150	10	56

OPTIONAL ACCESSORY:

0051610365 Magnetic magnifying glass, 3x magnification

- ISO 13385-1
- 0,01 mm / 0,0005 in
- LCD, 11 mm
- Fixed zero
- mm / in conversion
- L ≤ 100 mm: 30 µm
100 < L ≤ 600 mm: 40 µm
600 < L ≤ 1000 mm: 50 µm
- 10 µm
- Scale with incremental divisions, inductive
- 2,5 m/s
- TLC Connectivity
- Stainless steel
- 3V lithium battery, CR2032
- 12.000 hours
- Standby mode after 10 minutes, instrument retains the zero position. Automatic shut off after 2 hours, instrument retains the zero in ABS mode, but the zero must be reset if the instrument is in DIFF mode.
- 1907/2006/CE
2004/108/CE
2002/96/CE
- Inspection report with declaration of conformity

DIGITAL DEPTH CALIPERS

The range of IP67 calipers guarantees the highest level of protection against the penetration of dust and liquids. The TLC (TESA Link Connector) system built into all the TWIN-CAL calipers provides the connection of these instruments to a PC for the easy acquisition of measurement data. The unique display housing, protected by a steel plate surrounded with a rubber seal guarantees durability and offers fine sensitivity during measurement.

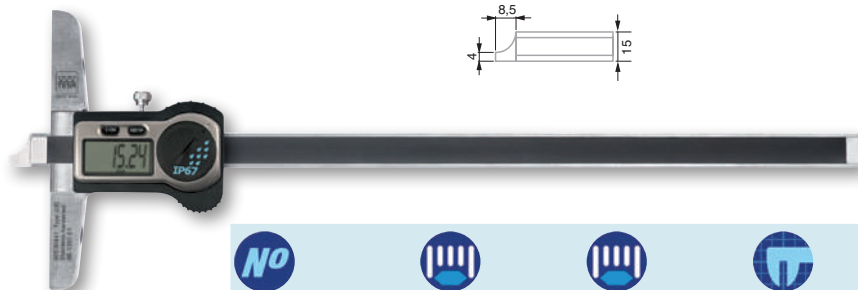
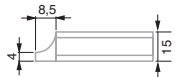
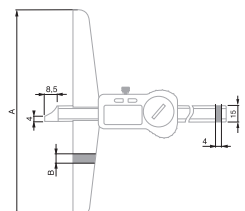

TWIN-CAL IP67 – Models with Short Cut Measuring Face

No	mm	in	A mm	B mm
00530441	200	8	100	8
00530442	250	10	100	8
00530443	300	12	150	8
00530444	500	20	150	8

TWIN-CAL IP67 – Models with One Fixed Measuring Jaw

No	mm	in	A mm	B mm
00530445	300	12	150	8
00530446	500	20	150	8

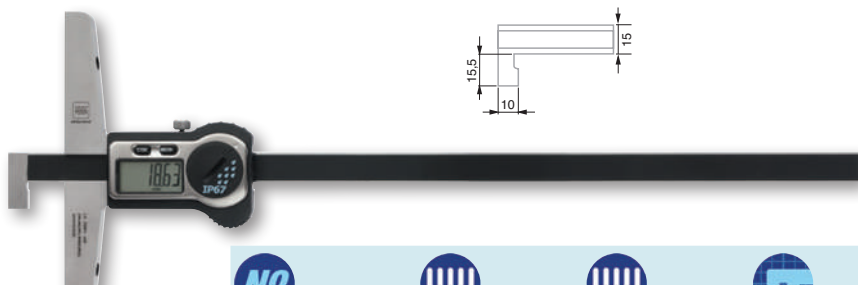
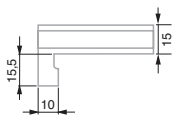
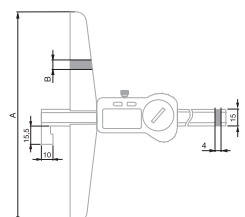
TWIN-CAL IP67 – Models with Two Fixed Measuring Jaws

No	mm	in	A mm	B mm
00530447	300	12	150	8

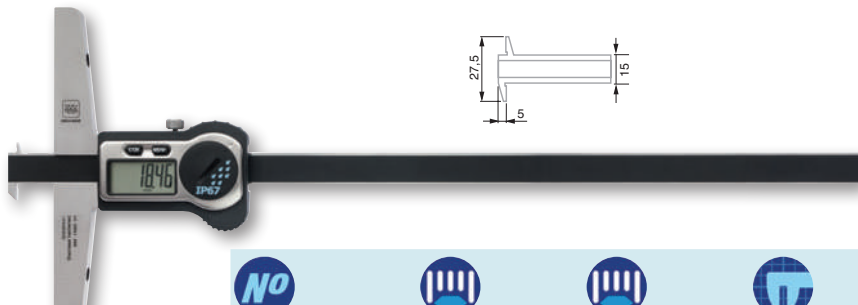
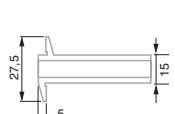
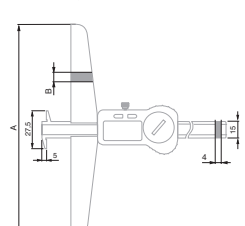

TWIN-CAL IP67 – Models with Rotary Stop Plate

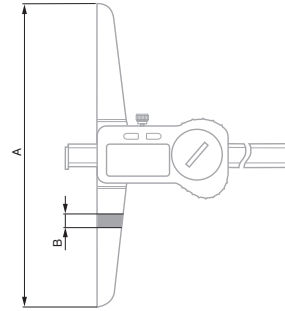
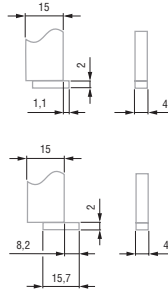
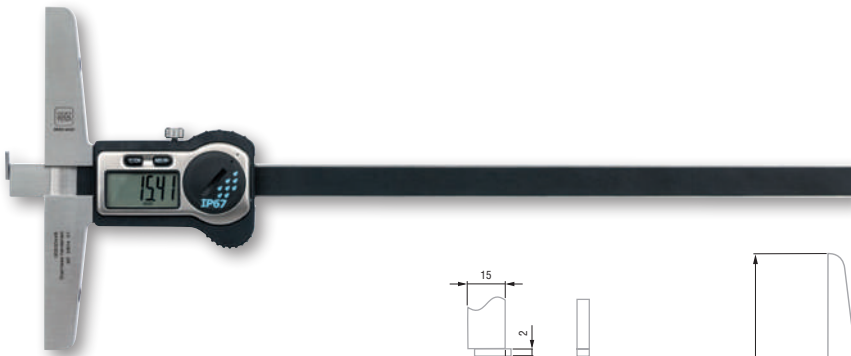

No	mm	in	A mm	B mm
00530448	250	10	150	8,5
00530449	350	14	150	8,5
00530450	500	20	150	8,5

OPTIONAL ACCESSORIES:

01961000	Lithium battery, 3V, CR2032
04760180	TESA TLC-TWIN wireless emitter-receiver Compatible with any instrument fitted with a TLC – TESA Link Connector
04760181	TESA TLC-USB cable for instruments with a TLC connector
04760182	TLC-DIGIMATIC cable for instruments with a TLC connector
00560103	Removable bridge 200 mm
00560104	Removable bridge 300 mm
00560105	Removable bridge 400 mm

TWIN-CAL IP67 – Small Sized Model with Steel Measuring Tip

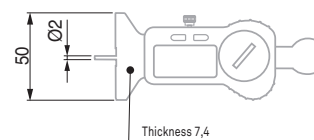

No	mm	in
00530451	25	1

OPTIONAL ACCESSORIES:

01961000	Lithium battery, 3V, CR2032
04760180	TESA TLC-TWIN wireless emitter-receiver Compatible with any instrument fitted with a TLC – TESA Link Connector
04760181	TESA TLC-USB cable for instruments with a TLC connector
04760182	TLC-DIGIMATIC cable for instruments with a TLC connector

- ISO 13385-1
- 0.01 mm / 0.0005 in
- LCD, 11 mm
- Fixed zero
- Metric / in conversion
- L ≤ 100 mm: 30 µm
100 < L ≤ 600 mm: 40 µm
600 < L ≤ 1000 mm: 50 µm
- 10 µm
- Scale with incremental divisions, inductive
- 2,5 m/s
- TLC Connectivity
- Stainless steel
- 3V lithium battery, CR2032
- 12.000 hours
- Standby mode after 10 minutes, instrument retains the zero position. Automatic shut off after 2 hours, instrument retains the zero in ABS mode, but the zero must be reset if the instrument is in DIFF mode.
- 1907/2006/CE
2004/108/CE
2002/96/CE
- Inspection report with declaration of conformity

- DIN 862 (Style C-2) NFE 11-096
- Maximum permissible errors: in accordance with standard
- Hardened stainless steel
- Inspection report with a declaration of conformity
- Satin-chrome scale background; main scale set back slightly for protection against wear

VERNIER DEPTH CALIPERS

Depth calipers with:

- Flat measuring face
- Convertible models, short cut measuring face or steel tip
- Rotary stop plate
- Convertible models, short cut measuring face or fixed hook



TESA Vernier Calipers with a Flat Measuring Face

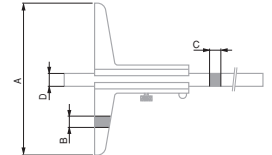

No							
	mm	mm	A mm	B mm	C mm	D mm	
00510133	0 ÷ 150	0,02	100	7,5	3	8	
00510134	0 ÷ 150	0,05	100	7,5	3	8	
00510143	0 ÷ 250	0,02	100	7,5	3	8	
00510163	0 ÷ 500	0,02	100	8,5	4	12	
00510173	0 ÷ 600	0,02	150	8,5	4	12	

- DIN 862 (Style C-2) NFE 11-096
- Maximum permissible errors: in accordance with standard
- Hardened stainless steel
- Inspection report with a declaration of conformity
- Satin-chrome scale background; main scale set back slightly for protection against wear

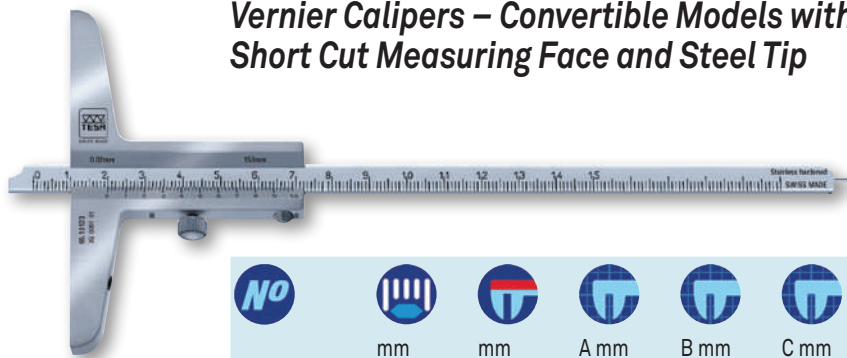

Vernier Calipers – Convertible Models with Short Cut Measuring Face and Steel Tip

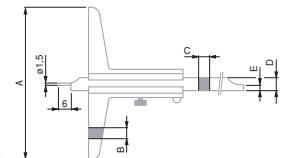

No								
	mm	mm	A mm	B mm	C mm	D mm	E mm	
00510123	0 ÷ 150	0,02	100	7,5	3	8	3,5	
00510124	0 ÷ 150	0,05	100	7,5	3	8	3,5	
00510125	0 ÷ 250	0,02	100	7,5	3	8	4	



Vernier Calipers with Rotary Stop Plate

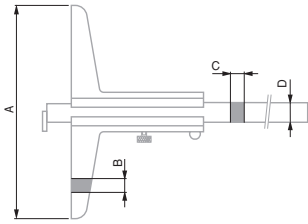
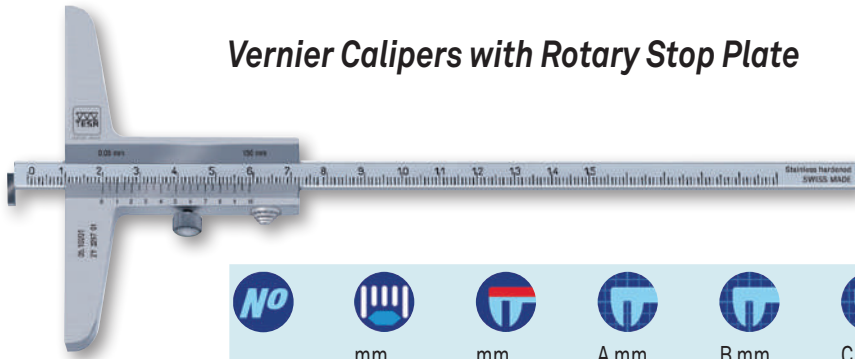

No						
	mm	mm	A mm	B mm	C mm	D mm
00510201	0 ÷ 150	0,05	130	8,5	4	12
00510202	0 ÷ 150	0,02	130	8,5	4	12
00510212	0 ÷ 250	0,02	130	8,5	4	12
00510222	0 ÷ 500	0,02	130	8,5	4	12

OPTIONAL ACCESSORIES:

0051610365	Magnetic magnifying glass, 3x magnification
00560103	Removable bridge 200 mm
00560104	Removable bridge 300 mm
00560105	Removable bridge 400 mm

Vernier Calipers – Convertible Models with Fixed Stop Plate and Short Cut Measuring Face

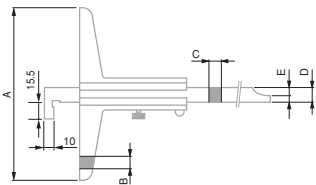

No							
	mm	mm	A mm	B mm	C mm	D mm	E mm
00510175	0 ÷ 150	0,02	100	7,5	3	8	3,5
00510177	0 ÷ 250	0,02	130	8,5	4	12	4
00510179	0 ÷ 300	0,02	150	8,5	4	12	4
00510181	0 ÷ 500	0,02	150	8,5	4	12	4

OPTIONAL ACCESSORIES:

0051610365	Magnetic magnifying glass, 3x magnification
00560103	Removable bridge 200 mm
00560104	Removable bridge 300 mm
00560105	Removable bridge 400 mm

Removable Bridges



Each bridge is delivered with the appropriate fixing screws

No						
	mm	µm	mm	A mm	B mm	C mm
00560103	± 0,005	8	0,02	200	11,5	10
00560104	± 0,005	10	0,02	300	16	16
00560105	± 0,005	10	0,03	400	16	16

- DIN 862 (Style C-2) NFE 11-096
- Maximum permissible errors: in accordance with standard
- Hardened stainless steel
- Inspection report with a declaration of conformity
- Satin-chrome scale background; main scale set back slightly for protection against wear

- DIN 862 (Style C-2) NFE 11-096
- Maximum permissible errors, in accordance with standard
- Hardened stainless steel
- Inspection report with a declaration of conformity
- Satin-chrome scale background; main scale set back slightly for protection against wear



ISO 13385-1

0,01 mm /
0,0005 in

LCD, 11 mm

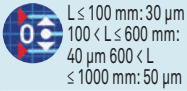

Fixed zero

mm / in
conversionL ≤ 100 mm: 30 μm
100 < L ≤ 600 mm:
40 μm
600 < L
≤ 1000 mm: 50 μm

10 μm

Scale with incre-
mental divisions,
inductive

2,5 m/s



TLC Connectivity



Stainless steel

3V Lithium battery,
CR2032

12.000 hours

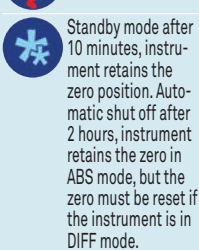
Standby mode after
10 minutes, instru-
ment retains the
zero position. Auto-
matic shut off after
2 hours, instrument
retains the zero in
ABS mode, but the
zero must be reset if
the instrument is in
DIFF mode.1907/2006/CE
2004/108/CE
2002/96/CEInspection report
with declaration
of conformity

SCALE UNITS

The IP67 scale units assure the highest degree of protection against the penetration of dust and liquids.





The integral TLC (TESA Link Connector) connectivity system common to the all the TWIN-CAL range allows the connection of all these instruments to a PC for easy data acquisition.

The unique display module, protected by a steel plate surrounded by rubber seal guarantees optimal durability and sensitivity during measurement.

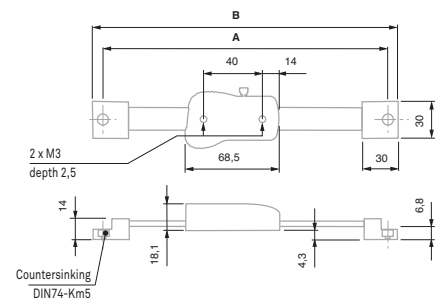
TWIN-CAL IP67 Horizontal Scale Unit

- Complete IP67 protection against the penetration of dust and liquids, even when the cable is connected
- Unique TWIN connectivity concept allowing for upgrade across the range



No				
00530471	150	6	265	278
00530473	300	12	415	428
00530474	600	24	725	738
00530475	1000	40	1135	1148

OPTIONAL ACCESSORIES:

01961000	Lithium battery, 3V, CR2032
04760180	TESA TLC-TWIN wireless emitter-receiver Compatible with any instrument fitted with a TLC – TESA Link Connector
04760181	TESA TLC-USB cable for instruments with a TLC connector
04760182	TLC-DIGIMATIC cable for instruments with a TLC connector



DIGITAL CALIPERS

For measurements up to 3000 mm.

INTERAPID Light

Measuring functions

- Zero setting
- Metric/Inch conversion
- Hold function for displayed value
- OPTO-RS data transfer, mono- and bi-directional
- Two adjustable points of origin (Ref I / Ref II)
- PRESET function
- MIN/MAX mode
- Two limit values for classification

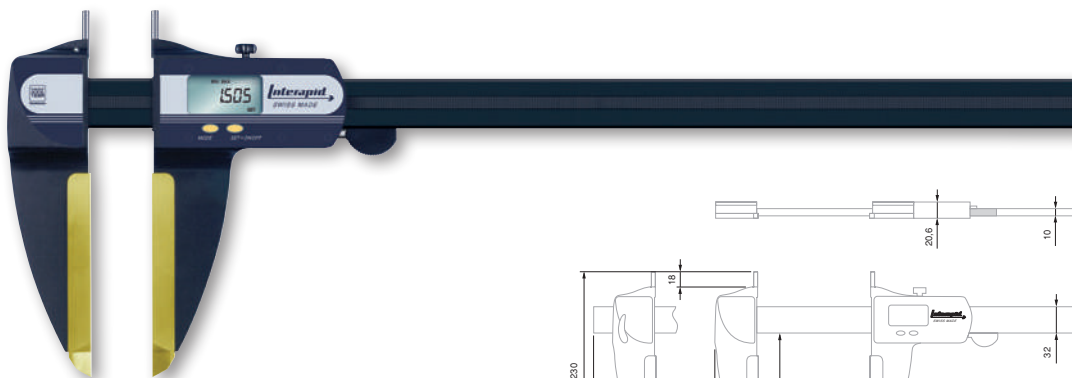

- DIN 862 and factory standard
- 0.01 mm / 0.0005 in
- LCD, 8,5 mm
- Fixed zero
- mm / in conversion
- Scale with incremental divisions, inductive
- > 1,5 m/s
- Hardened steel jaws for external dimensions. Also with TiN coating, thickness to 7 mm. Tungsten carbide inserts for internal dimensions, 5 mm dia. Beam with light alloy hollow section, supported by hardened stainless steel rods.
- 3V lithium battery, CR2032
- ≈ 1,5 a (≈ 3300 h / a)
- IP40 (IEC 60529)
- EN 50081-1
EN 50082-1
- Inspection report for models up to 1500 mm
- Display lock
- RS232 Opto-coupled, mono- and bi-directional

No						
	A mm	μm	μm	B Fixed	C Mobile	kg
00590061	330	30	20	618	-	1,1
00590062	630	40	20	918	-	1,3
00590063	1025	60	20	-	1306	1,6
00590064	1525	150	20	-	1806	2
00590065	2040	250	30	-	2306	2,3
00590066	2545	350	30	-	2806	2,6
00590067	3050	450	40	-	3306	3

OPTIONAL ACCESSORIES:

01961000	Lithium battery, 3V, CR2032
00560095	Insert-holder, M2,5 thread
00560096	60°conical steel pin in hardened steel
00560097	Holder for dial gauge inserts L = 28 mm
00560098	Holder for dial gauge inserts L = 58 mm
00560099	Wooden case for INTERAPID Light 300 mm
00560100	Wooden case for INTERAPID Light 600 mm
00560101	Wooden case for INTERAPID Light 1000 mm
00560102	Wooden case for INTERAPID Light 1500 mm

Accessories for INTERAPID Light

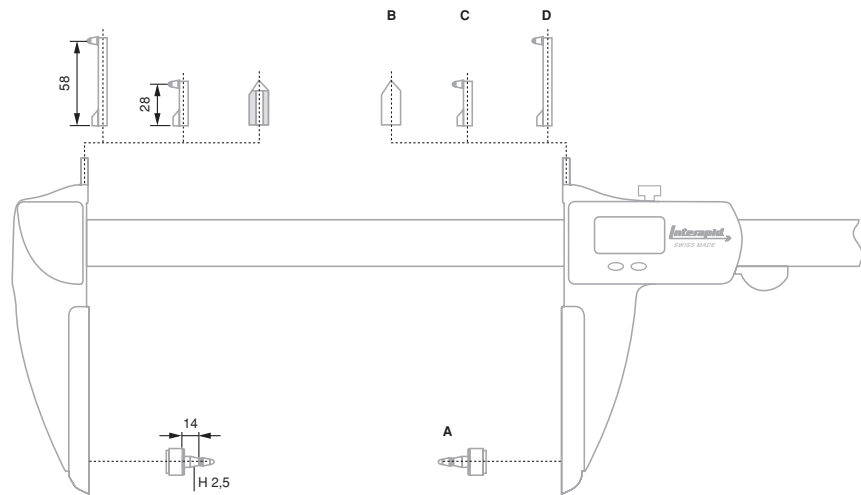

No	=	A
00560095	Insert-holder, M2,5 thread for measuring inserts	A
00560096	60° conical steel pin in hardened steel for measuring centre distances >10 mm	B
00560097	Holder for dial gauge inserts used for groove measurement, L = 28 mm	C
00560098	Holder for dial gauge inserts used for groove measurement, L = 58 mm	D
00560099	Wooden case for INTERAPID Light 300 mm	
00560100	Wooden case for INTERAPID Light 600 mm	
00560101	Wooden case for INTERAPID Light 1000 mm	
00560102	Wooden case for INTERAPID Light 1500 mm	



CALIPERS WITH SPECIAL DESIGN

Calipers designated for specific measuring tasks including:

- Models with extra long jaws
- Models with hook jaws for measuring grooves
- Models for measuring throat depth

- Factory standard
- Hardened stainless steel
- Inspection report with a declaration of conformity
- Satin-chrome scale background; main scale set back slightly for protection against wear

With Extra Long Jaws and Fine Adjust Device

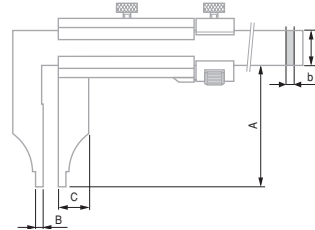
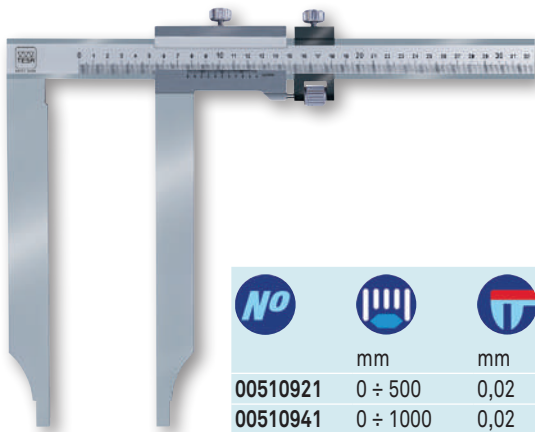

No								
	mm	mm	a mm	b mm	A mm	B mm	C mm	
00510921	0 ÷ 500	0,02	28	6	250	10	30	
00510941	0 ÷ 1000	0,02	32	8	300	10	30	

OPTIONAL ACCESSORY:

0051610365 Magnetic magnifying glass, 3x magnification

With Hook Jaws for External Dimensions

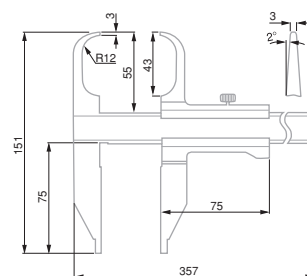
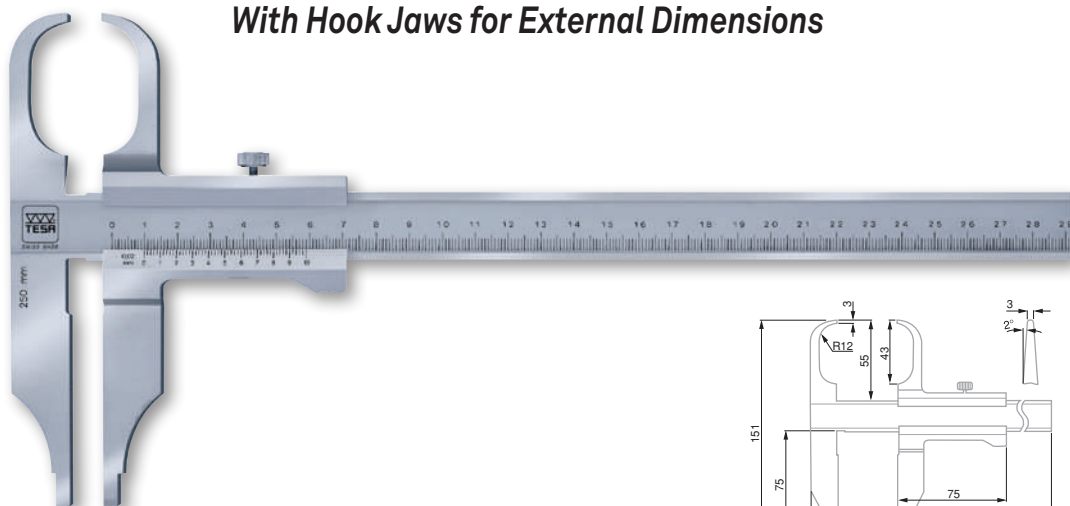

No		
	mm	mm
00510911	0 ÷ 250	0,02

OPTIONAL ACCESSORY:

0051610365 Magnetic magnifying glass, 3x magnification

- NFE 11-096
- Hardened stainless steel
- inspection report with declaration of conformity
- Satin-chrome scale background; main scale set back slightly for protection against wear

- DIN 862
(Style DN-2)
NFE 11-091
- Hardened stainless steel
- Inspection report with a declaration of conformity
- Satin-chrome scale background; main scale set back slightly for protection against wear

With Knife-edge Jaws for Internal Dimensions

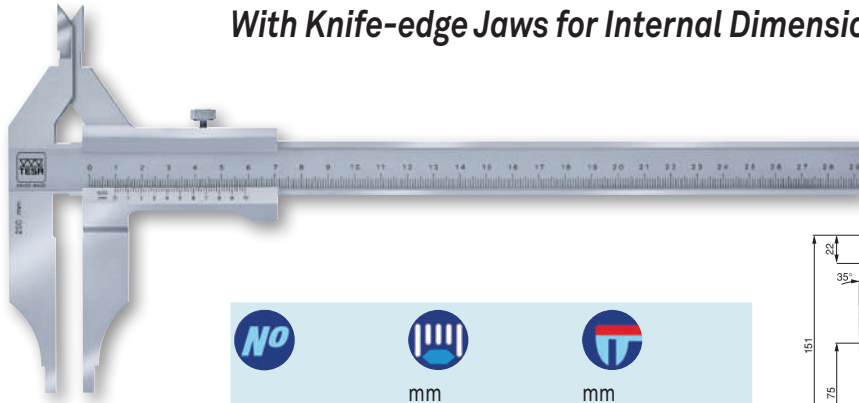

00510915	mm 0 ÷ 250	mm 0,02

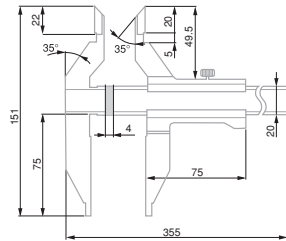

- NFE 11-096
- Hardened stainless steel
- Inspection report with a declaration of conformity
- Satin-chrome scale background; main scale set back slightly for protection against wear

With Vee Bridge

Made to measure groove and slot depths on cylindrical shafts.

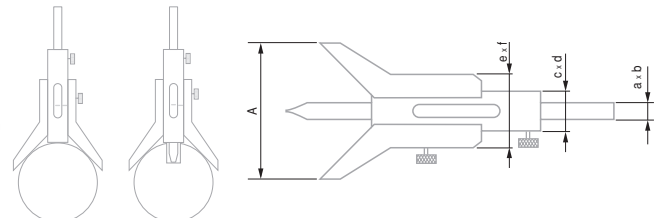
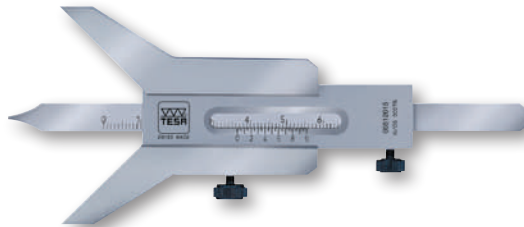

No										
	mm	mm	a mm	b mm	c mm	d mm	e mm	f mm	A mm	
00512015	5 ÷ 80	0,05	8	2	18	5	32	10	60	
00512016	6 ÷ 120	0,05	8	2	18	5	34	10	90	
00512017	7 ÷ 160	0,05	10	2	21,5	5	42	10	120	

- Factory standard
- Hardened stainless steel
- Inspection report with a declaration of conformity
- Satin-chrome scale background; main scale set back slightly for protection against wear

For Turned Grooves

Specially designed for measuring groove or slot diameters, e.g. on safety rings.

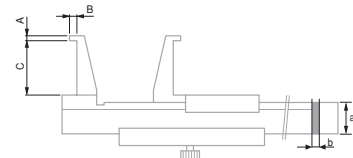
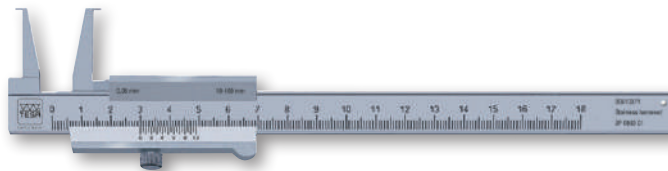

No							
	mm	mm	a mm	b mm	A mm	B mm	C mm
00510371	10 ÷ 160	0,05	16	3	0,9	3	25
00510375	20 ÷ 160	0,05	16	3	2	5	40
00510383	26 ÷ 200	0,02	16	3	3	7	60
00510387	30 ÷ 250	0,02	20	4	4	8,5	80
00510393	35 ÷ 300	0,02	20	4	5	10	100





External Micrometers







PRECISION MEASUREMENT

Precision measurement requires the use of micrometers. In 1848, the first measuring tool of this type was patented by the French inventor Jean Laurent Palmer as "calibre à vis et à vernier circulaire" (screw caliper with a circular vernier). Today, we continue to make external micrometers with these typical features. The introduction of the micrometer to the mechanical world came about due to the visit of the two American engineers, Joseph R. Brown and Lucian Sharpe to the Paris Exhibition in 1867. At that time, their attention was drawn to Palmer's invention, which greatly interested them. After some improvements of Palmer's design, the product was manufactured on a large scale and marketed successfully by the two partners. History repeated itself years later as TESA SA decided to manufacture external micrometers, making them the first products produced by the company.

Whether for internal or external measurement, TESA micrometers are distinguishable for their construction and quality. All our models respect the ABBE principle with the exception of the models with large measuring anvils for the measurement of gear teeth for example.

Max. permissible errors

			
Measuring range mm	Maximum permissible errors* μm	Number of interference fringes or rings	μm
0 ÷ 25	4	6	2
25 ÷ 50	4	6	2
50 ÷ 75	5	10	3
75 ÷ 100	5	10	3
100 ÷ 125	6		3
125 ÷ 150	6		3
150 ÷ 175	7		4
175 ÷ 200	7		4
200 ÷ 225	8		4
225 ÷ 250	8		4
250 ÷ 275	9		5
275 ÷ 300	9		5
300 ÷ 325	10		5
325 ÷ 350	10		5
350 ÷ 375	11		6
375 ÷ 400	11		6
400 ÷ 425	12		6
425 ÷ 450	12		6
450 ÷ 475	13		7
475 ÷ 500	13		7

* Including the errors of the measuring element as well as any deviations in the flatness and parallelism of the measuring faces, plus any errors due to the flexing of the frame.

State of the art machining techniques are used for grinding the micrometer spindles, to ensure extreme accuracy and a true reproduction of the thread with negligible pitch deviations. For this reason we can guarantee a very low measuring uncertainty to our instrument users. TESA micrometers are designed to meet the most exacting demands. They are robust and ergonomically designed.

We offer an extensive range of micrometers, from a classic model through to micrometers for special applications, and also micrometer heads, complete sets, accessories and all items needed for calibration. They are available in analogue or digital versions, and also digital versions with results output.

 DIN 863 T1

 0,001 mm /
0.00005 in

 LCD, digit height:
7 mm



 Floating zero



 Conversion
mm/in

 Tungsten carbide
tipped

 3V lithium battery

 1 to 2 a (≈ 2000 h/a)

 Automatic shut-
down after 10 min.
Display setting is
maintained as long
as power supply
remains stable.

 Protection as per
IEC 60529: IP40
(also valid with used
RS data output)
or IP54

 Measuring range
0 to 100: with
SCS calibration
certificate



 Measuring range
> 100 mm : with
inspection report
and declaration
of conformity

 Display lock (except
for model EASY)

 RS232 interface,
opto-coupled

 0,5 mm

 Max. 10 N







 ≤ 100 mm: Ø 6,5 mm
> 100 mm: Ø 8 mm

TESA MICROMASTER Electronic Micrometers with Digital Display

With patented TESA CAPA μ SYSTEM.

- Measuring span of 30 mm.
- Large easy-to-read digital display.
- Models:
 - EASY IP40 with a single function key.
 - IP54 with water spray protection as well as IP54 RS with an RS232 interface.





No						
06030010	0 ÷ 30	0 ÷ 30	0 ÷ 1.2	0 ÷ 1.2	IP40	-
06030020	0 ÷ 30	0 ÷ 30	0 ÷ 1.2	0 ÷ 1.2	IP54	-
06030021	25 ÷ 50	23 ÷ 53	1 ÷ 2	0.9 ÷ 2.1	IP54	-
06030022	50 ÷ 75	48 ÷ 78	2 ÷ 3	1.9 ÷ 3.1	IP54	-
06030023	75 ÷ 100	74 ÷ 104	3 ÷ 4	2.9 ÷ 4.1	IP54	-
06030030	0 ÷ 30	0 ÷ 30	0 ÷ 1.2	0 ÷ 1.2	IP54	RS232
06030031	25 ÷ 50	23 ÷ 53	1 ÷ 2	0.9 ÷ 2.1	IP54	RS232
06030032	50 ÷ 75	48 ÷ 78	2 ÷ 3	1.9 ÷ 3.1	IP54	RS232
06030033	75 ÷ 100	74 ÷ 104	3 ÷ 4	2.9 ÷ 4.1	IP54	RS232
06030071	100 ÷ 125	98 ÷ 127	4 ÷ 5	3.9 ÷ 5.01	IP54	RS232
06030072	125 ÷ 150	123 ÷ 152	5 ÷ 6	4.9 ÷ 6.01	IP54	RS232
06030073	150 ÷ 175	149 ÷ 178	6 ÷ 7	5.9 ÷ 7.01	IP54	RS232
06030074	175 ÷ 200	174 ÷ 203	7 ÷ 8	6.9 ÷ 8.01	IP54	RS232
06030075	200 ÷ 225	199 ÷ 229	8 ÷ 9	7.9 ÷ 9.01	IP54	RS232
06030076	225 ÷ 250	224 ÷ 254	9 ÷ 10	8.9 ÷ 10.01	IP54	RS232
06030077	250 ÷ 275	250 ÷ 279	10 ÷ 11	9.9 ÷ 11.01	IP54	RS232
06030078	275 ÷ 300	275 ÷ 304	11 ÷ 12	10.9 ÷ 12.01	IP54	RS232

OPTIONAL ACCESSORIES:

01961000	Lithium battery, 3V, CR2032
00160201	TESA micrometer stand with clamp aperture 16 mm
072110123	ETALON micrometer stand with clamp aperture 20 mm
04761062	Opto-USB cable, duplex, bidirectional communication

MICROMASTER IP54 SET

Set consisting of 3 Micromaster external micrometers covering 0 ÷ 75 mm measuring range.

No		
06030029	Set of 3 MICROMASTER IP54 with RS232 output	0 ÷ 75



CONSISTING OF:

- 06030030 MICROMASTER RS IP54 digital micrometer, 0 ÷ 30 mm, 0,001 mm resolution, IP54 rating and RS232 output.
- 06030031 MICROMASTER RS IP54 digital micrometer, 25 ÷ 50 mm, 0,001 mm resolution, IP54 rating and RS232 output.
- 06030032 MICROMASTER RS IP54 digital micrometer, 50 ÷ 75 mm, 0,001 mm resolution, IP54 rating and RS232 output.
- 02119021 Etalon setting standard, 50 mm



TESAMASTER High Precision Micrometers with Digital Counter Reading to 0,1 mm

Analogue indication of full millimetres, hundredths and fractions of hundredths. Accurate, parallax-free reading on the vernier down to 0,001 mm.

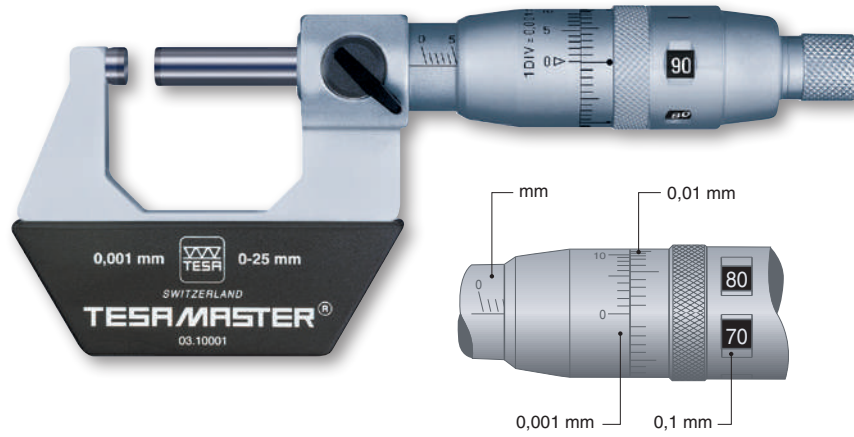

No	mm	μm	μm
00310001	0 ÷ 25	2	1
00310002	25 ÷ 50	2	1,5
00310003	50 ÷ 75	3	1,5
00310004	75 ÷ 100	3	1,5
00310005	100 ÷ 125	4	2
00310006	125 ÷ 150	4	2,5
00310007	150 ÷ 175	5	3
00310008	175 ÷ 200	5	3

- DIN 863 T1 NFE 11-095
- Scale division: 0,1 mm or 0,005 in
- Tungsten carbide
- Measuring range 0 to 100 mm with inspection report and declaration of conformity
- Measuring range > 100 mm with a declaration of conformity
- 0,5 mm
- Max. 10 N
- ≤ 100 mm: Ø 6,5 mm > 100 mm: Ø 8 mm
- Vernier reading to 0,001 mm or 0,0001 in

ETALON MICRORAPID 226 with 1 mm Revolution

High precision micrometers – Fast, accurate reading – No reading error of the millimetre fractions – Barrel with scale to 1 mm – Thimble with 100 graduations and vernier reading to 0,001 mm.

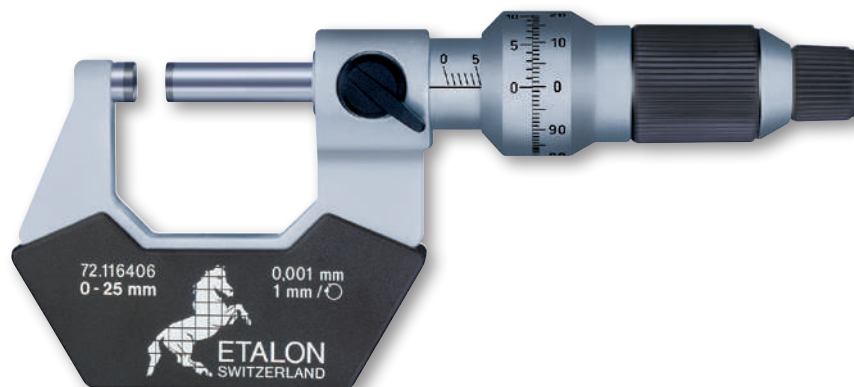

No	mm	μm	μm
072116406	0 ÷ 25	2	1
072116407	25 ÷ 50	2	1,5
072116408	50 ÷ 75	3	1,5
072116409	75 ÷ 100	3	1,5

- DIN 863 T1 NFE 11-095
- Tungsten carbide tipped
- Inspection report with a declaration of conformity
- 1 mm
- Max. 10 N
- Ø 6,5 mm
- Parallax-free vernier reading to 0,001 mm

- DIN 863 T1
NFE 11-095
- Tungsten carbide
tipped
- Measuring range
0 to 100 mm with
inspection report
and declaration of
conformity
- Measuring range
smaller than 100
mm with a declara-
tion of conformity
- 0.5 mm
- Max. 10 N
- ≤ 100 mm: Ø 6,5 mm
> 100 ≤ 300 mm:
Ø 8 mm

TESA ISOMASTER Standard Models with Analogue Indication

Slanted full millimetres on the barrel are set apart from the straight half millimetres to virtually eliminate reading errors.

The knurled sleeve needs only to be reversed to render the friction drive built into the thimble inactive.



No		
	mm	mm
00110101	0 ÷ 25	0,01
00110102	25 ÷ 50	0,01
00110103	50 ÷ 75	0,01
00110104	75 ÷ 100	0,01
00110105	100 ÷ 125	0,01
00110106	125 ÷ 150	0,01
00110107	150 ÷ 175	0,01
00110108	175 ÷ 200	0,01
00110109	200 ÷ 225	0,01
00110110	225 ÷ 250	0,01
00110111	250 ÷ 275	0,01
00110112	275 ÷ 300	0,01

Set of 4 TESA ISOMASTER Micrometers

The models covering application range 0 to 100 mm provide the quality that you need at competitive prices.



No		
		mm
00110113	Set of 4 ISOMASTER micrometers	0 ÷ 100
CONSISTING OF:		
00110101	ISOMASTER AA external micrometer with vernier scale, 0 ÷ 25 mm and resolution to 0,01 mm	
00110102	ISOMASTER AA external micrometer with vernier scale, 25 ÷ 50 mm and resolution to 0,01 mm	
00110103	ISOMASTER AA external micrometer with vernier scale, 50 ÷ 75 mm and resolution to 0,01 mm	
00110104	ISOMASTER AA external micrometer with vernier scale, 75 ÷ 100 mm and resolution to 0,01 mm	



MICRO-ETALON 225 - Precision Micrometers with a Dial Indicator

Feature a mobile anvil along with a built-in dial indicator. Ideal for comparative measurements on small part series. The nominal dimension is set on the micrometer while deviations are read on the dial indicator. Retractable anvil by means of a push-button. Rotating dial for fine adjustment, also with adjustable tolerance markers.

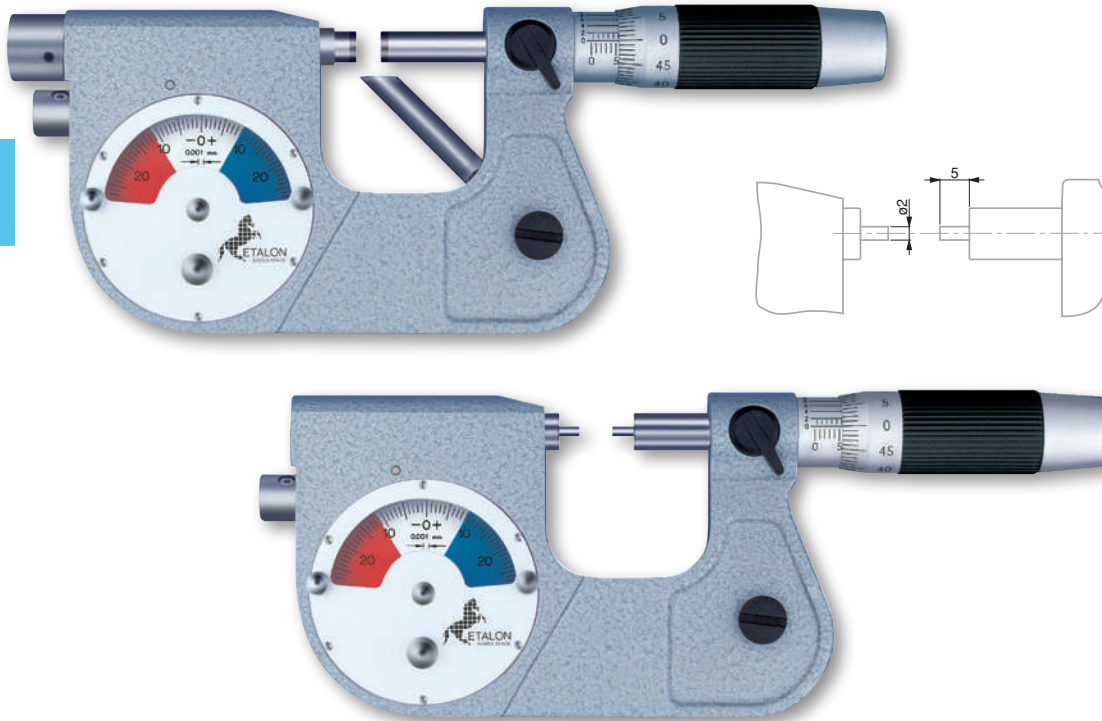

- DIN 863 T3 (Style D13)
- Micrometer: max. perm. error of 2 μm . Dial indicator: 1 μm .
- Dial indicator: repeatability limit of 0.5 μm
- Tungsten carbide tipped
- 0,5 mm
- Anvil: 4,5 to 5,5 N
- 6,5 mm dia. Model with small measuring faces: 2 mm dia., 5 mm long
- Micrometer with vernier reading to 0,002 mm. Dial indicator: 0,001 mm.
- Dial indicator: $\pm 0,025$ mm

072108669	0 ÷ 25	Standard inserts
072108691	25 ÷ 50	Standard inserts
072108722	0 ÷ 20	Pointed inserts
OPTIONAL ACCESSORY:		
072110978	Protective cover for dial indicator	

Protective Cover for Micro-Etalon 225

Made in transparent plastic – Can be mounted on the bezel – Protects the indicator against dust particles and liquids – Prevents both tolerance markers from being accidentally displaced.



072110978	Protective cover for dial indicator

- DIN 863 T3 (Style D14) NFE 11-090
- Meas. element: max. perm. error of 2 µm
- Mobile anvil: repeatability limit of 0,5 µm.
- Tungsten carbide tipped
- Adjustable part support (except model with small measuring faces).
- 0,5 mm
- Anvil: 2 up to 8 N, adjustable
- 6,5 mm or 2 mm dia. and length of 5 mm for models with small measuring faces.
- Vernier reading to 0,002 mm

ETALON MICROSEL 280

These micrometers have a mobile anvil along with an 8 mm diameter clamping bore for mounting a sensor with linear action such as a TESA GT 21/22 electronic probe. Specially designed for batch inspection of small precision made parts.

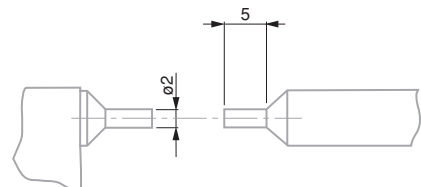
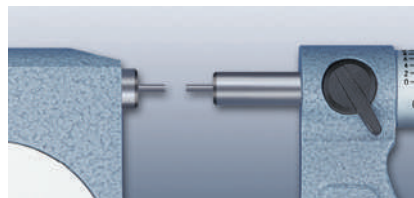

		mm	
072110816	0 ÷ 25	Standard inserts	
072110853	0 ÷ 20	Pointed inserts	

Electronic probe and micrometer stand are not part of the delivery scope and must be ordered separately.



MICROMASTER Micrometer with Small Measuring Faces

For measuring grooves, feather grooves, splines and other difficult to reach locations – Small measuring faces specially made to check small precision workpieces.



No		
	mm	in
06030034	0 ÷ 30	0 ÷ 1.2
OPTIONAL ACCESSORY:		
01961000	Lithium battery 3V, CR2032	

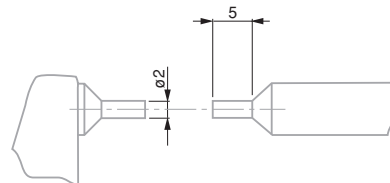

- DIN 863 T3 (Style D3)
- 0,001 mm / 0.00005 in
- Conversion mm/in
- Fixed measuring faces: tungsten carbide.
- Degree of protection (IEC 60529): IP54 or IP40 with use of the digital output
- Measuring range 0 to 100: with a SCS calibration certificate.
- RS232 interface, opto-coupled.
- For additional technical data: see standard.
- Max. 10 N

TESAMASTER AD Micrometer with Small Measuring Faces



No	
	mm
00311301	0 ÷ 25

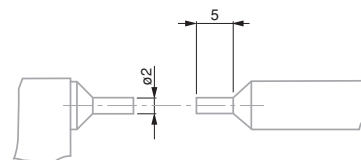

- DIN 863 T3 (Style D3) NFE 11-090
- Scale division 0,1 mm
- Fixed measuring faces: tungsten carbide
- Inspection report with a declaration of conformity
- Max. 10 N
- Vernier reading to 0,001 mm

- DIN 863 T3 (Style D3) NFE 11-090
- Fixed measuring faces: tungsten carbide
- Inspection report with a declaration of conformity
- Max. 10 N
- 0,01 mm

ISOMASTER AD Micrometer with Small Measuring Faces

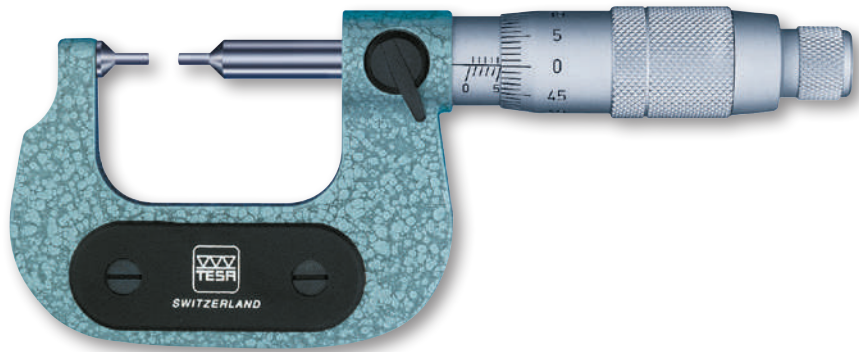

00210101	0 ÷ 25 mm

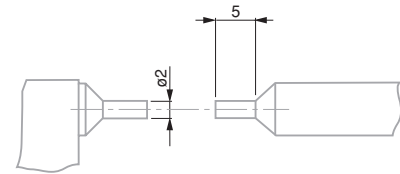

- Steel ball tip, hardened and lapped. Dull-chrome brass retainer

Spherical Element for External Micrometers

Holder with a ball tip to fit measuring faces $\varnothing 6,5$ mm – Used to measure tubing wall thickness or components with concave surfaces etc.

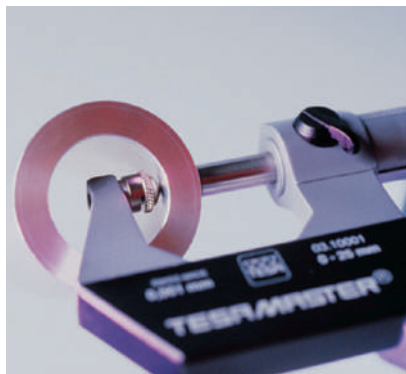

072103522	5 mm



MICROMASTER Micrometer with Two Spherical Measuring Faces

Rounded measuring faces on both anvil and spindle for measuring concave surfaces on components, e.g. ball-bearing guides or wall thickness.



06030081	0 ÷ 25	0 ÷ 1

- DIN 863 T3 (Style D1)
- 0,001 mm / 0.00005 in
- Tungsten carbide
- Inspection report with a declaration of conformity
- RS232
- Additional technical data: see standard.
- Max. 10 N
- Spherical: 3,5 mm radius.

MICROMASTER Micrometer with One Spherical Measuring Face

For the measurement of wall thickness of tubing and other similar tasks.



06030079	0 ÷ 30	0 ÷ 1.2

- DIN 863 T3 (Style D1)
- 0,001 mm or 0.00005 in
- Anvil in tungsten carbide, Micrometric spindle in tungsten carbide
- Inspection report with a declaration of conformity
- RS232
- Other technical data see standard.
- Max. 10 N
- Anvil with a 3,5 mm spherical face (MICROMASTER) or 3,25 mm (ETALON). Spindle with a flat measuring face.

- DIN 863 T3 (Style D1) NFE 11-090
- Titanium carbide coated for model No. 00112106. Hardened steel for other models.
- Inspection report with a declaration of conformity
- 0,5 mm
- Max. 10 N
- Radius of spherical faces: to 3,25 mm
- 0,01 mm

ISOMASTER AAS Micrometer with Two Spherical Measuring Faces

Rounded measuring faces for checking concave surfaces such as ball-bearing guides and wall thickness.



	mm
00110901	0 ÷ 25

- DIN 863 T3 (Style D 10) N
- 0,001 mm / 0,00005 in
- Conversion mm/in
- Tungsten carbide
- Inspection report with a declaration of conformity
- RS232
- Additional technical data: see standard.
- 0,75 mm for 3-flute test pieces or 0,559 mm for 5-flute test pieces.
- Max. 10 N
- Angle of the prism aperture: 60° for 3-flute test pieces or 108° for 5-flute test pieces.

MICROMASTER Micrometers with Prismatic Measuring Faces

Measure test pieces with an odd number of grooves such as milling cutters, taps, drills and spline shafts as well as polygons. Determine roundness errors on cylindrical surfaces. The angle of the prism aperture is designed for workpieces having 3 or 5 flutes.



	mm	in	
06030087	1 ÷ 7	0.04 ÷ 0.27	3 flute test pieces (60°)
06030088	5 ÷ 20	0.20 ÷ 0.80	3 flute test pieces (60°)
06030089	20 ÷ 35	0.80 ÷ 1.38	3 flute test pieces (60°)
06030090	35 ÷ 50	1.38 ÷ 1.97	3 flute test pieces (60°)
06030091	50 ÷ 65	1.97 ÷ 2.56	3 flute test pieces (60°)
06030092	65 ÷ 80	2.56 ÷ 3.15	3 flute test pieces (60°)
06030093	1 ÷ 7	0.04 ÷ 0.27	5 flute test pieces (108°)
06030094	5 ÷ 25	0.20 ÷ 0.98	5 flute test pieces (108°)
06030095	25 ÷ 45	0.98 ÷ 1.77	5 flute test pieces (108°)
06030096	45 ÷ 65	1.77 ÷ 2.56	5 flute test pieces (108°)
06030097	65 ÷ 85	2.56 ÷ 3.35	5 flute test pieces (108°)



ISOMASTER AS Micrometers with Prismatic Measuring Faces

The micrometer ISOMASTER AS is used for measuring test pieces with an odd number of grooves such as milling cutters, taps, drills and spline shafts as well as polygons. It can also determine roundness errors on cylindrical workpieces.

The aperture angle of the prism is designed for workpieces having 3 or 5 flutes or their multiples.

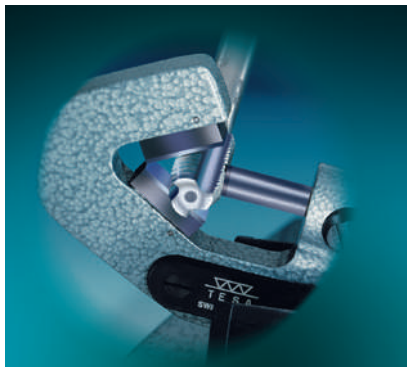

No		
	mm	
00410001	1 ÷ 7	3 flute test pieces (60°)
00410002	5 ÷ 20	3 flute test pieces (60°)
00410003	20 ÷ 35	3 flute test pieces (60°)
00410004	35 ÷ 50	3 flute test pieces (60°)
00410005	50 ÷ 65	3 flute test pieces (60°)
00410102	5 ÷ 25	5 flute test pieces (108°)

- DIN 863 T3 (Style D 10) NFE 11-090
- Tungsten carbide tipped
- 0,75 mm for 3-flute test pieces or 0,559 mm for 5-flute test pieces
- Max. 10 N
- Angle of the prism aperture: 60° for 3-flute test pieces or 108° for 5-flute test pieces.
- 0,01 mm

Cylindrical Setting Standards for Micrometers

No			
	μm	μm	
00440001	0,5	–	5
00440002	0,7	1	20
00440003	0,7	1	25
00440004	1	1	35
00440005	1,2	1,5	45
00440006	1,2	1,5	50
00440007	1,5	1,5	65



- Alloyed steel, hardened
- With a protective cap from the nominal size of 20 mm. Effective diameter engraved on the front face.

- DIN 863 T3 (Style D7)
- 0,001 mm / 0.00005 in
- Conversion mm/in
- Hardened steel
- Suitable from module 0,5 onwards
- Inspection report with a declaration of conformity
- RS232
- Additional technical data: see standard.
- Max. 10 N
- Non-rotating spindle
≤ 85 mm: 25 mm dia.
> 85 ≤ 115 mm: 30 mm dia.

MICROMASTER Micrometers for Gear Pitch Measurement

Flanges with ring-shaped measuring faces for root tangent lengths, W_k on gear pitches, distance between grooves and slots as well as other hard-to-reach locations.

Non-rotating measuring spindle, without spindle lock.

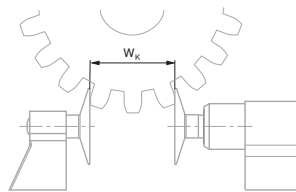

No	mm	in
06030041	0 ÷ 30	0 ÷ 1.2
06030042	25 ÷ 55	1 ÷ 2.1
06030043	55 ÷ 85	2.1 ÷ 3.35
06030044	85 ÷ 115	3.35 ÷ 4.5

- DIN 863 T3 (Style D7) NFE 11-090
- Hardened steel
- Suitable from module 0,6
- Inspection report with a declaration of conformity
- Max. 10 N
- ≤ 100 mm: 25 mm dia.
> 100 ≤ 150 mm: 32 mm dia.
- 0,01 mm

ISOMASTER AE Micrometers for Gear Tooth / Pitch Measurement

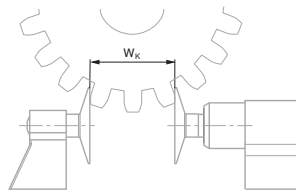
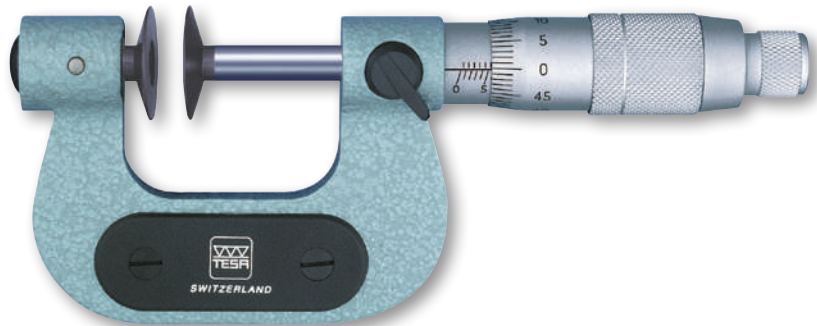

No	mm
00210201	0 ÷ 25
00210202	25 ÷ 50
00210203	50 ÷ 75
00210204	75 ÷ 100

mm	µm	µm	µm	µm	µm	µm
0 ÷ 30	10	4	2	5	2	2
25 ÷ 55	10	4	2	5	2	2
55 ÷ 85	11	5	2	5	3	3
85 ÷ 115	12	5	2	6	4	4



MICROMASTER with 7 Pairs of Interchangeable Measuring Inserts

Non-rotating spindle, without spindle lock.



- 0,001 mm / 0,00005 in
- Conversion mm/in
- Micrometer element with a max. perm. error of 4 µm
- Hardened steel
- 7,5 mm diameter non-rotating spindle. With a fixing bore for a measuring insert. Adjustable attachment on the anvil for a measuring insert, with lock.
- Inspection report with a declaration of conformity
- RS232
- Additional technical data: see standard
- Max. 10 N

No	mm	in
06030045	0 ÷ 30	0 ÷ 1.2
CONSISTING OF:		
06030099	MICROMASTER single micrometer for use with interchangeable measuring inserts, 0-30 mm	
00269027	Full set of 7 pairs of inserts	

Full Set of Measuring Inserts for MICROMASTER with Interchangeable Inserts

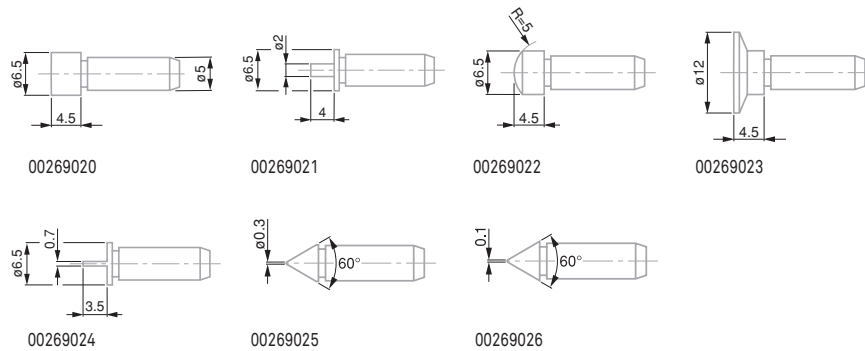

No	≡
00269027	Full set of 7 pairs of inserts
COMPOSITION OF THE SETS:	
00269020	Pair of flat inserts
00269021	Pair of spline inserts
00269022	Pair of spherical inserts
00269023	Pair of disc inserts
00269024	Pair of blade inserts
00269025	Pair of point inserts
00269026	Pair of knife edge inserts

N DIN 863 T3
(Style D18)

000 0,001 mm /
0.00005 in

mm/in Conversion
mm/in

Report Inspection report
with a declaration
of conformity

RS232

Warning Additional
technical data:
see appropriate
standard

Hand Max. 10 N

30mm 30 mm measuring
span

MICROMASTER AC Micrometers for Thread Measurement

Used for pitch diameter inspection. Anvil with adjustable holder for mounting a measuring insert with prismatic faces. Fine screw adjustment and locking device. The spindle has a fixing bore for a cone-shaped measuring insert.



No	mm	in
06030062	0 ÷ 25	0 ÷ 1
06030063	25 ÷ 50	1 ÷ 2
06030064	50 ÷ 75	2 ÷ 3
06030065	75 ÷ 100	3 ÷ 4

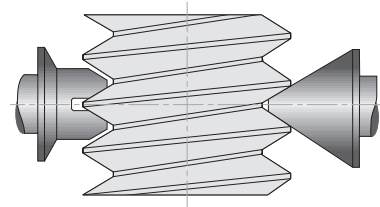

Note: Measuring inserts and setting standards must be ordered separately.

N DIN 863 T3
(Style D 18)
NFE 11-090

0,5mm

Hand Max. 10 N

0,01mm

ISOMASTER AC Micrometers for Thread Measurement Models

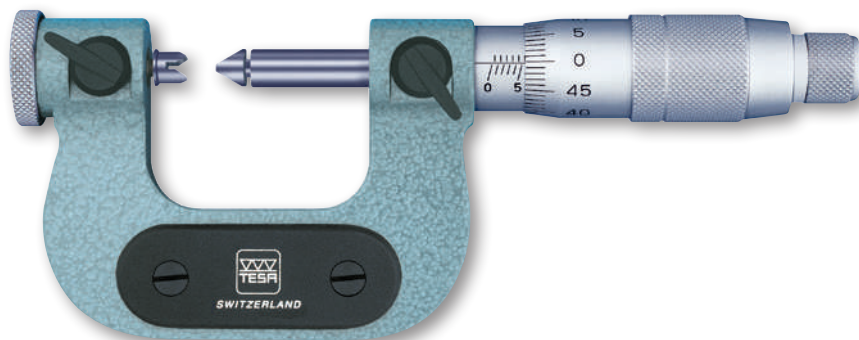

No	mm
00210001	0 ÷ 25
00210002	25 ÷ 50
00210003	50 ÷ 75
00210004	75 ÷ 100

Measuring inserts and setting standards must be ordered separately.



Interchangeable Thread Inserts for TESA Micrometers Series AC

With measuring faces specially designed for checking pitch diameters.

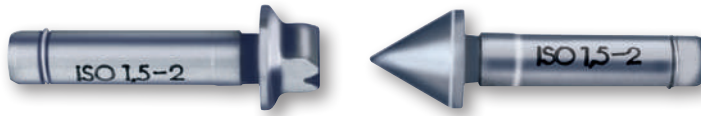

- Hardened steel
- Supplied in sets or pairs
- Fixing rod: 3,5 mm dia., 15,5 mm long

For unified inch threads, UN, UNC, UNF... 60° flank angle

For Whitworth threads, 55° flank angle

For ISO metric threads, flank angle 60°

No	=
00250015	Set of inserts 64 ÷ 2.5 in
<i>COMPOSITION OF THE SETS:</i>	
00250000	AC UN,UNC,UNF 64 ÷ 42 in
00250001	AC UN,UNC,UNF 42 ÷ 25 in
00250002	AC UN,UNC,UNF 25 ÷ 17 in
00250003	AC UN,UNC,UNF 17 ÷ 10 in
00250004	AC UN,UNC,UNF 10 ÷ 6.5 in
00250005	AC UN,UNC,UNF 6.5 ÷ 4 in
00250006	AC UN,UNC,UNF 4 ÷ 2.5 in

No	=
00250115	Set of inserts, whitworth 60 ÷ 3 in
<i>COMPOSITION OF THE SETS:</i>	
00250100	AC whitworth 60 ÷ 48 in
00250101	AC whitworth 48 ÷ 40 in
00250102	AC whitworth 40 ÷ 32 in
00250103	AC whitworth 32 ÷ 24 in
00250104	AC whitworth 24 ÷ 18 in
00250105	AC whitworth 18 ÷ 14 in
00250106	AC whitworth 14 ÷ 10 in
00250107	AC whitworth 10 ÷ 7 in
00250108	AC whitworth 7 ÷ 4.5 in
00250109	AC whitworth 4.5 ÷ 3 in

No	=
00240015	Set of inserts ISO 0.40 ÷ 6.00
<i>COMPOSITION OF THE SETS:</i>	
00240000	ISO 0.4 ÷ 0.50
00240001	ISO 0.5 ÷ 0.60
00240002	ISO 0.6 ÷ 0.80
00240003	ISO 0.8 ÷ 1.00
00240004	ISO 1.0 ÷ .25
00240005	ISO 1.25 ÷ 1,50
00240006	ISO 1,5 ÷ 2,00
00240007	ISO 2,00 ÷ 2,50
00240008	ISO 2,5 ÷ 3,00
00240009	ISO 3,00 ÷ 4,00
00240010	ISO 4,00 ÷ 5,00
00240011	ISO 5,0 ÷ 6,00

Setting Standards for Screw Thread Micrometers - Metric, 60° or 55° flank angle



- Hardened steel
- Insulating sleeve marked with actual size

60° flank angle, metric

60° flank angle, imperial

55° flank angle, metric

No	A	T	Flank angle	mm
00240501	60°	25		
00240502	60°	50		
00240503	60°	75		
00240504	60°	100		
00240505	60°	125		

No	A	T	Flank angle	in
00250501	60°	1		
00250502	60°	2		
00250503	60°	3		
00250504	60°	4		
00250505	60°	5		

No	A	T	Flank angle	mm
00240601	55°	25		
00240602	55°	50		
00240603	55°	75		

 Steel wires, hardened



 Single pairs are supplied in a plastic box, full set in a wooden case

 Wires are mounted on holders: 2-wire holder rests on anvil while the single wire holder is used on spindle side

XB Wires for Screw Threads

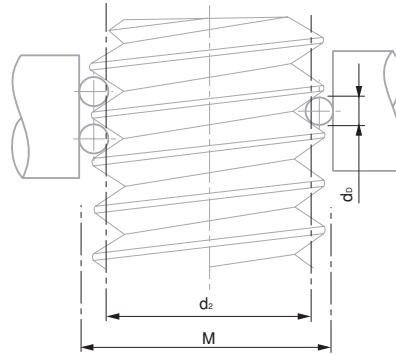
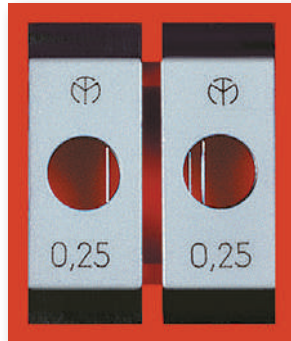
For measuring pitch diameter of threads using the three-wire method. Actual flank diameter d_2 can either be determined arithmetically or with the aid of the relevant tables based on the measured actual size M – Suitable for all standard micrometers with measuring faces of 6,5 mm diameter.



No	\varnothing Diameter of the wires dD in mm	 ISO metric threads Pitch in mm	 Whitworth threads Number of threads per in	 Unified inch-threads UN, UNC, UNF Number of threads per in
00240701	0,17	0,25 / 0,3	–	–
00240702	0,22	0,35	–	72
00240703	0,25	0,4	60	64
00240704	0,29	0,45 / 0,5	–	56
00240705	0,335	0,6	48 / 40	48 / 44
00240706	0,455	0,7 ÷ 0,8	–	32
00240707	0,53	0,9	32 / 28	28
00240708	0,62	1,0	26 / 24	24
00240709	0,725	1,25	22 ÷ 19	20
00240710	0,895	1,5	18 / 16	18 / 16
00240711	1,10	1,75	14	14 / 13
00240712	1,35	2,0	12 / 11	12 / 11
00240713	1,65	2,5	10 / 9	10 / 9
00240714	2,05	3,0 / 3,5	8 / 7	8 / 7
00240715	2,55	4,0 / 4,5	6	6
00240716	3,20	5,0 / 5,5	5 / 4,5	5 / 4,5

 Wires in hardened steel

 Single pairs supplied in a plastic case, full set in a wooden box.

 Wires mounted on holders: the 2 wire holder rests on the anvil, whilst the single wire holder is used on the spindle side.

Set of 16 Pairs of XB Wires for Thread Measurement

No	\varnothing Diameter of the wires dD in mm
00240700	0,17 ÷ 3,20

MICROMASTER with Interchangeable Anvils

All sets include 4 interchangeable anvils with increasing length in steps of 25 mm. The anvils are adjusted (and numbered) in sets, thus rendering the correction of the indication unnecessary whenever an anvil is exchanged.

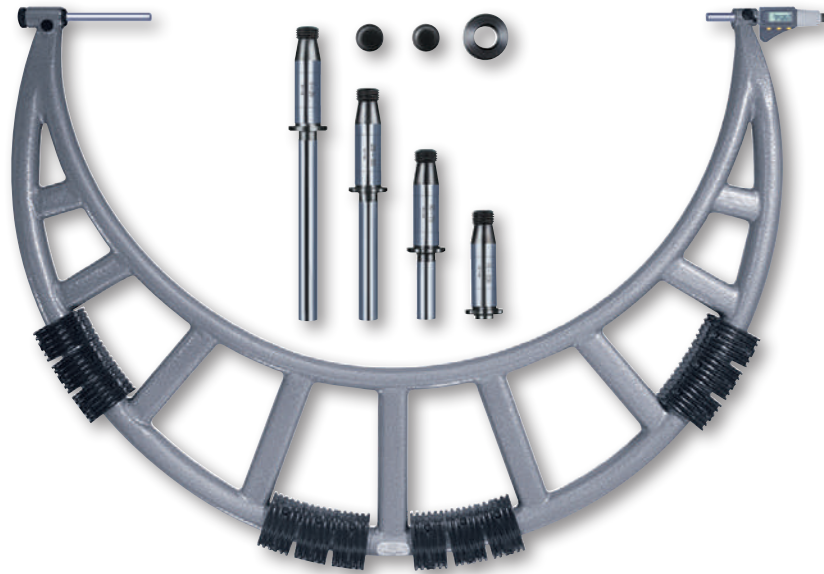

No	mm	in	µm	µm
06030047	0 ÷ 100	0 ÷ 3.94	6	3
06030048	100 ÷ 200	3.94 ÷ 7.87	7	4,5
06030049	200 ÷ 300	7.87 ÷ 11.81	8	7
06030050	300 ÷ 400	11.81 ÷ 15.75	9	9
06030051	400 ÷ 500	15.75 ÷ 19.69	10	9

OPTIONAL ACCESSORIES:

00140301	Dial gauge element
----------	--------------------



Dial Gauge Element for MICROMASTER and AB Micrometers

Can replace the interchangeable anvils on AB series micrometers. Makes finding the culmination point easier. Ensures a constant measuring force.

No	
00140301	Dial gauge element

- DIN 863 T3 (Style D16)
- 0,001 mm / 0.00005 in
- LCD, digit height: 7 mm
- Conversion mm/in
- Tungsten carbide tipped
- Inspection report with declaration of conformity
- RS232
- Additional technical data: see standard
- 0,5 mm
- Max. 10 N
- Ø 8 mm
- 30 mm measuring span
- 0 ≤ 500 mm: malleable cast iron.
> 500 ≤ 1000 mm: steel tube with insulating grips. Maximum flexing of the frame under a measuring force of 10 N: see table
- Element body: Ø 11 mm, length 100 mm. Dial gauge 01410211: dial Ø 40 mm, two directional reading.
- With dial gauge and clamp
- Max. 10 N
- Ø 8 mm
- 0,01 mm
- ± 1,5 mm

- DIN 863 T3 (Style D16) NFE 11-090
- Tungsten carbide tipped
- 0,5 mm
- Max. 10 N
- 8 mm diameter
- 0,01 mm
- 0 ≤ 500 mm: malleable cast iron; 500 ≤ 1000 mm: steel tube with insulating grips. Max. flexure of the frame under a measuring force of 10 N: see the table opposite

ISOMASTER AB with Interchangeable Anvils

Lightweight, but rugged anvil micrometers. Set No. 00140101 includes 4 interchangeable anvils with increasing length in steps of 25 mm.

Anvils are adjusted and numbered in pairs, thus rendering any correction of the indication unnecessary whenever an anvil is exchanged.

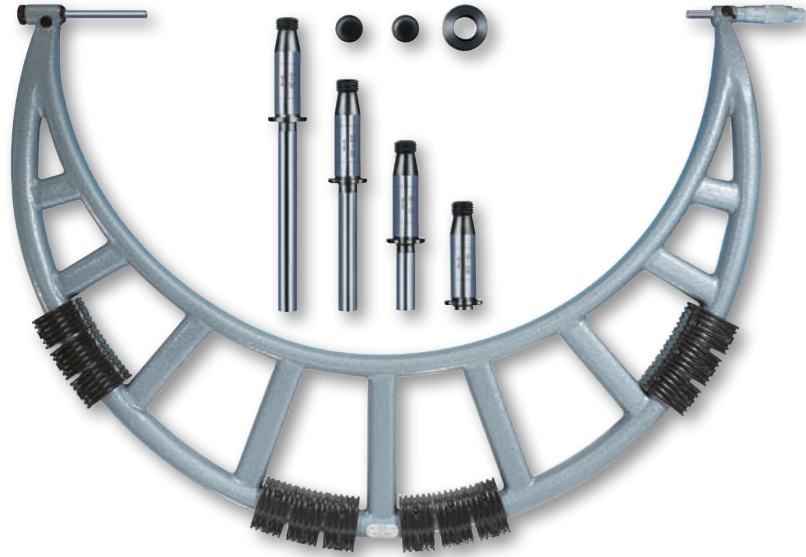

No			
	mm	μm	μm
00111901	0 ÷ 100	6	3
00111902	100 ÷ 200	7	4,5
00111903	200 ÷ 300	8	7
00111904	300 ÷ 400	9	9
00111905	400 ÷ 500	10	9
OPTIONAL ACCESSORIES:			
00140301	Dial gauge element		

Measuring range up to 1500 mm also available upon request.

- DIN 863 T3 (Style D16) NFE 11-090
- Tungsten carbide tipped
- Set includes 2 guard plates for the frame as well as 1 clamping nut
- 8 mm diameter

Interchangeable Anvils for ISOMASTER AB Series

Set of 4 interchangeable anvils with increasing length in steps of 25 mm. The anvils are adjusted and numbered in pairs, thus eliminating the need for resetting the indication when exchanging either of them. Supplied as standard accessories with the AB series micrometers.



No	
00140101	Interchangeable anvils AB



INTERAPID Setting Standards

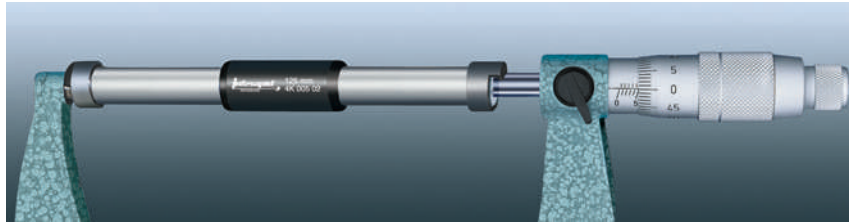

No	mm
02140001	25
02140002	50
02140003	75
02140004	100
02140005	125
02140006	150
02140007	175
02140008	200
02140009	225
02140010	250

No	mm
02140011	275
02140012	300
02140013	325
02140014	350
02140015	375
02140016	400
02140017	425
02140018	450
02140019	475
02140020	500

Measuring range up to 1500 mm also available upon request.

ETALON Cylindrical Step Gauges

For adjustment of the display and calibration.



No	mm
072112020	5 ÷ 100
072112021	5 ÷ 150

Guide Collars for Setting Standards

Making the positioning of INTERAPID setting standards quick and easy.



No	mm	mm
02140103	100 ÷ 175	8
02140108	200 ÷ 1475	8

- Maximum permissible error over the length: $\pm (1 + L/100) \mu\text{m}$, L in mm
- Hardened steel
- Inspection report with actual measured length
- Cylindrical gauge block with plastic insulating grip and dull chrome shaft
- Two measuring faces, flat and rounded
- With lengths:
 $\leq 175 \text{ mm} = 10 \text{ mm}$,
 $\geq 200 \text{ mm} = 13 \text{ mm}$.

- Maximum permissible errors for nominal diameters:
 $\leq 80 \text{ mm} = 1,5 \mu\text{m}$,
 $\geq 90 \leq 120 \text{ mm} = 2,0 \mu\text{m}$,
 $\geq 130 \text{ mm} = 2,5 \mu\text{m}$
- Alloyed steel, hardened
- Diameters in steps of 5 mm ($\leq 50 \text{ mm}$) or 10 mm ($> 50 \text{ mm}$).

Micrometer Stands

For external micrometers up to 300 mm as well as many other hand-held tools.



No

=

00160201	TESA micrometer stand with clamp aperture 16 mm
072110123	ETALON micrometer stand with clamp aperture 20 mm

 Length tolerance with reference to the nominal dimension: $\pm 100 \mu\text{m}$

 Each set is supplied in a wooden case

 Flatness tolerances for optical parallels with lengths:
 $\leq 27,335 \text{ mm}$
 $= 0,15 \mu\text{m}$ $\geq 52,00 \div 77,335 \text{ mm} = 0,2 \mu\text{m}$

 Tolerances in parallelism for optical parallels with lengths:
 $\leq 27,335 \text{ mm}: 0,4 \mu\text{m}$
 $\geq 52,00 \div 77,335 \text{ mm}: 0,5 \mu\text{m}$

 $\varnothing 31 \text{ mm}$

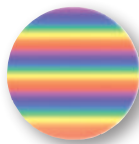

Optical Flats with Two Parallel Faces

Used for examining the flatness and parallelism of the measuring faces on external micrometers as well as other similar measuring instruments. The difference in length of the optical flats within a set matches a quarter or a third of the spindle pitch of 0,5 mm.

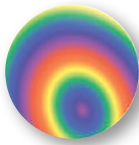

No

=



mm

02510000	Set interference glass 12 \div 12,375 mm	12,00 \div 12,375
02510001	Interference glass 12	12,00
02510002	Interference glass 12,125	12,125
02510003	Interference glass 12,25 mm	12,25
02510004	Interference glass 12,375 mm	12,375
02510100	Set interference glass 27 \div 27,335 mm	27,00 \div 27,335
02510101	Interference glass 27 mm	27,00
02510102	Interference glass 27,165 mm	27,165
02510103	Interference glass 27,335 mm	27,335
02510200	Set interference glass 52 - 52,3	52,00 \div 52,335
02510201	Interference glass 52 mm	52,00
02510202	Interference glass 52,165 mm	52,165
02510203	Interference glass 52,335 mm	52,335
02510300	Set interference glass 77 \div 77,335 mm	77,00 \div 77,335
02510301	Interference glass 77,00 mm	77,00
02510302	Interference glass 77,165 mm	77,165
02510303	Interference glass 77,335 mm	77,335



MICROMASTER Depth Micrometers

Non-rotating measuring rod. Sets with a step length of 30 mm.



No	mm	in	mm
06030069	0 ÷ 90	0 ÷ 3.5	50 x 15
06030070	0 ÷ 180	0 ÷ 7	100 x 15

Set of Depth Rods for Micromaster

Set of 6 depth rods.



No	mm
06060021	0 ÷ 180

ISOMASTER AQ Depth Micrometers

Measuring rods with a step length of 25 mm.

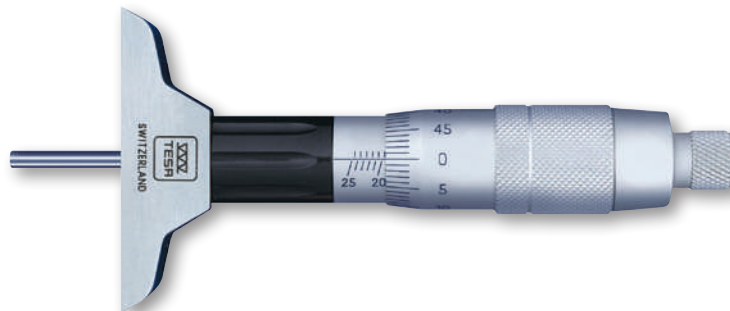

No	mm	mm
00211002	0 ÷ 75	50 x 15
00211003	0 ÷ 150	50 x 15
00211004	0 ÷ 75	100 x 15
00211005	0 ÷ 150	100 x 15

- DIN 863 T2 (Style T)
- 0,001 mm / 0.00005 in
- Conversion mm/in
- Max. perm. error (meas. element): 3 µm
- Measuring rods with hardened steel tips
- Non-rotating spindle
- Inspection report with a declaration of conformity
- RS232 data output
- 0,5 mm
- 3 mm diameter measuring rods
- 30 mm

- DIN 863 T2 (Style T) NFE 11-097
- Max. perm. error of the measuring element: 3 µm
- Measuring rods with hardened steel ends
- 0,5 mm
- 3 mm diameter measuring rods. Measuring face on the base: see table
- 0,01 mm

N DIN 863 T2 (Style E)

000 0,001 mm / 0.00005 in

mm/in Conversion mm/in

0.4 Max. perm. error of 4 µm

T Tungsten carbide tipped

IR Inspection report with a declaration of conformity

RS RS232 interface, opto-coupled

AT Additional technical data: see standard

0.5 0,5 mm

10N Max. 10 N

6.5 6,5 mm dia.

N DIN 863 T2 (Style E)

000 Value of the scale: 0,1 mm

0.2 Max. perm. error of 2 µm

T Tungsten carbide tipped

0.5 0,5 mm

10N Max. 10 N

6.5 6,5 mm dia

V Vernier reading to 0,001 mm

MICROMETER HEADS

Micrometer heads used principally for the measurement of displacement on special fixtures such as roller tables, XY tables. Mounted using the cylindrical coupling shaft.

MICROMASTER Micrometer Heads

Without spindle lock



No		
	mm	
06030038	0 ÷ 30	12h6
06030039	30 ÷ 0	12h6
06030040	30 ÷ 0	12h6

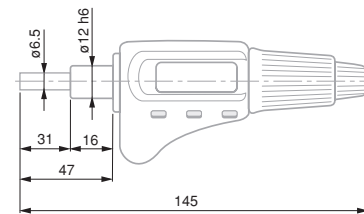

TESAMASTER AR Micrometer Heads

Without spindle lock.



No		
	mm	
00312301	0 ÷ 25	12h6

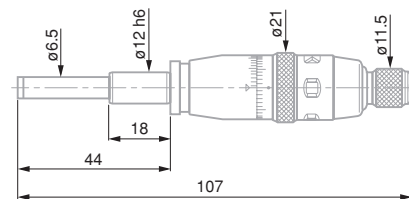

ETALON 266 Micrometer Heads

With spindle lock.

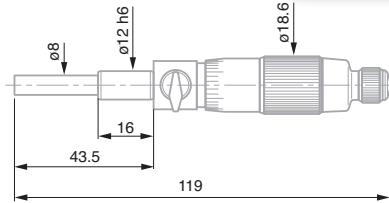

DIN 863 T2 (Style E) NFE 11-090

Max. perm. error: 3 μm

Tungsten carbide tipped

0,5 mm

Vernier reading to 0,002 mm



072115943

0 ÷ 25

Ø 8

12h6

Spindle lock



ISOMASTER AR Micrometer Heads

Without spindle lock.

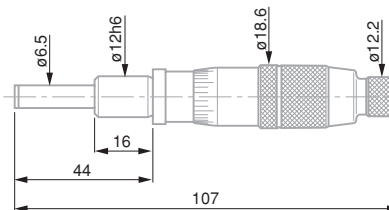

DIN 863 T2 (Style E) NFE 11-090

Max. perm. error of 3 μm

Tungsten carbide tipped

0,5 mm

Max. 10 N

6,5 mm dia

0,01 mm



00211201

0 ÷ 25

12h6

- ISO 13385-1
- Stainless steel, hardened
- Inspection report with a declaration of conformity
- Technical data: see appropriate standard
- Tungsten carbide tipped

TESA DUO-SET 1



No **=**

00530020 TESA DUO-SET 1

CONSISTING OF:

No **=**



mm

00510008 CCMA-M dial caliper with measuring range of 150 mm, resolution to 0,02 mm and 2 mm travel per revolution.

0 ÷ 150

00560013 Depth foot for calipers up to 150 mm

00110101 ISOMASTER AA external micrometer with vernier scale, 0 ÷ 25 mm and resolution to 0,01 mm

0 ÷ 25

00560031 Case for set of instruments

- DIN 862
- Stainless steel, hardened
- Inspection report with a declaration of conformity
- Technical data: according to the appropriate standard
- Tungsten carbide tipped

TESA DUO-SET 2



No **=**

00530021 TESA DUO-SET 2

CONSISTING OF:

No **=**



mm

00510008 CCMA-M dial caliper with measuring range of 150 mm, resolution to 0,02 mm and 2 mm travel per revolution.

0 ÷ 150

00560013 Depth foot for calipers up to 150 mm

00310001 TESAMASTER external micrometer with measuring range 0 ÷ 25 mm and vernier scale reading to resolution 0,001 mm.

0 ÷ 25

00560031 Case for set of instruments



TESA DUO-SET 13



- ISO 13385-1
- Stainless steel, hardened.
- SCS calibration certificate
- Technical data: see appropriate standard
- Tungsten carbide tipped

No	=		
00531004		TESA DUO-SET 13	
CONSISTING OF:			
No	=		
00530319		TWIN-CAL electronic caliper with measuring range 150 mm, resolution 0,01 mm, IP67 rating and square depth rod.	150
00560013		Depth foot for calipers up to 150 mm	
06030020		MICROMASTER IP54 digital micrometer, 0 ÷ 30 mm, 0,001 mm resolution, IP54 rating.	0 ÷ 30
00560090		Case for set of instruments	

TESA DUO-SET 16



- DIN 862
- Stainless steel, hardened
- SCS calibration certificate
- Technical data: see appropriate standard
- Tungsten carbide tipped

No	=		
00531007		TESA DUO-SET 16	
CONSISTING OF:			
No	=		
00530094		Standard TWIN-CAL, electronic caliper, with measuring range 150 mm, resolution of 0,01 mm and IP40 protection rating. Round depth rod.	150
00560013		Depth foot for calipers up to 150 mm	
06030010		MICROMASTER EASY digital micrometer, 0 ÷ 30 mm, 0,001 mm resolution.	0 ÷ 30
00560090		Case for set of instruments	

Internal Measurement

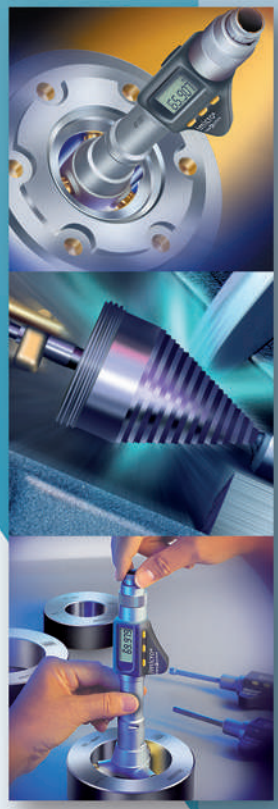

THE CHALLENGES OF INTERNAL MEASUREMENT

Bore measurement is more difficult than external measurement of components. Apart from the very tight tolerances specified, all measuring elements having a direct influence on the uncertainty of measurement must be designed in such a way that they can fit into the bore to be checked.

3-LINE CONTACT OFFERS A TRUE ADVANTAGE

The near perfect auto-centering and auto alignment provided by TESA IMICRO, TESA TRI-O-BOR, ALESOMETER and ETALON INTALOMETER make bore measurement reliable, without the need for an operator to estimate.

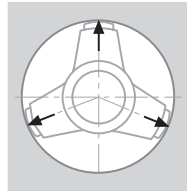

The three measuring bolts are spaced 120° apart, thus providing optimum self-centring.

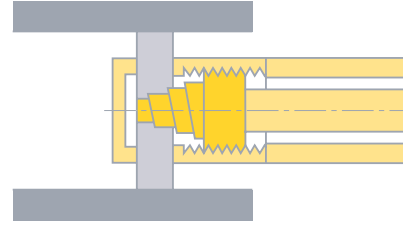

The measuring bolts with 3-line contact allows the micro-meter to align itself parallel to the contact surfaces.

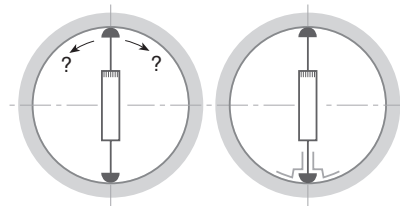

2-point contact measuring instruments are not self-centring. To enable bore measurements, the use of auxiliary means are required.

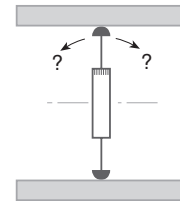

2-point contact does not permit the tool to align itself in relation to the bore axis.

A SINGLE TOOL CAN REPLACE HUNDREDS OF PLUG GAUGES

Unlike plug gauges that check only one toleranced size, a single tool can measure many diameters. Depending on the model that is being used, through holes and blind bores along with short centring shoulders can be inspected reliably.



ESTABLISHING FORM ERRORS

Form errors are established through measurements taken at several points within a bore. Micrometers with 3-line contact determine run-out errors in a triangular way. Micrometers with 2-point contact measure medium-size diameters only. They do not allow users to see what makes diameters measured at various points different.

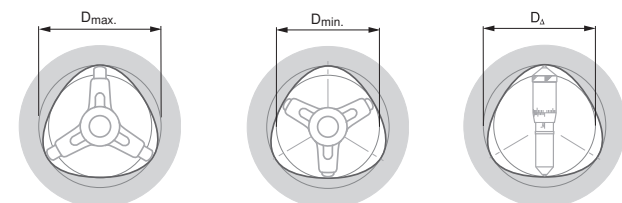
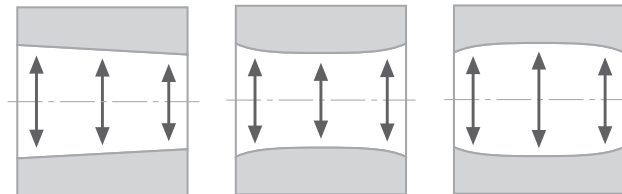

N DIN 863 T4
(Style C1)
NFE 11-099

Measuring faces for application ranges from 3,5 to 12 mm:
hardened steel (HV30 770)
11 to 100 mm: TiN hard-coating (HV5 2300)
100 to 300 mm: carbide tipped (HV5 1300)

Inspection report with a declaration of conformity

TESA IMICRO with Analogue Indication – Metric

Self-centring and self-aligning internal micrometers. The high-precision thread machined into the measuring cone, combined with the measuring bolts specially arranged to provide 3-line contact, make them the only micrometers in the world that respect the ABBE principle. Measure depth, reliably.

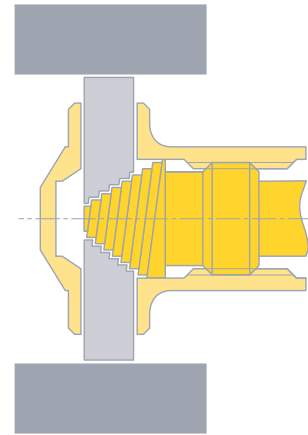
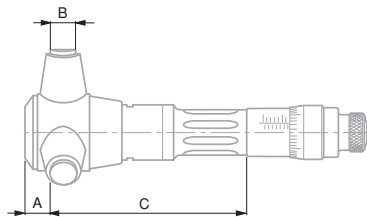
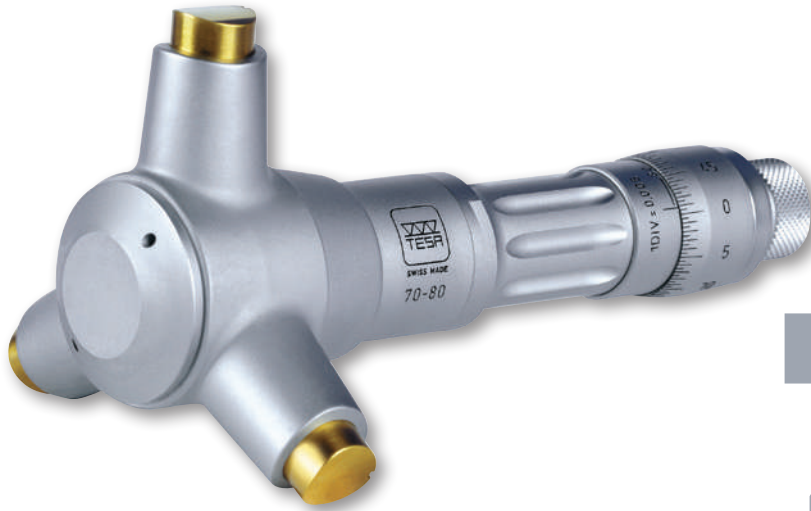



No							
	mm	mm	µm	µm	A mm	B mm	C mm
00813410	3,5 ÷ 4	0,001	4	4	2	1,5	20
00813411	4 ÷ 4,5	0,001	4	4	2	1,5	20
00813412	4,5 ÷ 5,5	0,001	4	4	2	1,5	25
00813413	5,5 ÷ 6,5	0,001	4	4	2	1,5	25
00810001	6 ÷ 8	0,001	4	4	2,5	2,5	52
00810002	8 ÷ 10	0,001	4	4	2,5	2,5	52
00810003	10 ÷ 12	0,001	4	4	2,5	2,5	52
00810801	11 ÷ 14	0,005	4	4	3,5	4	77
00810802	14 ÷ 17	0,005	4	4	3,5	4	77
00810803	17 ÷ 20	0,005	4	4	3,5	4	77
00811501	20 ÷ 25	0,005	4	4	7	7	78
00811502	25 ÷ 30	0,005	4	4	7	7	78
00811503	30 ÷ 35	0,005	4	4	7	7	78
00811504	35 ÷ 40	0,005	4	4	7	7	78
00812301	40 ÷ 50	0,005	4	4	11	12	84
00812302	50 ÷ 60	0,005	5	5	11	12	84
00812303	60 ÷ 70	0,005	5	5	11	12	84
00812304	70 ÷ 80	0,005	5	5	11	12	84
00812305	80 ÷ 90	0,005	5	5	11	12	84
00812306	90 ÷ 100	0,005	5	5	11	12	84
00812601	100 ÷ 125	0,01	6	6	26	18	81
00812602	125 ÷ 150	0,01	6	6	26	18	81
00812603	150 ÷ 175	0,01	7	7	26	18	81
00812604	175 ÷ 200	0,01	7	7	26	18	81
00813101	200 ÷ 225	0,01	8	8	26	18	81
00813102	225 ÷ 250	0,01	8	8	26	18	81
00813103	250 ÷ 275	0,01	8	8	26	18	81
00813104	275 ÷ 300	0,01	8	8	26	18	81











TESA IMICRO with Analogue Indication – Full Metric Sets



-  DIN 863 T4 (Style C1) NFE 11-099
-  Measuring faces on models from 3,5 to 12 mm: hardened steel, HV30 770; 11 to 100 mm: titanium nitride (TiN) hard-coating to HV5 2300. 100 to 200 mm: tungsten carbide tipped to HV5 1300.
-  Inspection report with a declaration of conformity



								
	mm	Isolated instruments	mm	Setting rings	mm	Extensions	A mm	
COMPOSITION OF THE SETS:								
00813409	BAE	3,5 ÷ 6,5	00813410 00813411 00813412 00813413	3,5 ÷ 4 4 ÷ 4,5 4,5 ÷ 5,5 5,5 ÷ 6,5	00843200 00843201	4 5,5		
00810000	BAF	6 ÷ 12	00810001 00810002 00810003	6 ÷ 8 8 ÷ 10 10 ÷ 12	00840101 00840102	8 10	00840001	100
00810800	BAG	11 ÷ 20	00810801 00810802 00810803	11 ÷ 14 14 ÷ 17 17 ÷ 20	00840103 00840105	11 17	00840301	150
00811500	BAH	20 ÷ 40	00811501 00811502 00811503 00811504	20 ÷ 25 25 ÷ 30 30 ÷ 35 35 ÷ 40	00840106 00840107	25 35	00841100	150
00812300	BAJ	40 ÷ 100	00812301 00812302 00812303 00812304 00812305 00812306	40 ÷ 50 50 ÷ 60 60 ÷ 70 70 ÷ 80 80 ÷ 90 90 ÷ 100	00840108 00840109 00840110	50 70 90	00841800	150
00812600	BAK	100 ÷ 200	00812601 00812602 00812603 00812604	100 ÷ 125 125 ÷ 150 150 ÷ 175 175 ÷ 200	00840112 00840113	125 175	00842600	150



DIN 863 T4
(Style C1)



0,001 mm
0,00005 in



LCD, 7 mm
digit height



Floating zero



Metric/inch
Conversion



Measuring faces
for application
ranges 3,5 to 12 mm:
hardened steel
(770 HV 30)
11 to 100 mm:
TiN hard-coating
(2300 HV 5)
100 to 300 mm:
carbide tipped
(1300 HV 5)



3 V Lithium battery



1 to 2 a
(≈ 2000 h/a)



Automatic shut
down after 10 min.
Display setting is
retained as long as
power supply
remains stable.



Measuring
element IP54
(IEC 60529) or
IP40 with active
data output



TESA's
calibration
certificate



Display lock







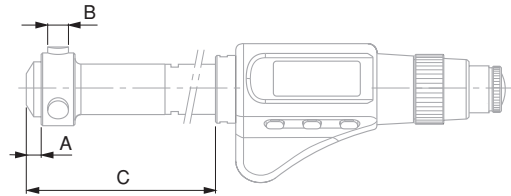

RS232
opto-coupled,
bidirectional

TESA IMICRO CAPA μ SYSTEM with Digital Display

A successful combination of the patented TESA capacitive system with the IMICRO unique cone.



No	 mm	 in	 μ m	 μ m	 A mm	 B mm	 C mm
06130101	3,5 ÷ 4	0.1377 ÷ 0.1574	4	4	2	1,5	20
06130102	4 ÷ 4,5	0.1574 ÷ 0.1771	4	4	2	1,5	20
06130103	4,5 ÷ 5,5	0.1771 ÷ 0.2165	4	4	2	1,5	25
06130104	5,5 ÷ 6,5	0.2165 ÷ 0.2559	4	4	2	1,5	25
06130105	6 ÷ 8	0.2362 ÷ 0.3150	4	4	2,5	2,5	79
06130106	8 ÷ 10	0.3150 ÷ 0.3970	4	4	2,5	2,5	79
06130107	10 ÷ 12	0.3970 ÷ 0.4724	4	4	2,5	2,5	79
06130108	11 ÷ 14	0.4330 ÷ 0.5512	4	4	3,5	4	93
06130109	14 ÷ 17	0.5512 ÷ 0.6693	4	4	3,5	4	93
06130110	17 ÷ 20	0.6693 ÷ 0.7874	4	4	3,5	4	93
06130111	20 ÷ 25	0.7874 ÷ 0.9843	4	4	7	7	91
06130112	25 ÷ 30	0.9843 ÷ 1.1811	4	4	7	7	91
06130113	30 ÷ 35	1.1811 ÷ 1.3780	4	4	7	7	91
06130114	35 ÷ 40	1.3780 ÷ 1.5748	4	4	7	7	91
06130115	40 ÷ 50	1.5748 ÷ 1.9685	4	4	11	12	104
06130116	50 ÷ 60	1.9685 ÷ 2.3622	5	5	11	12	104
06130117	60 ÷ 70	2.3622 ÷ 2.7560	5	5	11	12	104
06130118	70 ÷ 80	2.7560 ÷ 3.1496	5	5	11	12	104
06130119	80 ÷ 90	3.1496 ÷ 3.5433	5	5	11	12	104
06130120	90 ÷ 100	3.5433 ÷ 3.9370	5	5	11	12	104
06130121	100 ÷ 125	3.9370 ÷ 4.9212	6	6	26	18	100
06130122	125 ÷ 150	4.9212 ÷ 5.9055	6	6	26	18	100
06130123	150 ÷ 175	5.9055 ÷ 6.8897	7	7	26	18	100
06130124	175 ÷ 200	6.8897 ÷ 7.8740	7	7	26	18	100
06130125	200 ÷ 225	7.8740 ÷ 8.8582	8	8	26	18	100
06130126	225 ÷ 250	8.8582 ÷ 9.8425	8	8	26	18	100
06130127	250 ÷ 275	9.8425 ÷ 10.8267	8	8	26	18	100
06130128	275 ÷ 300	10.8267 ÷ 11.8110	8	8	26	18	100

OPTIONAL ACCESSORY

01961000 1 Lithium battery 3V, CR2032



TESA IMICRO CAPA μ SYSTEM with Digital Display – Full Sets

A successful combination of the TESA patented capacitive measuring system with the IMICRO unique cone.

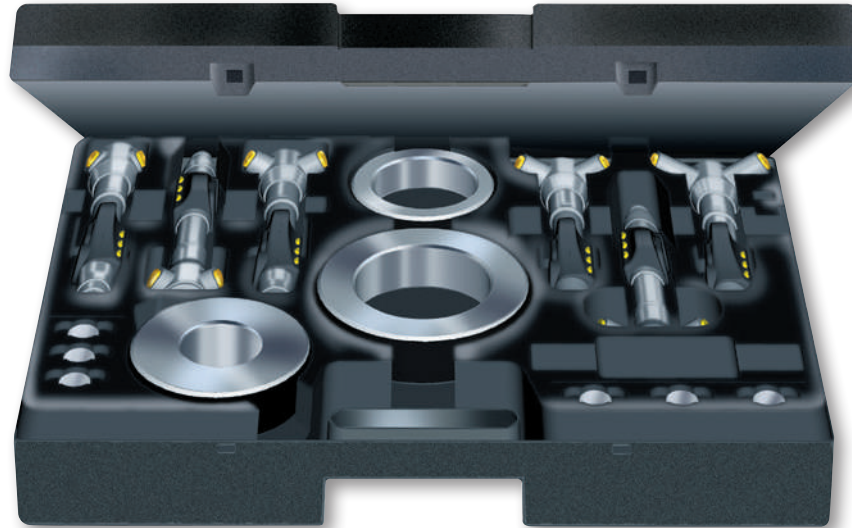

- DIN 863 T4 (Style C1)
- 0,001 mm / 0.00005 in
- LCD, 7 mm digit height
- Floating zero
- Metric/inch Conversion
- Measuring faces for application ranges 3,5 to 12 mm: hardened steel (770 HV 30)
11 to 100 mm: TiN hard-coating (2300 HV 5)
100 to 300 mm: carbide tipped (1300 HV 5)
- 3 V lithium battery
- 1 to 2 a (~ 2000 h/a)
- Automatic shut down after 10 min. Display setting is retained as long as power supply remains stable.
- Measuring element IP54 (IEC 60529) or IP40 with active data output
- TESA's calibration certificate
- Display lock
- RS 232 opto-coupled, bidirectional

	mm	Singel micrometers	mm		Setting rings mm		Extensions	mm
COMPOSITION OF THE SETS:								
06130220	3,5 ÷ 6,5	06130101	3,5 ÷ 4		00843200	4		
		06130102	4 ÷ 4,5		00843201	5,5		
		06130103	4,5 ÷ 5,5					
		06130104	5,5 ÷ 6,5					
06130221	6 ÷ 12	06130105	6 ÷ 8		00840101	8	00840001	100
		06130106	8 ÷ 10		00840102	10		
		06130107	10 ÷ 12					
06130222	11 ÷ 20	06130108	11 ÷ 14		00840103	11	00840301	150
		06130109	14 ÷ 17		00840104	17		
		06130110	17 ÷ 20					
06130223	20 ÷ 40	06130111	20 ÷ 25		00840106	25	00841100	150
		06130112	25 ÷ 30		00840107	35		
		06130113	30 ÷ 35					
		06130114	35 ÷ 40					
06130224	40 ÷ 100	06130115	40 ÷ 50		00840108	50	00841800	150
		06130116	50 ÷ 60		00840109	70		
		06130117	60 ÷ 70		00840110	90		
		06130118	70 ÷ 80					
		06130119	80 ÷ 90					
		06130120	90 ÷ 100					
06130225	100 ÷ 300	06130121	100 ÷ 125		00840112	125	00842600	150
		06130122	125 ÷ 150		00840113	175		
		06130123	150 ÷ 175					
		06130124	175 ÷ 200					



DIN 863 T4
(Style C1)



0,001 mm /
0.00005 in



LCD, 7 mm
digit height



Floating zero



Metric/inch
Conversion



Measuring faces
for application
ranges
3,5 to 12 mm:
hardened steel
(HV30 770)
11 to 100 mm:
TiN hard-coating
(HV5 2300)
100 to 300 mm:
carbide tipped
(HV5 1300)



3V lithium battery



1 to 2 a
(≈ 2000 h/a)



Automatic shut
down after 10 min.
Display setting is
retained as long as
power supply
remains stable.



Measuring element
IP54 (IEC 60529) or
IP40 with active
data output



TESA's
calibration
certificate



Display lock











RS232
opto-coupled,
bidirectional

TESA IMICRO CAPA μ SYSTEM with Digital Display – Partial Sets

A successful combination of the TESA patented capacitive measuring system with the IMICRO unique cone.



	 mm	 Elements	 Measuring heads	 mm	 Setting rings	 mm	 Extensions	 mm
COMPOSITION OF THE SETS:								
06130230	3,5 ÷ 6,5	06130010	06140020 06140021 06140022 06140023	3,5 ÷ 4 4 ÷ 4,5 4,5 ÷ 5,5 5,5 ÷ 6,5	00843200 00843201	4 5,5		
06130231	6 ÷ 12	06130011	06140024 06140025 06140026	6 ÷ 8 8 ÷ 10 10 ÷ 12	00840101 00840102	8 10	00840001	100
06130232	11 ÷ 20	06130011	06140027 06140028 06140029	11 ÷ 14 14 ÷ 17 17 ÷ 20	00840103 00840104	11 15	00840301	150
06130233	20 ÷ 40	06130011	06140030 06140031 06140032 06140033	20 ÷ 25 25 ÷ 30 30 ÷ 35 35 ÷ 40	00840106 00840107	25 35	00841100	150
06130234	40 ÷ 100	06130011	06140034 06140035 06140036 06140037 06140038 06140039	40 ÷ 50 50 ÷ 60 60 ÷ 70 70 ÷ 80 80 ÷ 90 90 ÷ 100	00840108 00840109 00840110	50 70 90	00841800	150
06130235	100 ÷ 300	06130012	06140040 06140041 06140042 06140043	100 ÷ 125 125 ÷ 150 150 ÷ 175 175 ÷ 200	00840112 00840113	125 175	00842600	150

Set available on request for extending the application range from 200 to 300 mm.



Cases for Sets of IMICRO Analogue

No	mm
00863035	3,5 ÷ 6,5
00863005	6 ÷ 12
00860008	11 ÷ 20
00860012	20 ÷ 40
00860017	40 ÷ 100
00863017	100 ÷ 200



Accessories for Both TESA IMICRO and TESA IMICRO CAPA μ SYSTEM – Extensions for Deep Hole Measurement

No	mm	A mm
00840001	6 ÷ 12	100
00840301	11 ÷ 20	150
00840302	11 ÷ 20	500
00841100	20 ÷ 40	150
00841101	20 ÷ 40	500
00841102	20 ÷ 40	1000
00841800	40 ÷ 100	150
00841801	40 ÷ 100	500
00841802	40 ÷ 100	1000
00842600	100 ÷ 300	150
00842601	100 ÷ 300	500
00842602	100 ÷ 300	1000



Cases for Single IMICRO Digital Instruments

No	mm
06160002	3,5 ÷ 40
06160003	40 ÷ 100



Centring Devices for TESA IMICRO

No	mm	A mm
00860001	40 ÷ 100	150
00862601	100 ÷ 200	200

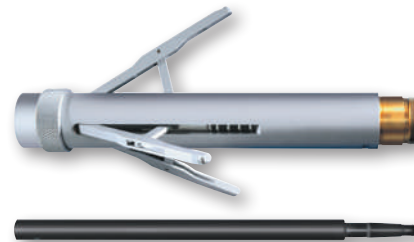

Cases for Sets of IMICRO Digital

No	mm
06160005	3,5 ÷ 20
06160006	20 ÷ 40
06160007	40 ÷ 100
00863017	100 ÷ 200



Cases for Single IMICRO Analogue Instruments

No	mm
00860007	11 ÷ 20
00860011	20 ÷ 40
00860015	40 ÷ 70
00860016	70 ÷ 100
00863016	100 ÷ 300

N NFE 11-099.
Type 1 for models
6 to 10 mm or type 2
for all other models.

 Measuring inserts
for application
range 6 to 10 mm:
steel, hardened to
550 HV 30.
10 to 300 mm:
tungsten carbide
tipped to HRC \geq 70.

 Calibration
certificate
upon request

ROCH ALESOMETER with Analogue Indication, Metric

Bore gauges with 3-line contact. All ROCH ALESOMETER let you measure not only through bores, but also blind bores as well as centring shoulders, except for the models covering the application range 6 to 10 mm.

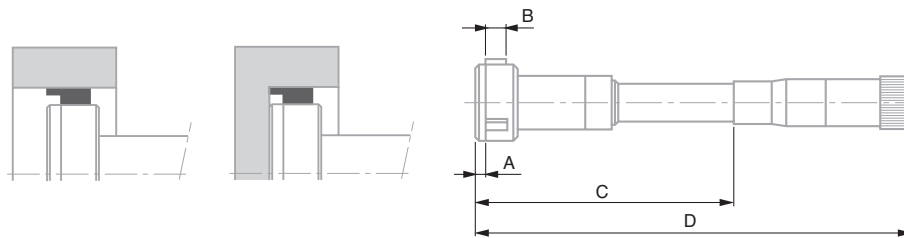

No							
	mm	mm	µm	A mm	B mm	C mm	D mm
0081725001	6 ÷ 8	0,001	4	1,2	3	54,5	107
0081725003	8 ÷ 10	0,001	4	1,2	3	54,5	107
0081725006	10 ÷ 12,5	0,001	4	0,3	6,5	64,5	117
0081725008	12,5 ÷ 15	0,001	4	0,3	6,5	64,5	117
0081725010	15 ÷ 17,5	0,001	4	0,3	6,8	64,5	117
0081725012	17,5 ÷ 20	0,001	4	0,3	6,8	64,5	117
0081725014	20 ÷ 25	0,001	4	0,3	8,5	70	122,5
0081725016	25 ÷ 30	0,001	4	0,3	8,5	70	122,5
0081725018	30 ÷ 35	0,001	4	0,3	8,5	70	122,5
0081725020	35 ÷ 40	0,001	4	0,3	8,5	70	122,5
0081725022	40 ÷ 50	0,001	4	0,3	14,5	108,7	188,7
0081725024	50 ÷ 60	0,001	5	0,3	14,5	108,7	188,7
0081725026	60 ÷ 70	0,001	5	0,3	14,5	108,7	188,7
0081725028	70 ÷ 85	0,001	5	0,3	14,5	126,7	206,7
0081725030	85 ÷ 100	0,001	5	0,3	14,5	126,7	206,7
0081725032	100 ÷ 125	0,01	7	0,3	30	153,7	233,5
0081725034	125 ÷ 150	0,01	7	0,3	30	153,7	233,5
0081725036	150 ÷ 175	0,01	8	0,3	30	153,7	233,5
0081725038	175 ÷ 200	0,01	8	0,3	30	153,7	233,5

Face A: Not applicable for models larger than 10 mm onwards, as the measuring inserts are too close to the micrometer front face.



ROCH ALESOMETER with Analogue Indication – Full Metric Sets

Bore gauges with 3-line contact. All ROCH ALESOMETER let you measure not only through bores, but also blind bores as well as centring shoulders, except for the models covering the application range 6 to 10 mm.



- NFE 11-099. Type 1 for models 6 to 10 mm or type 2 for all other models.
- Bore related tolerance: $\pm (3 \mu\text{m} + 10 \cdot 10^{-8} D) \mu\text{m}$
- Measuring inserts for application range 6 to 10 mm: steel, hardened to 550 HV 30. 10 to 300 mm: tungsten carbide tipped to HRC ≥ 70 .
- Calibration certificate upon request
- D = nominal diameter in mm ($1 \mu\text{m} + 5 \cdot 10^{-8} D) \mu\text{m}$
- Extension: hardened steel, insulated body against hand warmth
Setting rings: steel, hardened to 60 HRC.

		Single bore gauges		Setting rings		Extensions	
COMPOSITION OF THE SETS:							
0081725063	6 ÷ 10	0081725001 0081725003	6 ÷ 8 8 ÷ 10	0211625101	8	0081625081	100
0081725066	10 ÷ 20	0081725006 0081725008 0081725010 0081725012	10 ÷ 12,5 12,5 ÷ 15 15 ÷ 17,5 17,5 ÷ 20	0211625102 0211625103	12,5 17,5	0081625082	100
0081725068	20 ÷ 40	0081725014 0081725016 0081725018 0081725020	20 ÷ 25 25 ÷ 30 30 ÷ 35 35 ÷ 40	0211625104 0211625105	25 35	0081625083	150
0081725070	40 ÷ 100	0081725022 0081725024 0081725026 0081725028 0081725030	40 ÷ 50 50 ÷ 60 60 ÷ 70 70 ÷ 85 85 ÷ 100	0211625106 0211625107 0211625109	45 60 85	0081625084	150

Extensions for Depth Increase for ALESOMETERS



0081625081	6 ÷ 10	100
0081625082	10 ÷ 20	100
0081625083	20 ÷ 40	150
0081625084	40 ÷ 100	150

- Hardened steel. Insulated body against hand warmth.

 DIN 863 T4.
Style C1 for models
6 to 10 mm or style
C2 for all other
models.

 0,001 mm /
0.00005 in

 LCD, digit height
7 mm

 Floating zero

 Metric/inch
conversion

 Measuring inserts
for application range
6 to 10 mm: steel,
hardened to
550 HV 30. 10 to 300:
tungsten carbide
tipped, HRC \geq 70.

 3 V lithium battery

 1 to 2 a
(\approx 2000 h/a)

 Automatic shut
down after 10 min.
Display setting is
retained as long as
power supply
remains stable.

 For the measuring
element IP54
(IEC 60529) or
IP40 with active
data output

 Inspection report
with a declaration
of conformity





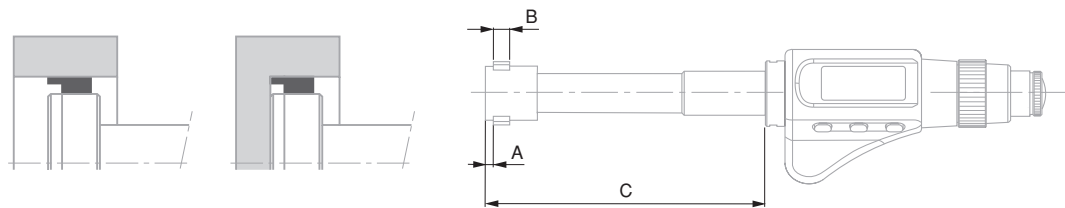
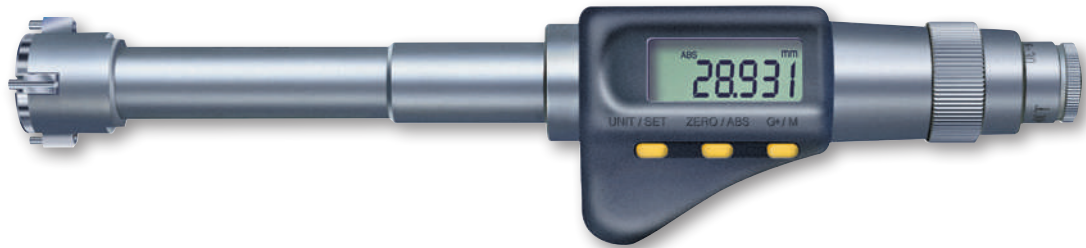

 Display lock

 RS232
opto-coupled,
bidirectional

TESA ALESOMETER CAPA μ SYSTEM with Digital Display

Fitted with a TESA patented capacitive measuring system. Bore gauges with 3-line contact. All TESA ALESOMETER are made to measure through and blind bores as well as short centring shoulders, except for the models covering the application range from 6 to 10 mm.



No	 mm	 in	 μ m	 μ m	 A mm	 B mm	 C mm
06230051	6 ÷ 8	0.2362 ÷ 0.3150	4	4	1,2	3	55
06230052	8 ÷ 10	0.3150 ÷ 0.3970	4	4	1,2	3	55
06230023	10 ÷ 12,5	0.3970 ÷ 0.4921	4	4	0,3	6,5	65
06230024	12,5 ÷ 15	0.4921 ÷ 0.5905	4	4	0,3	6,5	65
06230025	15 ÷ 17,5	0.5905 ÷ 0.6890	4	4	0,3	6,8	65
06230026	17,5 ÷ 20	0.6890 ÷ 0.7874	4	4	0,3	6,8	95
06230027	20 ÷ 25	0.7874 ÷ 0.9843	4	4	0,3	8,5	100
06230028	25 ÷ 30	0.9843 ÷ 1.1811	4	4	0,3	8,5	100
06230029	30 ÷ 35	1.1811 ÷ 1.3780	4	4	0,3	8,5	100
06230030	35 ÷ 40	1.3780 ÷ 1.5748	4	4	0,3	8,5	100
06230031	40 ÷ 50	1.5748 ÷ 1.9685	4	4	0,3	14,5	140
06230032	50 ÷ 60	1.9685 ÷ 2.3622	5	5	0,3	14,5	140
06230033	60 ÷ 70	2.3622 ÷ 2.7560	5	5	0,3	14,5	140
06230034	70 ÷ 85	2.7560 ÷ 3.3465	5	5	0,3	14,5	140
06230035	85 ÷ 100	3.3465 ÷ 3.9370	5	5	0,3	14,5	140
06230036	100 ÷ 125	3.9370 ÷ 4.9212	6	6	0,3	30	175
06230037	125 ÷ 150	4.9212 ÷ 5.9055	6	6	0,3	30	175
06230038	150 ÷ 175	5.9055 ÷ 6.8897	7	7	0,3	30	175
06230039	175 ÷ 200	6.8897 ÷ 7.8740	7	7	0,3	30	175

OPTIONAL ACCESSORY

01961000 1 Lithium battery 3V, CR2032





Face A: Not applicable for models larger than 10 mm onwards, as the measuring inserts are too close to the micrometer front face.





TESA ALESOMETER CAPA μ SYSTEM with Digital Display - Partial Sets and Components







Fitted with TESA patented capacitive measuring system. Models that cover the application range from 6 to 10 mm can only measure through bores – All other partial sets also allow blind bores as well as short centring shoulders to be inspected.



-  DIN 863 T4. Style C1 for models 6 to 10 mm or C2 for all other models
-  0,001 mm / 0.00005 in
-  Measuring inserts for application range 6 to 10 mm: steel, hardened to 550 HV 30. 10 to 300: tungsten carbide tipped to HRC \geq 70.
-  Inspection report with a declaration of conformity

 No	 mm	 No	Measuring heads	 mm	 No	Connectors	 No	Measuring elements	 No	Setting rings	 mm	 No	Storage case
COMPOSITION OF THE SETS:													
06230100	6 ÷ 10	0081720351	6 ÷ 8	0081620491	06230020	0211625101	8	06260001					
		0081720353	8 ÷ 10										
06230110	10 ÷ 20	0081720356	10 ÷ 12,5	0081620492	06230020	0211625102	12,5	06260001					
		0081720358	12,5 ÷ 15			0211625103	17,5						
		0081720360	15 ÷ 17,5										
		0081720362	17,5 ÷ 20										
06230111	20 ÷ 40	0081720364	20 ÷ 25	0081620493	06230020	0211625104	25	06260001					
		0081720366	25 ÷ 30			0211625105	35						
		0081720368	30 ÷ 35										
		0081720370	35 ÷ 40										
06230112	40 ÷ 100	0081720372	40 ÷ 50	0081620494	06230020	0211625106	45	0081629525					
		0081720374	50 ÷ 60			0211625107	60						
		0081720376	60 ÷ 70			0211625109	85						
		0081720378	70 ÷ 85										
		0081720380	85 ÷ 100										

Set available on request for extending the application range from 100 to 300 mm.





-  Models from 10 to 100 mm:
DIN 863 T4
(Style C2)
NFE 11-099
-  Max. perm. error for models covering the application ranges from
5 to 40 mm = 3 μ m
40 to 100 mm = 4 μ m
100 to 200 mm = 5 μ m
-  Repeatability limit for models covering the application ranges from
5 to 40 mm = 3 μ m
40 to 100 mm = 4 μ m
100 to 200 mm = 5 μ m
-  Measuring bolts on models from 5 to 100 mm:
hardened steel.
100 to 200 mm:
tungsten carbide tipped
-  Inspection report with a declaration of conformity
-  Models from 5 to 100 mm:
0,002 mm
Models 100 to 200 mm with vernier reading: 0,01 mm

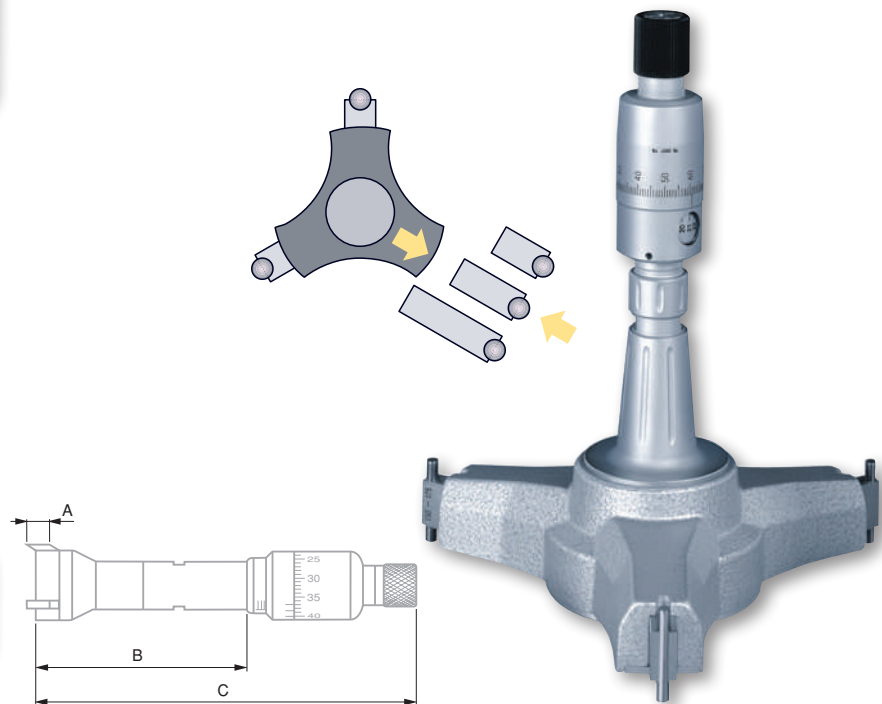

ETALON INTALOMETER 531

Made to check through holes, blind bores and short centring shoulders. All models covering the application range up to 100 mm have sloped bolts extending beyond the front face of the measuring head.



No					
	mm		A mm	B mm	C mm
078112356	5 ÷ 6	2 x 180°	3	≥ 32	≤ 109
078112357	6 ÷ 7	2 x 180°	3	≥ 33	≤ 111
078112358	7 ÷ 8,5	2 x 180°	4	≥ 60	≤ 130
078112359	8,5 ÷ 10	2 x 180°	4	≥ 72	≤ 133
078112360	10 ÷ 12,5	3 x 120°	3	≥ 60	≤ 118
078112361	12,5 ÷ 15	3 x 120°	3	≥ 63	≤ 120
078112362	15 ÷ 17,5	3 x 120°	3	≥ 65	≤ 122
078112363	17,5 ÷ 20	3 x 120°	3	≥ 68	≤ 125
078112364	20 ÷ 25	90°-135°-135°	7	≥ 75	≤ 132
078112365	25 ÷ 30	90°-135°-135°	7	≥ 90	≤ 138
078112366	30 ÷ 35	90°-135°-135°	7	≥ 90	≤ 142
078112367	35 ÷ 40	90°-135°-135°	7	≥ 90	≤ 148
078112368	40 ÷ 45	90°-135°-135°	10,5	≥ 110	≤ 167
078112369	45 ÷ 50	90°-135°-135°	10,5	≥ 113	≤ 170
078112370	50 ÷ 60	90°-135°-135°	15	≥ 123	≤ 187
078112371	60 ÷ 70	90°-135°-135°	15	≥ 130	≤ 193
078112372	70 ÷ 85	90°-135°-135°	15	≥ 145	≤ 213
078112373	85 ÷ 100	90°-135°-135°	15	≥ 155	≤ 224
078110733	100 ÷ 125	3 x 120°	27	≥ 105	≤ 194
078110735	125 ÷ 150	3 x 120°	27	≥ 105	≤ 194
078110737	150 ÷ 175	3 x 120°	27	≥ 105	≤ 194
078110739	175 ÷ 200	3 x 120°	27	≥ 105	≤ 194







Measuring range up to 300 mm available upon request.











ETALON INTALOMETER 531, Metric Sets

Made to check through holes, blind bores and short centring shoulders. All models covering the application range up to 100 mm have sloped bolts extending beyond the front face of the measuring head.



-  Models from 10 to 100mm:
DIN 863 T4
(Style C2)
NFE 11-099
-  Max. perm. error for models covering the application ranges from
5 to 40 mm = 3 µm
40 to 100 mm = 4 µm
100 to 200 mm = 5 µm
-  Repeatability limit for models covering the application ranges from
5 to 40 mm = 3 µm
40 to 100 mm = 4 µm
100 to 200 mm = 5 µm
-  Measuring bolts on models from 5 to 100 mm:
hardened steel.
100 to 200 mm:
tungsten carbide tipped.
-  Inspection report with a declaration of conformity
-  Models from 5 to 100 mm = 0,002 mm on vernier,
100 to 200 mm = 0,01 mm

	 mm	 Isolated instruments	 mm	 Setting rings	 mm	 Extensions	 mm
COMPOSITION OF THE SETS:							
078110592	5 ÷ 10	078112356	5 ÷ 6	00840114	6	078103613	100
		078112357	6 ÷ 7	00840115	8,5		
		078112358	7 ÷ 8,5				
		078112359	8,5 ÷ 10				
078110594	10 ÷ 20	078112360	10 ÷ 12,5	00840116	12,5	078103621	150
		078112361	12,5 ÷ 15	00840117	17,5		
		078112362	15 ÷ 17,5				
		078112363	17,5 ÷ 20				
078110596	20 ÷ 40	078112364	20 ÷ 25	00840106	25	078103624	150
		078112365	25 ÷ 30	00840107	35		
		078112366	30 ÷ 35				
		078112367	35 ÷ 40				
078110598	40 ÷ 100	078112368	40 ÷ 45	00843230	45	078104940	150
		078112369	45 ÷ 50	00843239	60		
		078112370	50 ÷ 60	00840118	85		
		078112371	60 ÷ 70				
		078112372	70 ÷ 85				
		078112373	85 ÷ 100				

N DIN 863 T4
(Style C2)
NFE 11-099

000 0,01 mm

Tungsten carbide
tipped measuring
bolts and cone

Inspection report
with a declaration
of conformity

|| 0,002 mm

Supplied with 1 heat
insulating sleeve
(No. 00940020),
2 keys (No. 00940001),
1 screwdriver
(No. 00862801).

TESA TRI-O-BOR

Self-centring and self-aligning internal micrometers with 3-line contact with the part being inspected.

These micrometers measure trough holes, blind bores and short centring shoulders.

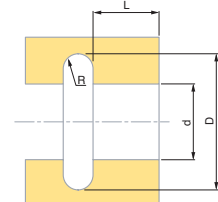
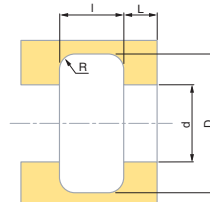
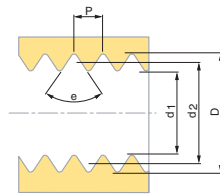
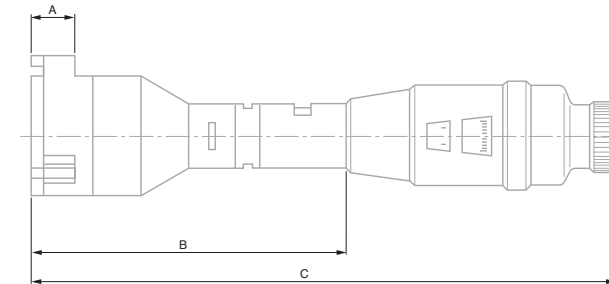
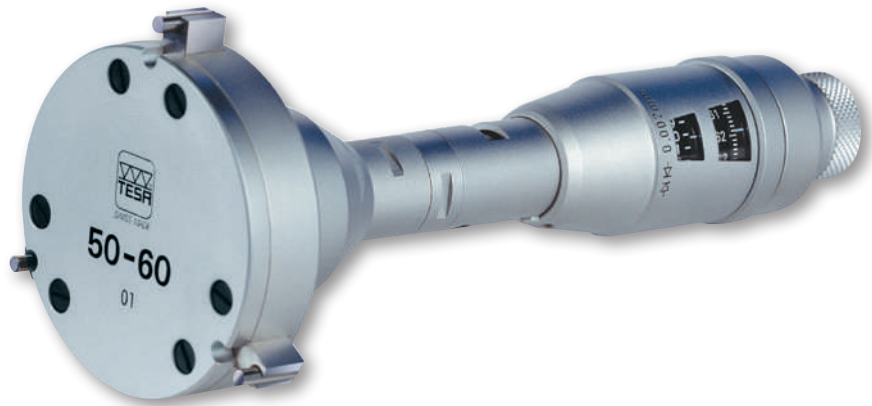

No						
	mm	µm	µm	A mm	B mm	C mm
00910005	15 ÷ 20	4	4	6	≥ 66	≤ 132
00910006	20 ÷ 25	4	4	6	≥ 66	≤ 132
00910007	25 ÷ 30	4	4	6	≥ 66	≤ 132
00910405	30 ÷ 40	4	4	10	≥ 70	≤ 138
00910406	40 ÷ 50	4	4	10	≥ 70	≤ 138
00910407	50 ÷ 60	5	5	10	≥ 70	≤ 138
00910705	60 ÷ 70	5	5	18	≥ 78	≤ 147
00910706	70 ÷ 80	5	5	18	≥ 78	≤ 147
00910707	80 ÷ 90	5	5	18	≥ 78	≤ 147
00911105	90 ÷ 100	5	5	18	≥ 78	≤ 147
00911106	100 ÷ 110	6	6	18	≥ 78	≤ 147
00911107	110 ÷ 120	6	6	18	≥ 78	≤ 147

OPTIONAL ACCESSORY

00940000 Extension of 150 mm for TESA TRI-O-BOR



TESA TRI-O-BOR, Full Sets

Self-centring and self-aligning internal micrometers with 3-line contact with the part being inspected.

These micrometers measure through holes, blind bores and short centring shoulders.

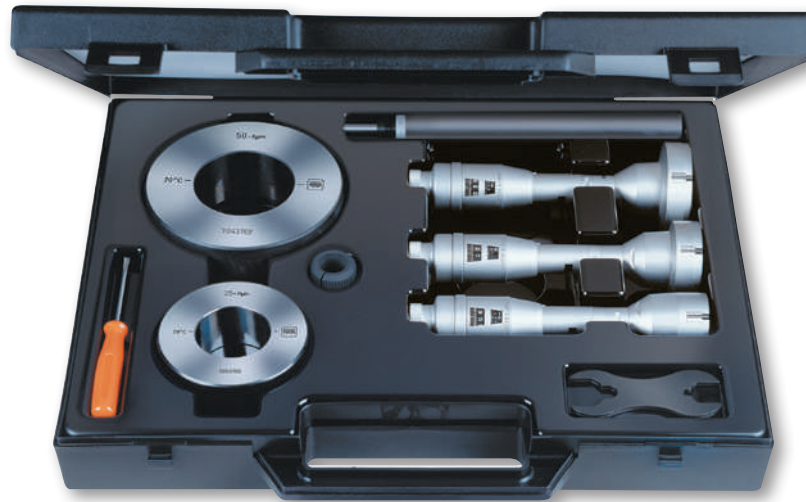

- DIN 863 T4 (Style 2) NFE 11-099
- 0,01 mm
- Tungsten carbide tipped measuring bolts and cone
- Inspection report with a declaration of conformity
- 0,002 mm
- Supplied with 1 heat insulating sleeve No 00940020, 2 key No 00940001, 1 screwdriver No 00862801

		mm	Single micrometers	mm	Setting rings	mm	Extensions	mm

COMPOSITION OF THE SETS:

00910004	BSC	15 ÷ 30	00910005	15 ÷ 20	00840104	15	00940000	150
			00910006	20 ÷ 25	00840106	25		
			00910007	25 ÷ 30				
00910404	BSD	30 ÷ 60	00910405	30 ÷ 40	00840107	35	00940000	150
			00910406	40 ÷ 50	00840108	50		
			00910407	50 ÷ 60				
00910704	BSF	60 ÷ 90	00910705	60 ÷ 70	00840109	70	00940000	150
			00910706	70 ÷ 80	00840110	90		
			00910707	80 ÷ 90				
00911104	BSG	90 ÷ 120	00911105	90 ÷ 100	00840110	90	00940000	150
			00911106	100 ÷ 110	00840111	110		
			00911107	110 ÷ 120				

Extension for Depth Increase TESA TRI-O-BOR



00940000	150

SETTING STANDARDS FOR INTERNAL MICROMETERS

TESA Setting Rings and Setting Masters

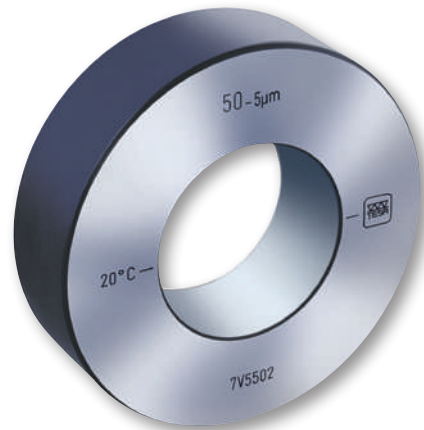

Setting ring 50 mm

Setting standard 225-275 mm

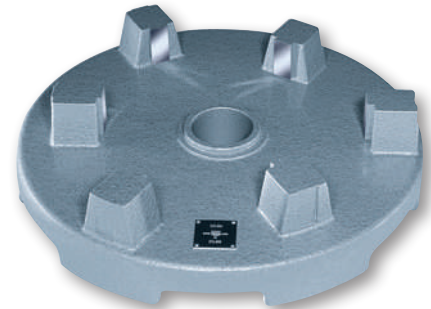

No	∅	ρ	μm^*	μm^{**}
00843200	4	1,5	1,5	1,5
00843201	5,5	1,5	1,5	1,5
00840114	6	1,5	1,5	1,5
00840101	8	1,5	1,5	1,5
00840115	8,5	1,5	1,5	1,5
00840102	10	1,5	1,5	1,5
00840103	11	1,5	1,5	1,5
00840116	12,5	1,5	1,5	1,5
00840104	15	1,5	1,5	1,5
00840105	17	1,5	1,5	1,5
00840117	17,5	1,5	1,5	1,5
00840106	25	1,5	1,5	1,5
00840107	35	2	2	2
00843230	45	2	2	2
00840108	50	2	2	2
00843239	60	2	2	2
00840109	70	2	2	2
00840118	85	2	2	2
00840110	90	2	2	2
00840111	110	2,5	2,5	2,5
00840112	125	2,5	2,5	2,5
00840113	175	2,5	4	4
00843101	225, 275	-	6	6

* Making no allowance for a rim of 1 mm.

** All listed values are determined through a 2-point measurement taken at half-height of the setting ring. The measuring direction is marked with 2 strokes. The measured actual dimension is engraved on every setting master.





Measuring Instruments for Large Dimensions



TESA – THE SPECIALISTS FOR LONG LENGTHS

For large dimensions from 250 mm up to several meters, TESA offers various types of measuring instruments that have long proven their value in practical use.

Whatever the sizes, from a simple distance between two surfaces parallel to one another measurement is always a challenge. Apart from the usual influences, which are proportional to the size whilst adding to your contributions in the uncertainty budget, those due to gravity play a key role in distortion.

Large sizes in mechanical engineering generally mean dimensions in excess of 500 mm. Various measurement procedures are brought into play, using such items as large internal and external micrometers with two-point contact, periphery tapes (for outside diameters), V-bases, rotating measuring disks (rolling-contact) optical systems (triangulation with theodolite), fixed gauges (inside caliper gauges), gauge blocks combinations or adjustable telescopic gauges.

There are other methods that often call for very simple techniques, such as fixed gauges (caliper gauges), combinations of gauge blocks, or even adjustable telescopic gauges.

Here's an example of a proportional relationship. With a bore of $\varnothing 1200$ H7, the tolerance area matches 0,1 mm. Reducing both values by a factor of 100 would give a manufacturing tolerance as low as $1 \mu\text{m}$. Of course, things are not as simple, but this example gives some ideas about the proportions.



- DIN 863 T4 (Style B)
- Micrometer: 25 mm
- Dial gauge: ± 0,22 mm
- Micrometer and dial gauge: 0,01 mm
- Micrometer: 0,1 mm
- 8 µm
- Measuring bolts: Spherical and for measuring in the micrometer axis. All inserts are interchangeable
- Extension: 1 spherical and 1 flat measuring face
- 0,5 mm
- Tungsten carbide tipped
- 0,7 to 1N
- Extension: 26 mm dia. steel tube with snap-ring system. Also with built in gauge rods.
- Wooden case
- Setting standard with identification number
- Calibration certificate:
 - per setting standard
 - per measuring element
 - per extension

TESA UNITEST Internal Micrometer

Measures internal dimensions in the micrometer's axis with 2-point contact with the workpiece to be checked – Optional accessories are available for inspecting centring shoulders and blind bores along with auxiliary means for external measuring.

Extensions with built-in gauge rods can be mounted on the measuring element, thus allowing any dimension within the application range to be measured, directly.

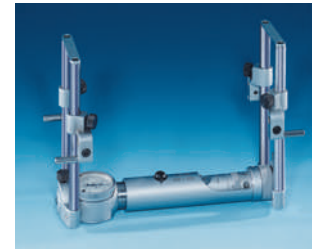
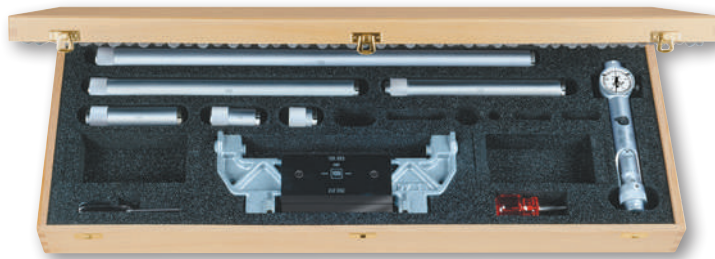

No	=		mm		mm		µm
01110700	UNITEST (SET)		Internal dimensions 200 ÷ 1400				
CONSISTING OF:							
01110901	Measuring head		Internal dimensions 200 ÷ 225				
01141001	Setting gauge		Internal / external dimensions	200			
01110801	Extension			25			0,7
01110802	Extension			50			1
01110804	Extension			100			1,5
01110808	Extension			200			2,5
01110812	Extension			300			3,5
01110820	Extension			500			5,5
01160901	Screwdriver						
01162302	Case for Unitest						
OPTIONAL ACCESSORIES:							
01160701	Pair of tungsten carbide tipped measuring bolts for blind bores						
01162301	Auxiliary elements for external measurement				Measuring depth: ≤ 10		
01140801	Suspension device, complete				Measuring depth : ≤ 100		



TESA UNIMASTER Universal Measuring Instrument

TESA UNIMASTER Universal Measuring Instrument provides the features necessary for direct measurement of specially large internal and external dimensions. TESA UNIMASTER is similar to internal micrometers with two-point contact with the workpiece being measured. Measures any dimension within the extended application range directly by simply adding the needed extensions with built-in gauge blocks to the measuring element.

Accurate, robust and easy-to-handle – Can be used either vertically or horizontally with a constant measuring force – Incorporates a lever-type dial test indicator that clearly shows the culmination point – Ensures stable measuring owing to both a negligible deflection and thermal protection on each extension.

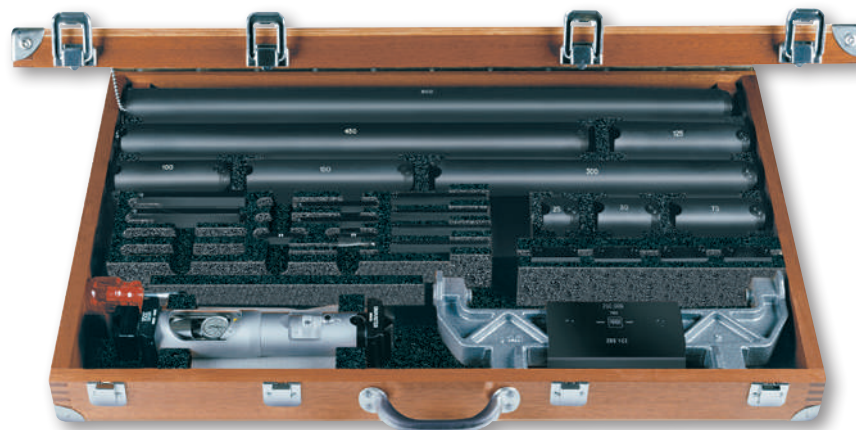
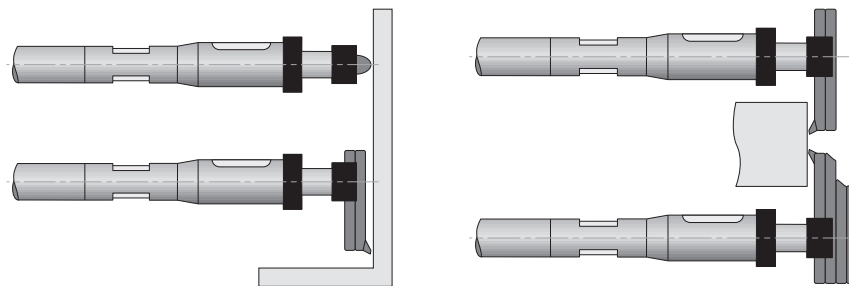
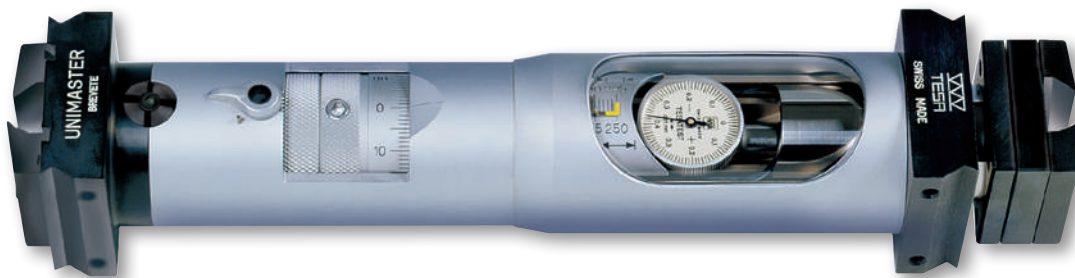

- DIN 863 T4 (Style B)
- Micrometer: 25 mm
- Dial test indicator: ± 0,4 mm
- Micrometer and dial test indicator: 0,01 mm
- 5 µm
- One spherical and one flat measuring faces
- 1 mm
- Tungsten carbide tipped
- 15 to 20 N measuring force reversible between internal and external directions
- Measuring bolts supplied in pairs:
 - No. 01110203 for internal measuring in the micrometer axis.
 - No. 01110205 for internal/external measuring, meas. depth up to 60 mm from the lower edge of the micrometer.
 - No. 01110208, extra-rigid for external measuring, meas. depth up to 75 mm from the lower edge of the micrometer.
- Extension: 38 mm dia. diameter steel tube with snap ring system. Built-in gauge rod.
- Mobile ball-bearing anvil under spring pressure.
- Wooden case
- Measuring element and setting standard with identification number
- Calibration certificate:
 - per setting standard
 - per measuring element
 - per extension



No	=	mm	mm			
01110000	TESA UNIMASTER metric full	Int. dim. 250 ÷ 1475*	Ext. dim. 225 ÷ 1450*			
CONSISTING OF:						
No	=	mm	mm	mm	mm	µm
01110300	Measuring element UNIMASTER	Int. dim. 250 ÷ 275	Ext. dim. 225 ÷ 250			
01110203	Set measuring arms interior dimensions					
01110205	Set measuring arms for interior and exterior dimensions, length 75mm			75		
01110208	Set measuring arms for interior and exterior dimensions, length 100mm			100		
01110501	Setting gauge			Int. dim.: 250	Ext. dim. : 225	
01110101	Extension			25		0,7
01110102	Extension			50		1
01110103	Extension			75		1,2
01110104	Extension			100		1,5
01110105	Extension			125		1,5
01110106	Extension			150		2
01110112	Extension			300		3,5
01110118	Extension			450		4,5
01110124	Extension			600		6,5
01130001	Special screwdriver					
01110401	Set of suspension accessories (4 brackets together with 4 clamps)					
01112401	Wooden case for complete set					
OPTIONAL ACCESSORIES:						
01110140	Extension 1000 mm			1000		10
01162001	Anvils for internal/external dimensions and throats			Measuring depth: ≤ 20	Tungsten carbide inserts: Ø 4 x 7	
01160001	Roller (2 items are needed)					

*Using 3 extensions at the very most.

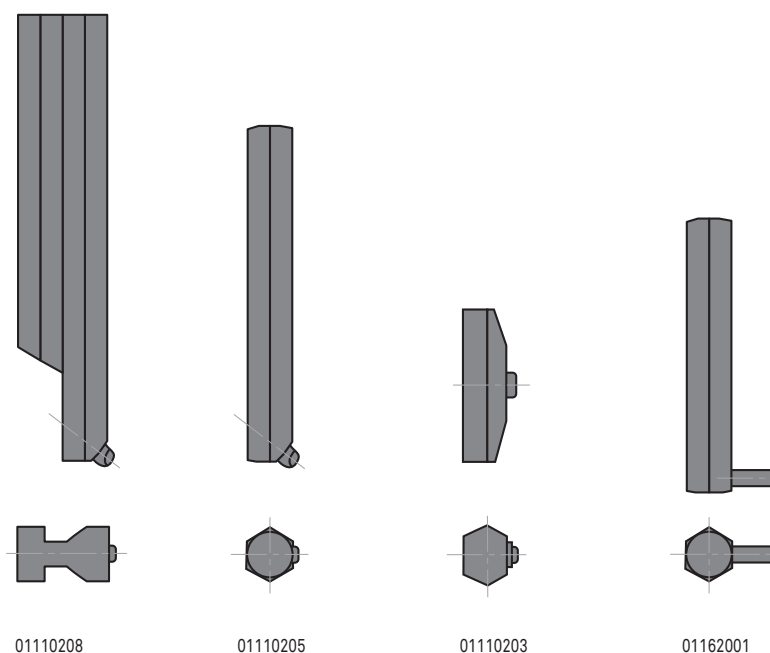

01110208

01110205

01110203

01162001





TESA INOTEST Comparative Measuring Instrument

Allows for comparative measurement of large internal or external dimensions. Consists of a measuring element with interchangeable inserts as well as a set of extensions. Since there is no material measure, the indication is set using a separate standard that can either be a gauge block, setting ring or horizontal measuring bench.

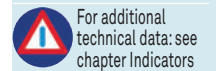
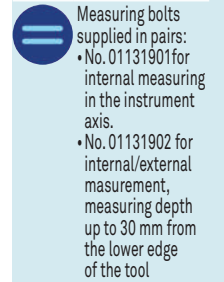
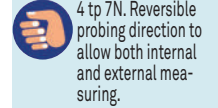
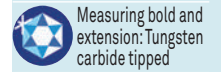
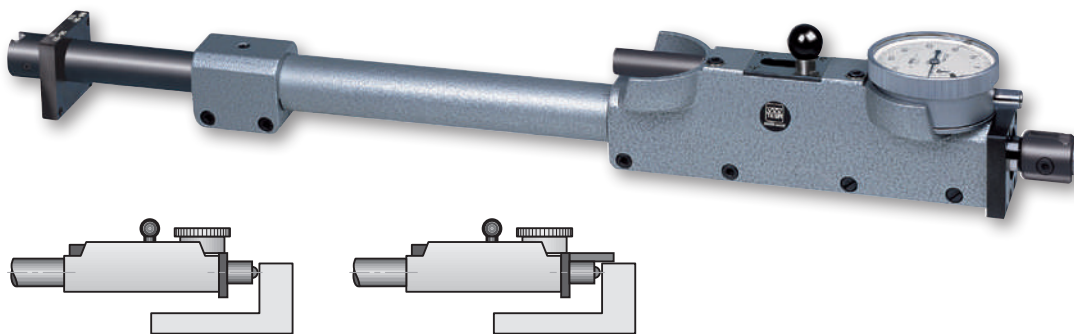
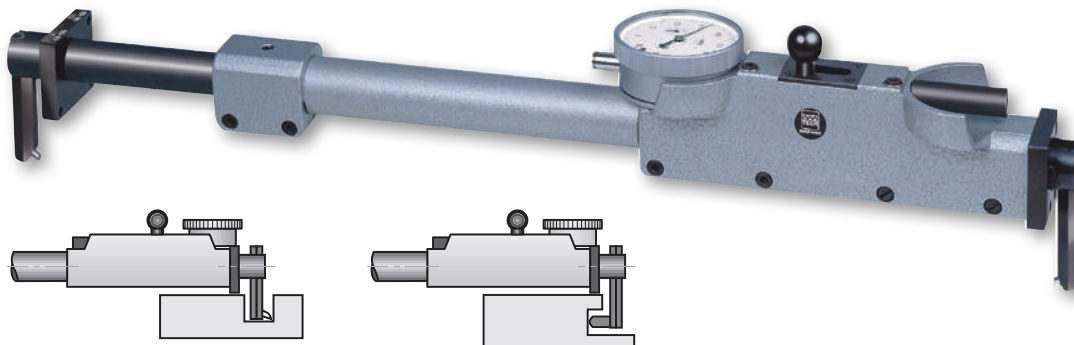
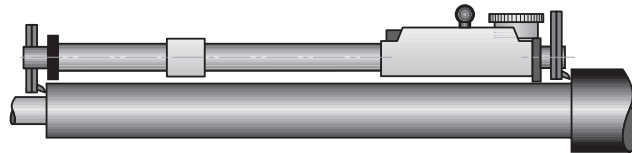
Measuring inserts for inspection in the tool axis, or offset inserts – Vertical or horizontal position of use – Integrated dial gauge to show the culmination point – Constant measuring force – Extensions with heat insulating grip.

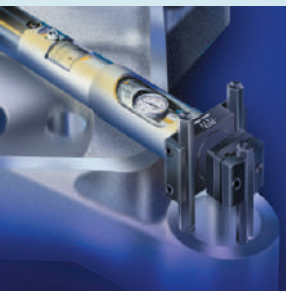



No	=		
01111900	TESA INOTEST complete set	mm Int. dim. 275 ÷ 1025	mm Ext. dim. 250 ÷ 1010
CONSISTING OF:			
No	=		
01112301	Measuring element INOTEST	mm	
01131901	Pair of inserts for internal measuring		
01131902	Pair of inserts for internal and external measuring, length 60 mm	60	
01132001	Set of 4 mounting rods	∅ 7 x 40	
00160101	3 insulating grips (reference code is for 1 item)		
01112001	Extension 250 ÷ 310 mm	Int. dim.: 275 ÷ 335	Ext. dim.: 250 ÷ 310
01112002	Extension 300 ÷ 410 mm	Int. dim.: 325 ÷ 435	Ext. dim.: 300 ÷ 410
01112003	Extension 400 ÷ 610 mm	Int. dim.: 425 ÷ 635	Ext. dim.: 3400 ÷ 610
01112004	Extension 600 ÷ 1010 mm	Int. dim.: 625 ÷ 1035	Ext. dim.: 600 ÷ 1010
01162303	Case INOTEST		
OPTIONAL ACCESSORIES:			
01141901	Extension 500 mm	500	
01141902	Extension 1000 mm	1000	
01162001	Carbide measuring inserts for throats	Measuring depth: ≤ 20	Tungsten carbide inserts: ∅ 4 x 7
01161900	Device for small dimensions, Inotest	Int. dim. 35 ÷ 280	Ext. dim. 15 ÷ 255

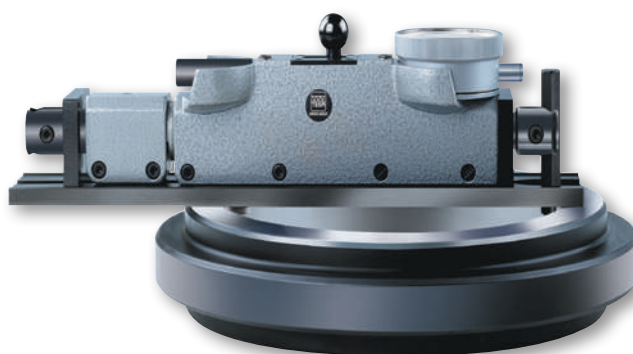

ETALON 532 Internal Micrometer

This micrometer is designed for measurements with 2-point contact.

Extensions with built-in gauge rods can be used to increase the measuring range – Stiff screw coupling.



- Factory standard
- 15 mm
- 0,01 mm
- Spheric (R = 15 mm)
- 29 mm
- 0,5 mm
- Tungsten carbide tipped
- Reference gauge rods
- Wooden case

Full set:			072109101	072109107	072109108	072109117	072109128
		mm	50 ÷ 170	50 ÷ 290	50 ÷ 530	50 ÷ 1010	50 ÷ 1510

COMPOSED BY:

		mm	mm	µm					
072103576	Micrometrical element	50 ÷ 65		3	•	•	•	•	•
072103585	Extention		15	1,5	•	•	•	•	•
072105462	Extention		30	1,5	•	•	•	•	•
072109030	Extention		60	2	•	•	•	•	•
072103586	Extention		120	2		•	•	•	•
072109055	Extention		240	3			•	•	•
072109066	Extention		480	3,5				•	•
072109089	Extention		500	3,5					•

ROCH Metric Periphery Tapes

Steel tapes with a dual graduation for measuring external circumferences and diameters of cylindrical parts on machines and other fittings – Suitable for malleable parts such as plastic tubing – Used for inspecting tanks or boilers – Also designed for checking steel or concrete pipes, rims, tires etc.

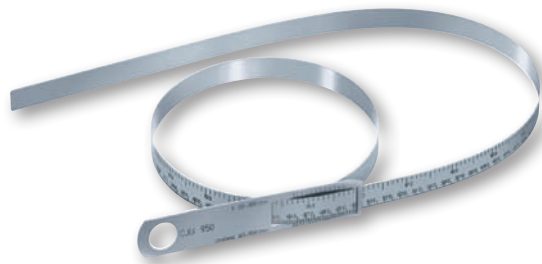

	Diameter, mm	Circumference, mm	mm
0951750222	20 ÷ 30	60 ÷ 950	0,15
0951750223	300 ÷ 700	940 ÷ 2200	0,20
0951750224	700 ÷ 1100	2190 ÷ 3460	0,20
0951750225	1100 ÷ 1500	3450 ÷ 4720	0,25

- 0,1 mm
- 16 x 0,2 mm type section
- Steel band

Dial gauges – Electronic and Analogue



EASY-TO-USE AND VERSATILE

For more than 50 years we have been producing and distributing a wide range of easy-to-use and versatile dial gauges. Our experience allows us to offer a wide choice of different models.

- Electronic indicators with combined analogue/digital display using the most up-to-date technology.
- Mechanical dial gauges equipped with high-precision movements and double-action shockproof mechanisms. Measuring spans up to 100 mm.

CHOICE OF DIAL GAUGE OR ELECTRONIC INDICATOR

- Digital indication provides error-free reading of the measured value. There is no need to read fractions of scale divisions.
- Analogue indication offers the advantage of being able to smoothly adjust the increase or decrease of the dimension to be measured on the workpiece. This type of indication is best suited for dynamic measurements such as determining axial and radial runout errors.
- Electronic indicators provide many additional functions compared to the mechanical models. For more information, refer to the section on electronic indicators.
- The inspection of axial and radial runout errors frequently requires the use of instruments with the lowest hysteresis characteristic. Our electronic indicators, precision dial gauges and dial test indicators meet this requirement.
- In order to significantly reduce the effect of systematic errors, it is recommended to carry out comparative measurements. Only deviations from the nominal dimension will be displayed. High precision, small range electronic indicators are the ideal instruments for these types of measurements.
- These same instruments also enable avoiding major errors in reading millimetres.

STANDARDS AND DEFINITIONS

The international ISO 463:2006 standard replaces national standards dealing with mechanical dial gauges. All the same, new definitions and standard requirements pertaining to measuring procedures, although valid, imply changes in design and metrological characteristics, which cannot be entirely indicated in this catalogue. This standard, is defined in the matrix "Product Specification (GPS) - dimensional measuring instruments". It only defines the requirements for the most important characteristics.

Therefore, all tolerance limits indicated in this catalogue which refer to metrological characteristics are based on our own internal standards.

Electronic indicators and short range precision indicators. Definitions used in this section:



Total permissible error in 1 measuring direction over the entire measuring range within the partial measuring range

in the 2 measuring directions



Repeatability limit



Max. hysteresis

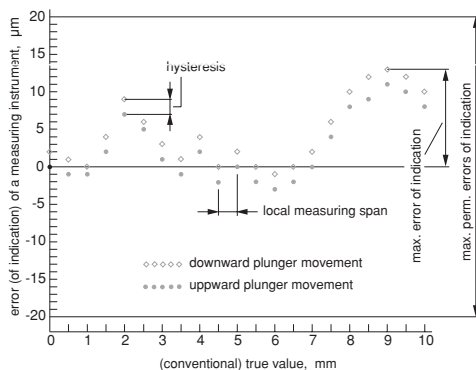

Mechanical dial gauges.

Definitions used in this section for the maximum permissible errors of a metrological characteristic (MPE):



Deviation span (error of indication within the measuring range)

Deviation span (error of indication) within the partial measuring range

Total deviation span (error of indication within the measuring range)



Repeatability limit (reliability) of indication



Hysteresis of indication

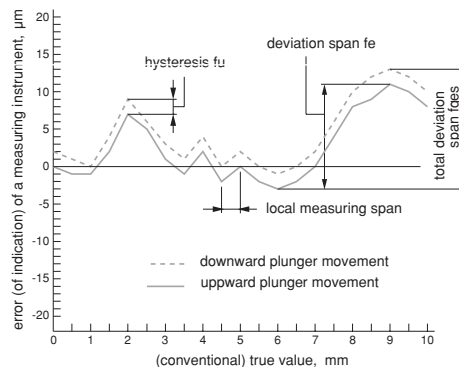

- Resolution 0,01 mm = ±0,25 mm
Resolution to 0,001 mm = ±0,025 mm
- 6-decade LC display field, plus minus sign
- Digit size 10 x 5 mm (H x L)
- Combined analogue and numerical display
- Glass scale with incremental divisions, capacitive
- MI or MIE type: metric/inch conversion
- ≤ 2 N
- ≤ 2 m/s
- Full-metal housing with front face in polyamide. Stainless steel plunger. M2,5 mounting thread for measuring insert.
- RS232, opto-coupled
- 3V lithium battery type CR2032
- 1 year to 2 years
- EN 50081-1
EN 50082-1
- 150 g
- Transport case with 1 lithium battery 01961000
- Inspection report with declaration of conformity

TESA DIGICO 205 / 305

- Dual LC Display, digital and analogue.
- Mechanical tolerance markers.
- Dimensions according to DIN 878.

Main functions

ON/Auto OFF – Data output – Counting sense reversal – Keypad lock.

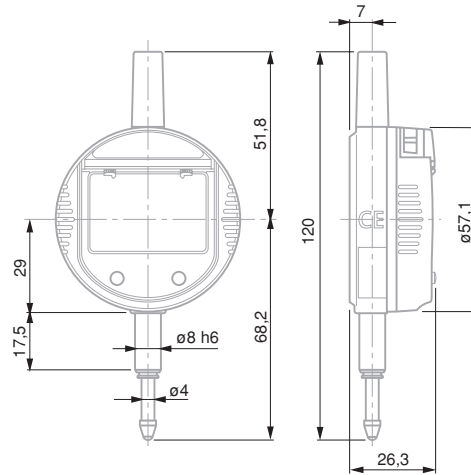

No	=						
		mm	in	mm	in	µm	µm
01930230	DIGICO 205 MI	12,5	0.5	0,01	0.0005	20	10
01930231	DIGICO 305 MI	12,5	0.5	0,001	0.00005	8	2



TESA DIGICO 400 / 500

- Measuring modes ABS/REL.
- Dual LC Display, digital and analogue
- Rotation through 270° of display and key functions.
- Mechanical tolerance marks.
- Graphical display of tolerance limits.

Measuring functions and modes

ON – Auto OFF – PRESET mode – Tolerance mode – Data output – Counting sense reversal – Keypad lock – Metric/Inch units – Full RESET.

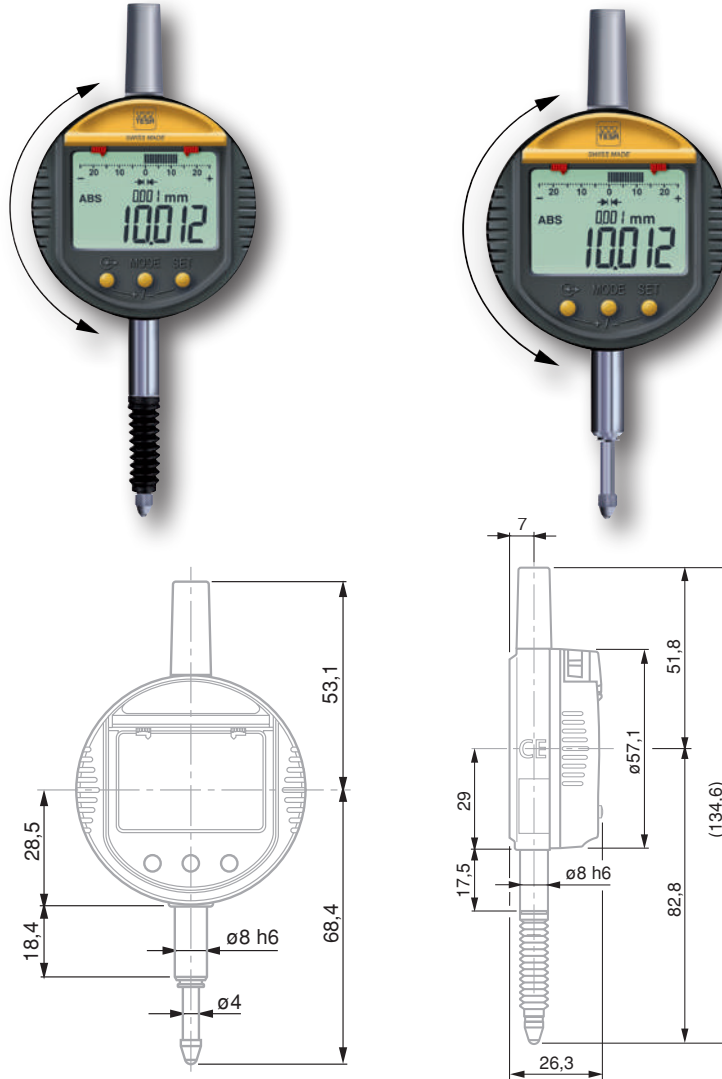

- Resolution 0,01 mm
= $\pm 0,25$ mm Resolution
0,001 mm = $\pm 0,025$ mm
- 6-decade LC display
field plus minus sign
- Digit size 10 x 5
(H x L)
- Combined analogue
and numerical
display
- Glass scale with in-
cremental divisions,
capacitive
- Conversion mm/in
- Measuring force:
< 2 N
- ≤ 2 m/s
- Full-metal housing,
front face in
polyamide, Stainless
steel plunger,
M2,5 mounting
thread for mea-
suring insert.
- RS232,
opto-coupled
- 3V lithium battery,
type CR2032
- 1 year to 2 years
- EN 50081-1
EN 50082-1
- Shipping case in-
cluding one lithium
battery 01961000
- Inspection report
with declaration of
conformity

No	=								
		mm	in	mm	in	μm	μm		g
01930240	DIGICO 405 MI	12,5	0.5	0,01	0.0005	20	10	-	150
01930241	DIGICO 410 MI	25	1	0,01	0.0005	20	10	-	162
01930250	DIGICO 505 MI	12,5	0.5	0,001	0.00005	4	2	-	150
01930255	DIGICO 505 MIP, protected	12,5	0.5	0,001	0.00005	4	2	IP62	150

- Resolution 0,01 mm
= ± 0,25 mm Resolution
0,001 mm =
± 0,025 mm
- 6-decade LC display
field plus minus sign
- Digit size 10 x 5 mm
(H x L)
- Combined analogue
and numerical
display
- Glass scale with in-
cremental divisions,
capacitive
- Conversion mm/in
- Measuring force:
< 2 N
- ≤ 2 m/s
- Full-metal housing
with front face in
polyamide. Stainless
steel plunger.
M2,5 mounting
thread for mea-
suring insert.
- RS232,
opto-coupled
- 3V lithium battery,
type CR2032
- 1 year to 2 years
- EN 50081-1
EN 50082-1
- Transport case with
1 lithium battery
01961000
- Inspection report
with eclaration of
conformity

TESA DIGICO 600

- Measuring modes ABS/REL.
- Dual LC Display.
- Display rotation through 270°. Same goes for the key functions.
- Mechanical tolerance marks.
- Graphical display of tolerance limits.

Measuring functions and modes

ON – Auto OFF – PRESET mode – Tolerance mode – Measured value storage

- Max • Min • Max-Min (TIR) – Data output – Counting sense reversal – Keypad lock – Metric/Inch units – Full RESET.

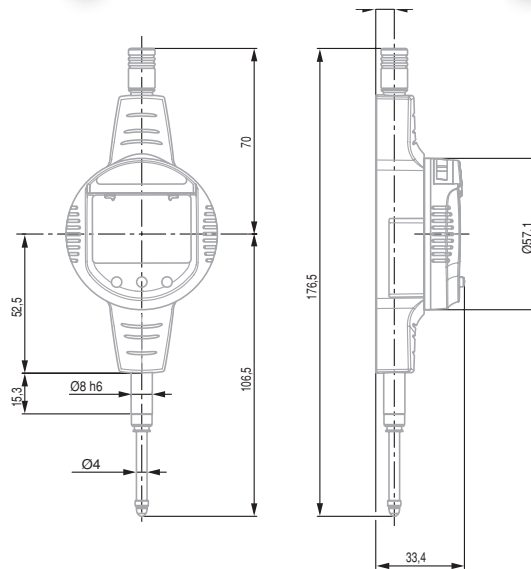

No	=							
01930256	DIGICO 605 MI	12,5	0,5	0,001	0.00005	4	2	150
01930257	DIGICO 610 MI	25	1	0,001	0.00005	5	2	162



TESA DIGICO 705

For use with 2-point contact bore gauges. Allows setting of the dial gauge to the smallest setting ring value.

- Same functions as DIGICO 600.



- Resolution to 0,01 mm = ± 0,25 mm
Resolution 0,001 mm = ± 0,025 mm
- 6-decade LC display field, plus minus sign
- Digit size 10 x 5 mm (H x L)
- Combined analogue and numerical display
- Glass scale with incremental divisions, capacitive
- Conversion mm/in
- Measuring force < 2 N
- ≤ 2 m/s
- Full-metal housing with front face in polyamide. Stainless steel plunger, M2,5 mounting thread for the measuring insert.
- RS232, opto-coupled
- 3V lithium battery, type CR2032
- 1 to 2 years
- EN 50081-1 EN 50082-1
- Transport case with 1 lithium battery 01961000
- Inspection report with declaration of conformity

01930258	DIGICO 705 MI	12,5	0.5	0,001	0.00005	4	2	150

Accessories for TESA DIGICO 200 – 700

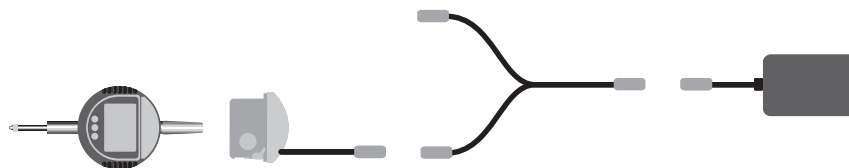

01962002		External power supply
01961000		Lithium battery, 3V, CR2032
04761054		Battery charger 100 ÷ 200 VAC / 50 ÷ 60 Hz, 6,6 Vdc, 750 mAh supplied without power cable
04761055		Cable EU for charger 0471054
04761056		Power cable US for charger 0471054

- Measuring inserts, see chapter "Measuring inserts for dial gauges, axial probes and other hand tools".
- Backs and retraction devices, see chapter "Devices for plunger retraction" and "Backs for Dial Gauges".
- Connectivity, see corresponding chapter.

- According to selected tolerances
- 30,4 mm (DIGICO 1) or 60,4 mm (DIGICO 2)
- 40 mm scale length
- According to selected tolerances
- 6 decades plus minus sign
- 9 x 4,5 mm digit size (H x W)
- LC display with backlight, with 25 divisions
- Incremental glass scale
- Metric/inch conversion
- DIGICO 1: 2 µm
DIGICO 2: 3 µm
- 1 µm
- 1 µm
- DIGICO 1: max. 1 m/s
DIGICO 2: max. 2 m/s
- Plunger guided on a plain bearing M2,5 mounting thread for measuring insert.
- RS232
- 3,6 V lithium battery or mains adapter
- ≈ 1000 h with lithium battery
- 0,002%/°C
- DIGICO case in standard execution: IP54 (IEC 60529)
- 290 g (DIGICO 1)
310 g (DIGICO 2)
- Moved mass through the plunger:
28 g (DIGICO 1)
27 g (DIGICO 2)
- Supplied in transport packing with 1 lithium battery
- 01960007
- 1 lift lever 01960005
- Inspection report with a declaration of conformity

TESA DIGICO 1 / 2

These two indicators are remarkable for their multiple simple functions, long measuring travel and high accuracy.

- Analogue/digital display combined with the possibility of orienting the analogue display in different positions.
- Zero setting at any point within the measuring span.
- Data input via the keypad.
- Counting direction reversible.
- Entry of limit values for classification through displayed symbols. Additional green, red or amber coloured background whenever the instrument is connected to mains.
- Storage of measured values through the functions: "Maximum value", "Minimum value" or "Maximum value minus minimum value".

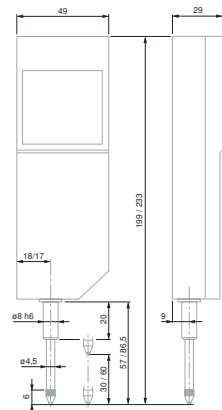

No	=				
		mm	in	mm	in
01930000	DIGICO 1	30	1.18	0,001	0.00005
01930001	DIGICO 2	60	3.36	0,001	0.00005
OPTIONAL ACCESSORIES:					
04761037	Mains adaptor 230V for DIGICO 1 or 2				
04761057	Mains adaptor 110V for DIGICO 1 or 2				
01960007	3.5 V lithium battery, LR6, AA				
01960005	Bottom mounted lift lever				
04768000	Hand switch for manually triggering data transfer.				
	Jack plug connector, 1,8 m				
	- TESA SPC PRINTER printer				
	- TESATRONIC TT display units				

Force de mesure		
	DIGICO 1	DIGICO 2
Measuring force* close to measuring plunger stop		
- Bottom	0.85 N ± 0.15 N	0.90 N ± 0.20 N
- Top	1.10 N ± 0.20 N	1.45 N ± 0.25 N
Hysteresis*	0.10 N	0.15 N

* Valid with indicator in vertical position, measuring plunger oriented downwards and in static measurement.



TESA DIGICO 12

Designed to operate in a rugged environment, resistant to spray of liquids (IP65) – 44 mm dial diameter – Provides the advantages of mechanical precision with digital reading

TESA DIGICO 12 – Standard

- 44 mm dial casing diameter.
- Resistant against cutting oils and coolants (IP65).
- RS232 SIMPLEX data output combined with external power supply.
- Inductive measuring system, patented.
- Choice between absolute "ABS" and relative "REL" measuring modes.
- Digital display.
- Setting of PRESET value (± 130 mm).
- Inverse measuring direction.
- Direct conversion of metric/inch units.
- Automatic shutdown.

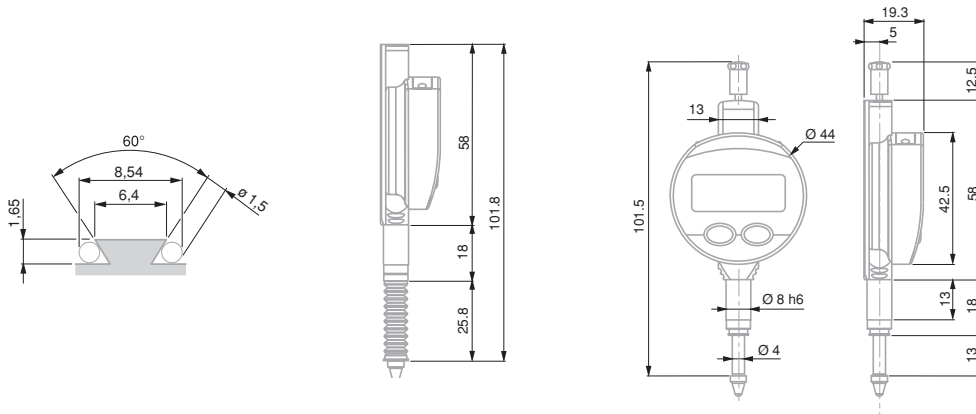

- 5-digit LC display + sign
- Digit height 6 mm
- 20 μ m
- Repeatability: 5 μ m
- 0,5 to 0,9 (\pm 0,15) N
- Max. 2 m/sec
- Number of measurements per second: 7
- Zero setting of display
- RS232
- 3 V lithium battery, type CR 3032
- Battery life > 3500 hours
- Working temperature range: 5°C to 40°C
- Protection level: IP65 (CEI 629)
- EN 61326-1
- 70 g
- Supplied in transport packing with 1 lithium battery, type CR 2032 (No 01961000)
- Inspection report with a declaration of conformity

No	mm	in	mm	in	Protection bellows	IP65
01930130	12,5	0.5	0,01	0.0005		IP65
01930132	12,5	0.5	0,001	0.00005		IP65
01930131	12,5	0.5	0,01	0.0005	With	IP65
01930133	12,5	0.5	0,001	0.00005	With	IP65

- LCD, 5 digits + sign
- Digit height: 6 mm
- Max. permissible error: 4 µm
- Repeatability limit: 2 µm
- 0,4 to 0,75 (± 0,15) N
- Max. 2 m/sec
- Number of measurements per second: 9
- Zero-setting of display
- RS232
- 3 V lithium battery, type CR 2032
- Battery life: > 4000 hours
- Working temperature range: 5°C to 40°C
- IP65 (CEI 529)
- EN 61326-1
- 70 g
- Supplied in transport packing with 1 lithium battery, type CR 2032 (No 01961000)
- Inspection report with a declaration of conformity

TESA DIGICO 12 – HP

- High precision measuring system.
- Resistant to cutting oils and coolants (IP65).
- Combined analogue/digital display.
- Analogue reading from ±0.025 to ±1.25 mm.
- NOR/MIN/MAX/MAX-MIN measuring modes.
- 44 mm dial casing diameter.
- RS 232 data output combined with external power supply.
- Inductive measuring system, patented.
- Zero-setting of display.
- Direct conversion of metric/inch units.
- Shut down: either automatic or blocked.

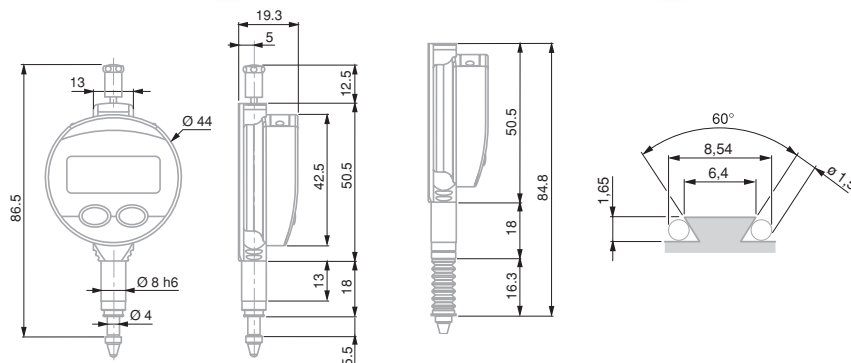

No					Protection bellows	
01930134	5	0.210	0,001	0.00005		IP65
01930135	5	0.210	0,001	0.00005	With	IP65

Accessories for TESA DIGICO 12

No	
03238013	Mounting lug
01961012	Upper lift lever
01960005	Bottom mounted lift lever
04761060	RS 232 cable with external power supply
01961000	Lithium battery, 3V, CR2032

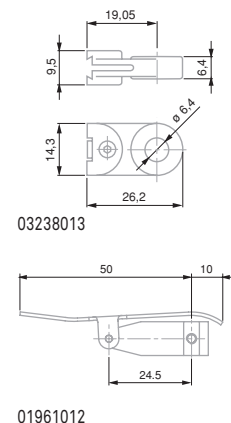

ETALON HP

High precision comparators

ETALON with short measuring travel

The ultimate in high precision.

Remarkably reliable, even when constantly used for series inspection – Specially designed for comparative measurements requiring a very low measurement uncertainty – Measures axial and radial runouts with very low hysteresis.

- Shockproof movement. Lever and gear transmission system. Long dead travel.
- Non-reflecting dial for easy readout.
- Measuring travel limited to less than one revolution of pointer. No possibility of reading errors.
- Fine adjustment with protective knob to prevent accidental displacement of the pointer.

- DIN 879-1 Dimensions according to EN ISO 463
- Full-metal dial casing. Stainless steel plunger, hardened.
- ≈ 1 N
- Measuring plunger on ball-bearings
- Adjustable tolerance markers. Coupling thread for retraction cable. M2,5 thread for measuring insert
- 1 measuring insert already mounted, steel ball tip Ø 3.175 mm. 1 retraction cable.

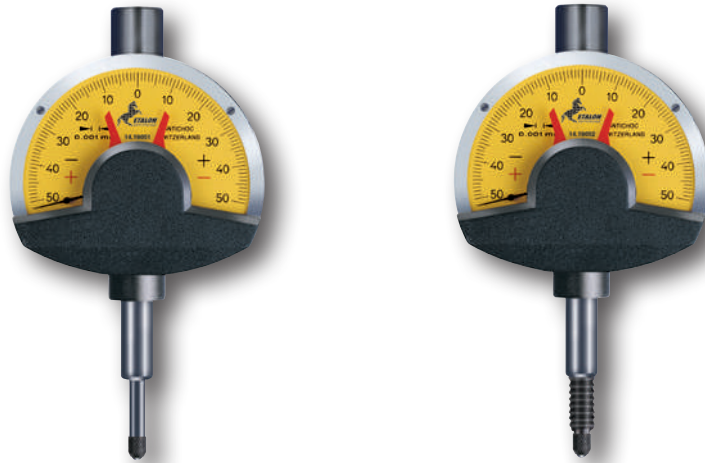

01419051	0,1	0,001	3,0	50 ÷ 0 ÷ 50	●	62	-
01419052	0,1	0,001	3,0	50 ÷ 0 ÷ 50	●	62	IP54

Accuracy

	0,001 mm
	Max. perm. errors in one direction throughout the measuring range, G_e
	1 μ m
	over any selected local range including 10 scale divisions, G_t
	0,7 μ m
	in both measuring directions throughout the total measuring range, G_{ges}
	1,2 μ m
	Repeatability limit, r_w
	0,5 μ m
	Max. hysteresis, f_u
	0,5 μ m

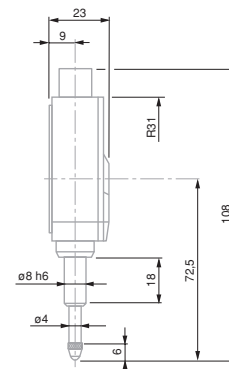

- EN ISO 463
Factory standard
- Rotating dial. With
or without dial lock
for standard models
- Full-metal dial
casing. Mounting
shank and plunger
in hardened
stainless steel
- With or without
shockproof
mechanism
- Adjustable tolerance
markers. Thread
M2,5 for measuring
insert
- Measuring insert
with 3 mm dia. ball
tip already mounted
- Inspection report
with a declaration of
conformity

DIAL GAUGES – PREMIUM QUALITY

The TOP quality of our dial gauges guarantee the use of the best and most wear-resistant materials in order to ensure that the most demanding metrological criteria are respected along with a product life that exceeds all other dial gauges

Dial Ø 40 mm – Reading 0,01 mm

Precision dial gauges

These precision dial gauges combine excellent metrological properties with extra-long life.

- Smooth and regular travel, entirely jewel-mounted movement.
- Full-metal dial casing and bezel.
- Shockproof mechanism in both directions of plunger movement.
- Non-reflecting dial.



01410210

353

353E

No	=								
		mm	mm	mm	mm				
01410210	TESA YR	5	5,4	0,01	0,5	0 ÷ 25 ÷ 50	●	●	
01416013	MERCER X185-1	5	5,4	0,01	0,5	0 ÷ 25 ÷ 0	-	●	
01416014	MERCER 186-1	5	5,4	0,01	0,5	0 ÷ 25 ÷ 50	-	●	
01412010	TESA YE	5	5,4	0,01	0,5	0 ÷ 25 ÷ 50	-	-	
353	COMPAC 353	5	5,4	0,01	0,5	0 ÷ 25 ÷ 50	●	-	
353E	COMPAC 353E IP54	5	5,4	0,01	0,5	0 ÷ 25 ÷ 50	●	-	IP54

Permissible limits of a metrological characteristic (MPE/MPL)

		0,01 mm
	Deviation span	12 µm
	Deviation span within partial measuring span 0,10 mm	6 µm
	Total deviation span	14 µm
	Repeatability limit	3 µm
	Max. hysteresis	3 µm
	Measuring force	= 1,4 N
	- IP54 model	= 2 N

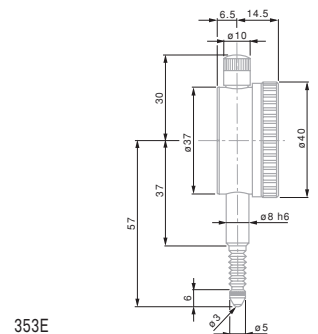
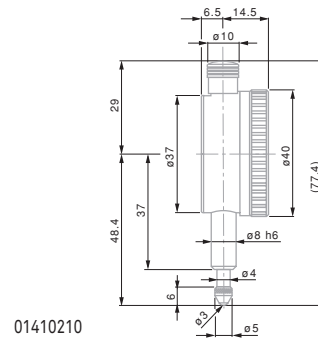

Dial Ø 57 and 58 mm – Reading 0,01 mm

Precision dial gauges



01410610



512K



532E



01416021

- EN ISO 463
Factory standard
- Rotating dial. With or without dial lock for standard models
- Full-metal dial casing. Mounting shank and plunger in hardened stainless steel
- With or without anti-shock mechanism
- Adjustable tolerance markers. Thread M2,5 for measuring insert
- Measuring insert with Ø 3 mm ball tip already mounted
- Inspection report with declaration of conformity

No	=							
		mm	mm	mm	mm			
01410610	TESA YR	10	10,5	0,01	1	0 ÷ 50 ÷ 100	●	●
01410611	TESA YR	10	10,5	0,01	1	0 ÷ 50 ÷ 0	●	●
01412310	TESA YE	10	10,5	0,01	1	0 ÷ 50 ÷ 100	-	-
01416021	MERCER 251-1	10	10,5	0,01	1	0 ÷ 50 ÷ 100	-	●
512K	COMPAC 512K	10	10,5	0,01	1	0 ÷ 50 ÷ 100	-	-
532	COMPAC 532	10	10,5	0,01	1	0 ÷ 50 ÷ 100	●	-
532E	COMPAC 532E IP54	10	10,5	0,01	1	0 ÷ 50 ÷ 100	●	- IP54
533S	COMPAC 533S limited travel	± 0.5	4	0,01	1,27	50 ÷ 0 ÷ 50	●	-

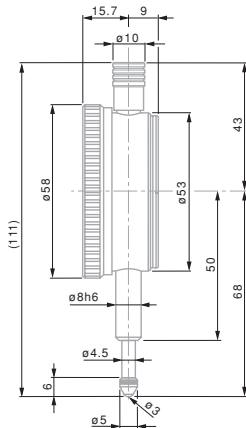

512K

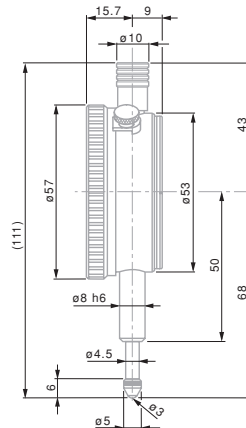

01410610 - 01410611

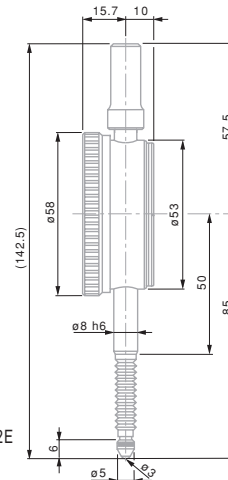

532E

Permissible limits of a metrological characteristic (MPE/MPL)

	± 0,5	10 mm
Deviation span	7 µm	15 µm
Deviation span within the selected local measuring span 0.10 mm	5 µm	8 µm
Total deviation span	9 µm	17 µm
Repeatability limit	3 µm	3 µm
Max. hysteresis	3 µm	3 µm
Measuring force – Models IP54	= 1 N –	≤ 1,5 N ≤ 2,2 N

Dial Ø 58 mm – Reading 0,01 mm – Long travel

Long range precision dial gauges

- EN ISO 463
Factory standard
- Rotating dial. With or without dial lock.
- Full-metal dial casing. Mounting shank and plunger in hardened stainless steel
- Adjustable tolerance markers. Thread M2,5 for measuring insert
- Measuring insert with 3 mm ball tip already mounted
- Inspection report with declaration of conformity



712

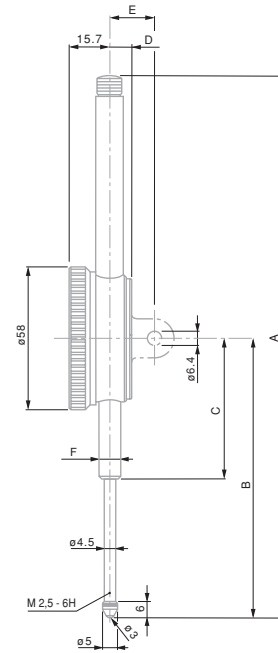

No	=									
		mm	mm	mm	mm	mm				
712	COMPAC 712	30	30,5	0,01	1	0 ÷ 50 ÷ 100	●	–	–	58
722	COMPAC 722	50	50,5	0,01	1	0 ÷ 50 ÷ 100	●	–	–	58
732	COMPAC 732	100	100,5	0,01	1	0 ÷ 50 ÷ 100	●	–	–	58

Dimensions

mm	30 mm	50 mm	100 mm
A	148	228	390
B	88	117,2	211,6
C	50	60	103,6
D	10	9	9
E	20	19	19
F	Ø 8h6	Ø 8h6	Ø 8h6

Permissible limits of a metrological characteristic (MPE/MPL)

	30 mm	50 mm	100 mm
Deviation span	20 µm	25 µm	30 µm
Total deviation span	25 µm	30 µm	35 µm
Repeatability limit	3 µm	3 µm	3 µm
Max. hysteresis	5 µm	5 µm	8 µm
Measuring force	≤ 2,2 N	≤ 2,5 N	≤ 3,2 N



Dial Ø 82 mm – Reading 0,01 mm
Precision dial gauges



01410910

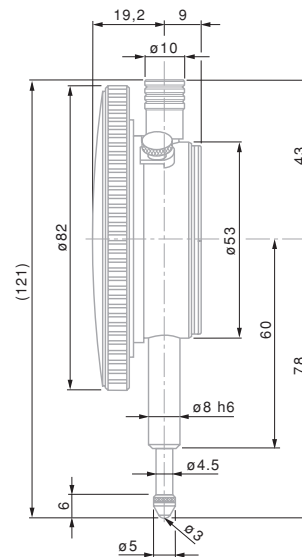

01410910

- EN ISO 463
Factory Standard
- Rotating dial. With
or without dial lock
- Full-metal dial cas-
ing. Stainless steel
fixing shank and
plunger, hardened
- High performance
shock-proof system
in the 2 directions
- M2,5 thread for
measuring insert
- Measuring insert
with Ø 3 mm ball tip,
already mounted
- Inspection report
with declaration of
conformity



01410910	10	10,5	0,01	0,1	0 ÷ 50 ÷ 100	●	●

Permissible limits of a metrological characteristic (MPE/MPL)

		10 mm
	Deviation span	15 µm
	Deviation span within partial measuring span of 0,10 mm	8 µm
	Total deviation span	17 µm
	Repeatability limit	3 µm
	Max. hysteresis	3 µm
	Measuring force	≤ 1,4 N

- EN ISO 463
Factory standard
- Rotating dial
- Full-metal casing.
Fixing shank and
plunger in hardened
stainless steel
- Adjustable tolerance
markers. Thread
M2,5 for measuring
insert
- Measuring insert
with 0.3 mm ball tip
already mounted
- Inspection report
with declaration of
conformity

Dial Ø 40 mm – Reading 0,002 mm

Precision dial gauges

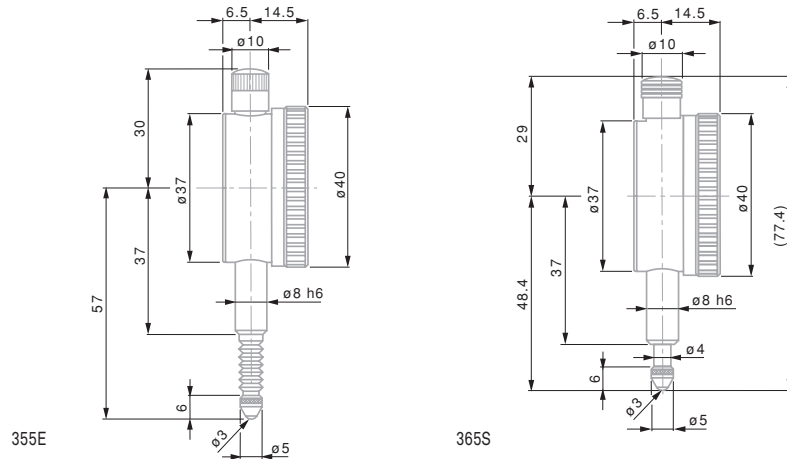

	mm	mm	mm	mm						
355	3	3,3	0,002	0,2	0 ÷ 10 ÷ 20	●	-	40		
355E	3	3,3	0,002	0,2	0 ÷ 10 ÷ 20	●	-	40	IP 54	
365S	±0,08	1,5	0,002	0,2	8 ÷ 0 ÷ 8	●	-	40		

Permissible limits of a metrological characteristic (MPE/MPL)

	±0,08 mm	3 mm
	2 µm	10 µm
Deviation span within the selected local measuring span 0,10 mm	2 µm	6 µm
Total deviation span	4 µm	12 µm
	1 µm	1,5 µm
	1 µm	2 µm
	≤ 1,4 N - Model IP54	≤ 1,4 N ≤ 1,7 N



Dial Ø 58 mm – Reading 0,002 mm

Precision dial gauges

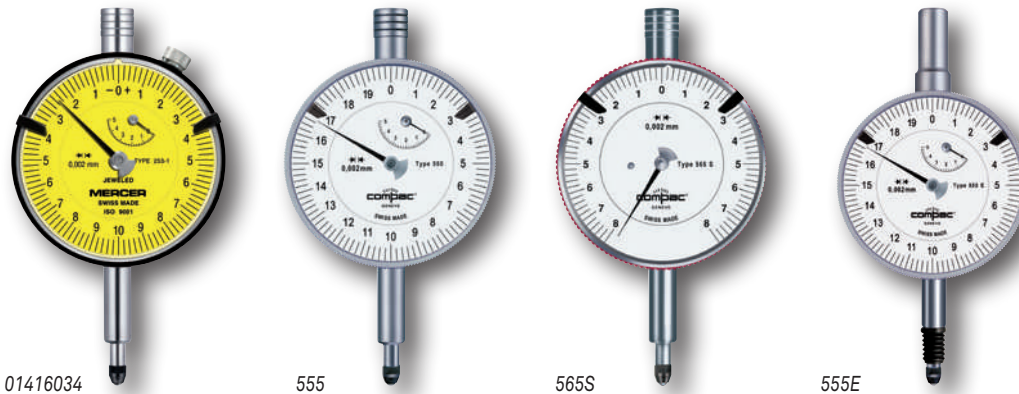

01416034

555

565S

555E

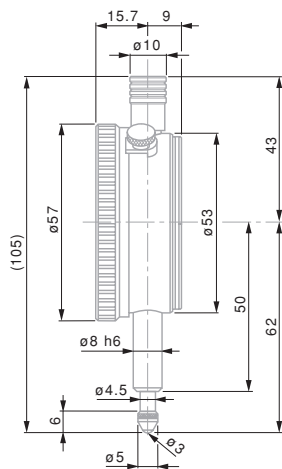

01416034

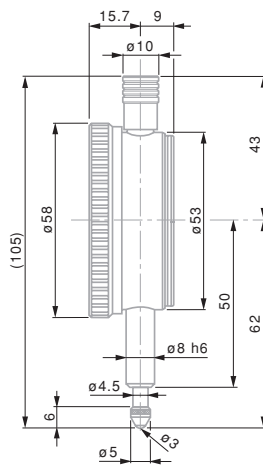

555

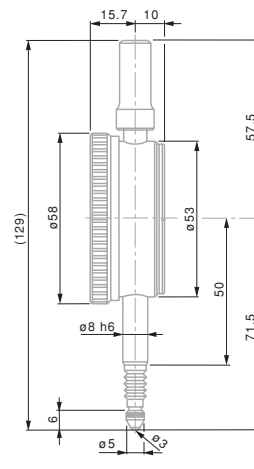

555E

- EN ISO 463
Factory standard
- Rotating dial. With
or without dial lock.
- Full-metal dial
casing. Mounting
shank and plunger
in hardened stain-
less steel
- Adjustable tolerance
markers. Thread
M2,5 for measuring
insert
- Measuring insert
with 3 mm ball tip
already mounted
- Inspection report
with declaration of
conformity

No	Symbol	mm	mm	mm	mm	mm	mm	mm	mm	mm
01416034	MERCER 253-1	5	5,3	0,002	0,2	0 ÷ 10 ÷ 0	-	●	58	-
555	COMPAC 555	5	5,3	0,002	0,2	0 ÷ 10 ÷ 20	●	-	58	-
555E	COMPAC 555E IP54	5	5,3	0,002	0,2	0 ÷ 10 ÷ 20	●	-	58	IP 54
565S	COMPAC 565S limited travel	±0,08	3,3	0,002	0,2	8 ÷ 0 ÷ 8	●	-	58	-

Permissible limits of a metrological characteristic (MPE/MPL)

	Symbol	mm	mm
		±0,08 mm	5 mm
	Deviation span	4 µm	12 µm
	Total deviation span	4 µm	14 µm
	Repeatability limit	1 µm	2 µm
	Max. hysteresis	1 µm	2 µm
	Measuring force – Model IP54	≤ 1,5 N –	≤ 1,5 N ≤ 1,7 N

- EN ISO 463
Factory standard
- Cardboard box
- Full-metal dial casing. Mounting shank and plunger in hardened stainless steel
- With shock-proof mechanism, in both directions
- Adjustable tolerance markers. Thread M2,5 for measuring insert
- Measuring insert with 3 mm steel ball tip already mounted
- Inspection report with declaration of conformity

Dial Ø 40 mm – Reading 0,001 mm

Precision dial gauges



01410010



01410120

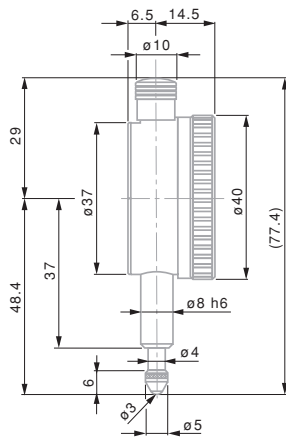

01410010

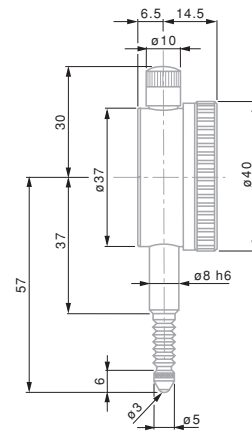

01410120

No	TESA	mm	mm	mm	mm	mm	mm	mm	mm	mm	mm
01410010	TESA YR	1	1,5	0,001	0,1	40	0 ÷ 50 ÷ 100	●	●	40	-
01412510	TESA YE	1	1,5	0,001	0,1	40	0 ÷ 50 ÷ 100	●	-	40	-
01410120	TESA YR IP54	1	1,5	0,001	0,1	40	0 ÷ 50 ÷ 100	●	-	40	IP 54
367	COMPAC 367	1	1,5	0,001	0,1	40	0 ÷ 5 ÷ 10	●	-	40	-
367E	COMPAC 367E IP54	1	1,5	0,001	0,1	40	0 ÷ 5 ÷ 10	●	-	40	IP 54

Permissible limits of a metrological characteristic (MPE/MPL)

		1 mm
	Deviation span	4 µm
	Deviation span within the selected local measuring span 0,10 mm	4 µm
	Total deviation span	5 µm
	Repeatability limit	1 µm
	Max. hysteresis	1 µm
	Measuring force - Model IP54	≤ 1,7 N ≤ 2 N



Dial Ø 58 mm – Reading 0,001 mm

Precision dial gauges



01412511



556



01412611

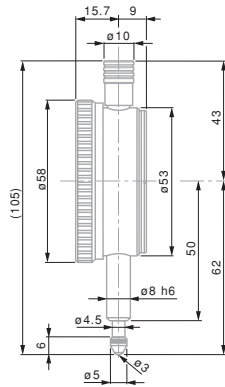

567

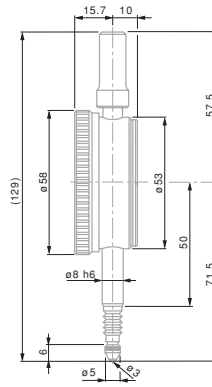

556E

- EN ISO 463
Factory standard
- Rotating dial
- Full-metal dial casing. Mounting shank and plunger in hardened stainless steel
- Effective anti-shock in the 2 directions
- Adjustable tolerance markers. Thread M2,5 for measuring insert
- Measuring insert with 3 mm Ø ball tip, already mounted
- Inspection report with declaration of conformity

No	TESA	mm	mm	mm	mm	mm	mm	mm	mm	mm	mm
01412511	TESA YE	1	1,5	0,001	0,1	58	0 ÷ 50 ÷ 100	●	-		
01412611	TESA YE	5	5,3	0,001	0,2	58	0 ÷ 100 ÷ 200	●	-		
556	COMPAC 556	5	5,3	0,001	0,2	58	0 ÷ 10 ÷ 20	●	-		
567	COMPAC 567	1	3,3	0,001	0,1	58	0 ÷ 5 ÷ 10	●	-		
556E	COMPAC 556E IP54	5	5,3	0,001	0,2	58	0 ÷ 10 ÷ 20	●	-		IP54
01412711	TESA YE IP54	1	1,5	0,001	0,1	58	0 ÷ 50 ÷ 100	●	-		IP54
01410520	TESA YR IP54	1	3,3	0,001	0,1	58	0 ÷ 50 ÷ 100	●	-		IP54

Permissible limits of a metrological characteristic (MPE/MPL)

	1 mm	5 mm
Deviation span	4 µm	12 µm
Deviation span within the selected local measuring span 0,10 mm	4 µm	-
Total deviation span	5 µm	14 µm
Repeatability limit	1 µm	2 µm
Max. hysteresis	1 µm	2 µm
Measuring force - Models IP54	≤ 1,7 N -	≤ 1,5 N ≤ 1,7 N

- EN ISO 463
Factory standard
- Rotating dial. With
or without dial lock.
- Full-metal dial casing. Stainless steel
fixing shank and
plunger, hardened
- High performance
anti-shock system
in both directions
- M2,5 thread for
measuring inserts
- Measuring insert
with Ø 3 mm ball
tip, already mounted
- Inspection report
with a declaration of
conformity

Dial Ø 82 mm – Reading 0,001 mm

Precision dial gauges



556G

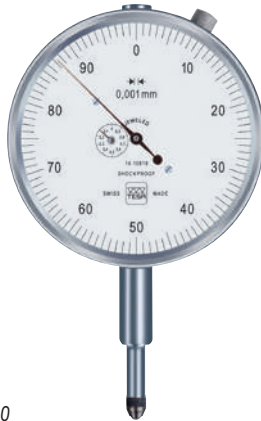

01410810

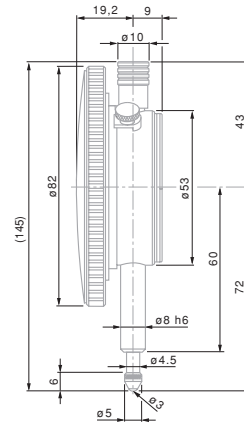

01410810

			mm	mm	mm	mm				
01410810	TESA YR	1	3,3	0,001	0,1	0 ÷ 50 ÷ 100	●	●		82
556G	COMPAC 556G	5	5,3	0,001	0,2	0 ÷ 10 ÷ 20	●	–		82

Permissible limits in a metrological characteristic (MPE/MPL)

	1 mm	5 mm
Deviation span	4 µm	12 µm
Deviation span within partial measuring span of 0,10 mm	4 µm	–
Total deviation span	5 µm	14 µm
Repeatability limit	1 µm	2 µm
Max. hysteresis	1 µm	2 µm
Measuring force	≤ 1,7 N	≤ 1,5 N



STANDARD DIAL GAUGES

The Standard product line offers a range of heavy duty and competitively priced dial gauges.

Dial Ø 40 / 58 – Reading 0,1 mm

Precision dial gauges

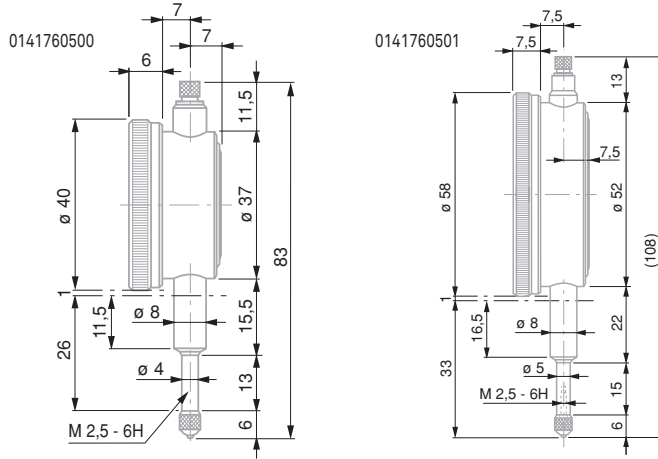

0141760500
0141760501

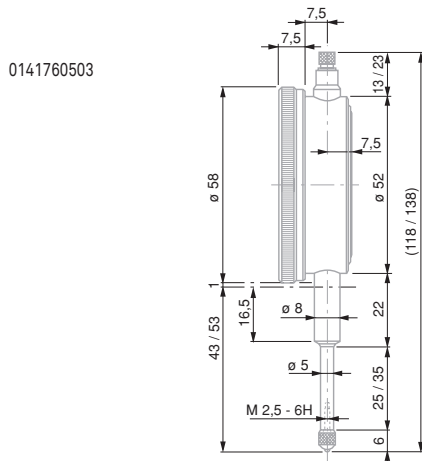

0141760503



- EN ISO 463
Factory standard
- Rotating dial
- Full-metal casing.
Mounting shank and
plunger in hardened
stainless steel
- Without anti-shock
mechanism
- Thread M2,5 for
measuring insert
- Measuring insert
with 3,175 mm
Ø ball tip already
mounted

	mm	mm	mm	mm	mm	mm	mm	N	mm
0141760500	10	10,5	0,1	10	0 ÷ 5 ÷ 10	-	≤ 1,0	40	
0141760501	10	10,5	0,1	10	0 ÷ 5 ÷ 10	-	≤ 1,0	58	
0141760503	30	30,5	0,1	10	0 ÷ 5 ÷ 10	-	≤ 1,5	58	

Permissible limits of a metrological characteristic (MPE/MPL)

	0,1 mm
Deviation span	40 µm
Deviation span within partial measuring span of 0.1 mm	25 µm
Total deviation error	55 µm
Repeatability limit	15 µm
Max. hysteresis	15 µm

Dial Ø 58 mm – Reading 0,01 mm – Long travel
Long travel precision dial gauges



0141760635



0141760624



0141761213



0141760661



0141760651

0141760631
0141760635
0141760636

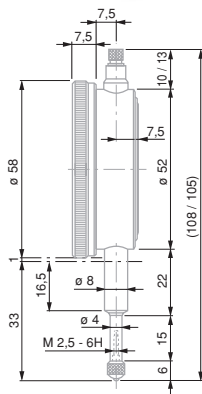

0141761213

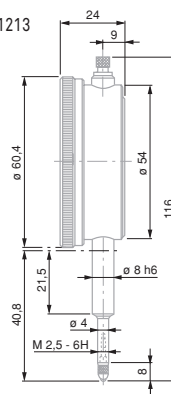

0141760624

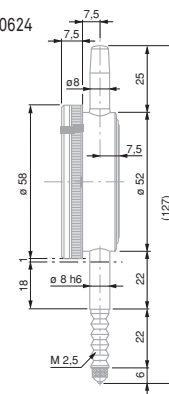

0141760651
0141760653

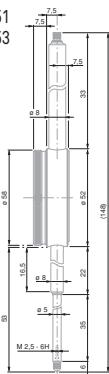

0141760661

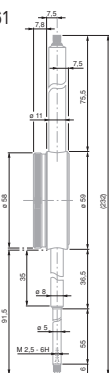

- EN ISO 463
Factory standard
- Rotating dial
- Full-metal casing.
Mounting shank and plunger in hardened stainless steel
- With or without anti-shock mechanism
- Adjustable tolerance markers. Thread M2,5 for measuring insert
- Accuracy: see table for max. deviations. If measurements are carried out with a downward plunger, the same must be mechanically coupled to the measuring point to eliminate all hysteresis
- Measuring insert with Ø 3,175 mm steel ball tip, already mounted. Exceptions: Model numbers 0141760631 / 0141761213 with ruby ball tips.

No	≡																																																																																																																																																																																																																																																																																																																																																																																																																																																																																																																																																																																																																																																																																																																					
----	---	--	--	--	--	--	--	--	--	--	--	--	--	--	--	--	--	--	--	--	--	--	--	--	--	--	--	--	--	--	--	--	--	--	--	--	--	--	--	--	--	--	--	--	--	--	--	--	--	--	--	--	--	--	--	--	--	--	--	--	--	--	--	--	--	--	--	--	--	--	--	--	--	--	--	--	--	--	--	--	--	--	--	--	--	--	--	--	--	--	--	--	--	--	--	--	--	--	--	--	--	--	--	--	--	--	--	--	--	--	--	--	--	--	--	--	--	--	--	--	--	--	--	--	--	--	--	--	--	--	--	--	--	--	--	--	--	--	--	--	--	--	--	--	--	--	--	--	--	--	--	--	--	--	--	--	--	--	--	--	--	--	--	--	--	--	--	--	--	--	--	--	--	--	--	--	--	--	--	--	--	--	--	--	--	--	--	--	--	--	--	--	--	--	--	--	--	--	--	--	--	--	--	--	--	--	--	--	--	--	--	--	--	--	--	--	--	--	--	--	--	--	--	--	--	--	--	--	--	--	--	--	--	--	--	--	--	--	--	--	--	--	--	--	--	--	--	--	--	--	--	--	--	--	--	--	--	--	--	--	--	--	--	--	--	--	--	--	--	--	--	--	--	--	--	--	--	--	--	--	--	--	--	--	--	--	--	--	--	--	--	--	--	--	--	--	--	--	--	--	--	--	--	--	--	--	--	--	--	--	--	--	--	--	--	--	--	--	--	--	--	--	--	--	--	--	--	--	--	--	--	--	--	--	--	--	--	--	--	--	--	--	--	--	--	--	--	--	--	--	--	--	--	--	--	--	--	--	--	--	--	--	--	--	--	--	--	--	--	--	--	--	--	--	--	--	--	--	--	--	--	--	--	--	--	--	--	--	--	--	--	--	--	--	--	--	--	--	--	--	--	--	--	--	--	--	--	--	--	--	--	--	--	--	--	--	--	--	--	--	--	--	--	--	--	--	--	--	--	--	--	--	--	--	--	--	--	--	--	--	--	--	--	--	--	--	--	--	--	--	--	--	--	--	--	--	--	--	--	--	--	--	--	--	--	--	--	--	--	--	--	--	--	--	--	--	--	--	--	--	--	--	--	--	--	--	--	--	--	--	--	--	--	--	--	--	--	--	--	--	--	--	--	--	--	--	--	--	--	--	--	--	--	--	--	--	--	--	--	--	--	--	--	--	--	--	--	--	--	--	--	--	--	--	--	--	--	--	--	--	--	--	--	--	--	--	--	--	--	--	--	--	--	--	--	--	--	--	--	--	--	--	--	--	--	--	--	--	--	--	--	--	--	--	--	--	--	--	--	--	--	--	--	--	--	--	--	--	--	--	--	--	--	--	--	--	--	--	--	--	--	--	--	--	--	--	--	--	--	--	--	--	--	--	--	--	--	--	--	--	--	--	--	--	--	--	--	--	--	--	--	--	--	--	--	--	--	--	--	--	--	--	--	--	--	--	--	--	--	--	--	--	--	--	--	--	--	--	--	--	--	--	--	--	--	--	--	--	--	--	--	--	--	--	--	--	--	--	--	--	--	--	--	--	--	--	--	--	--	--	--	--	--	--

- EN ISO 463
Factory standard
- Rotating dial
- Full-metal casing.
Mounting shank and plunger in hardened stainless steel
- With or without anti-shock mechanism
- Adjustable tolerance markers. Thread M2,5 for measuring insert
- Measuring insert with $\varnothing 3,175$ mm steel ball tip, already mounted

Dial $\varnothing 58$ mm – Reading 0,01 mm – Standard and long travel

Precision dial gauges

Standard and long travel models



01419048

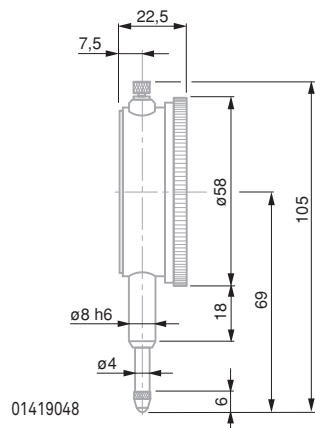

01419048

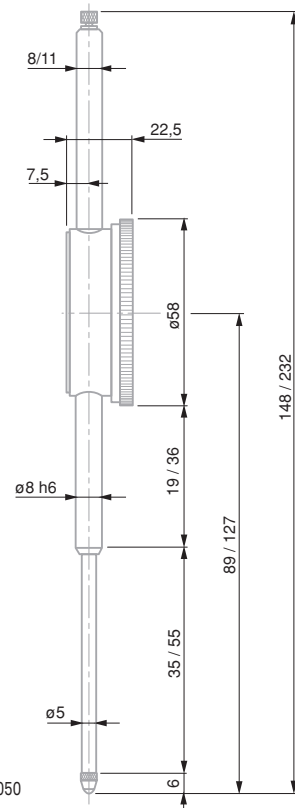

01419050

		mm	mm	mm		N	
01419048		10	0,01	1	0 ÷ 50 ÷ 100	–	≈1
01419050		50	0,01	1	0 ÷ 50 ÷ 100	●	1,5 ÷ 2

For magnetic or central lug backs, see backs for ROCH and ETALON dial gauges

Permissible limits for a metrological characteristic (MPE/MPL)

	mm	10	50
	Deviation span	μ m	15
	Deviation span within selected partial measuring span 0,10 mm	μ m	8
	Repeatability Limit	μ m	3



DIAL GAUGES – ANALOGUE WITH BACK MOUNTED PLUNGER

Mechanical dial gauges with back mounted plungers differentiate by their concept of presenting a display which is perpendicular to the movement of the measuring stem.

Dial Ø 40 mm – Reading 0,01 or 0,002 mm

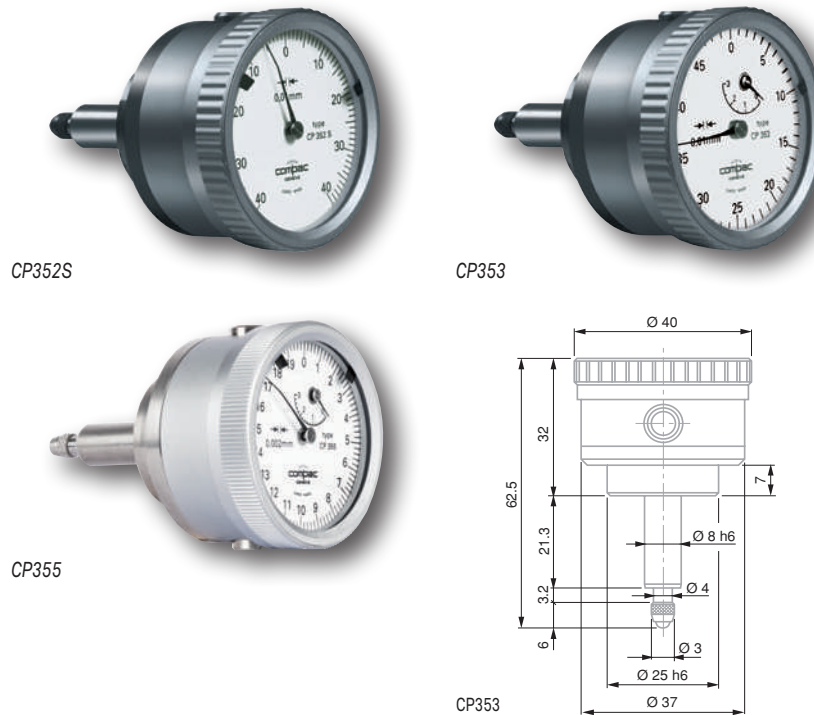

- EN ISO 463
Factory standard
- Rotating dial
- Full-metal casing. Mounting shank and plunger in hardened stainless steel
- With anti-shock mechanism
- Adjustable tolerance markers. Thread M2,5 for measuring insert. Fastening with sleeve Ø 8h6 and 25h6
- Measuring insert with Ø 3 mm steel ball tip, already mounted
- Inspection report with declaration of conformity

No	=									
CP 353	COMPAC CP353	3	3,2	0,01	14	3	3	0,5	0 ÷ 25 ÷ 50	0,9
CP 355	COMPAC CP355	3	3,2	0,002	14	2	2,5	0,2	0 ÷ 10 ÷ 20	0,9
CP 352S	COMPAC CP352S with limited travel	± 0,4	3,2	0,01	9	3	3	(1)	40 ÷ 0 ÷ 40	0,9

S: Limited range of indication, restricted reading.
The needle makes less than one revolution of the dial, all reading errors due to revolution counter are eliminated.

Dial Ø 40 mm – Reading 0,01 mm

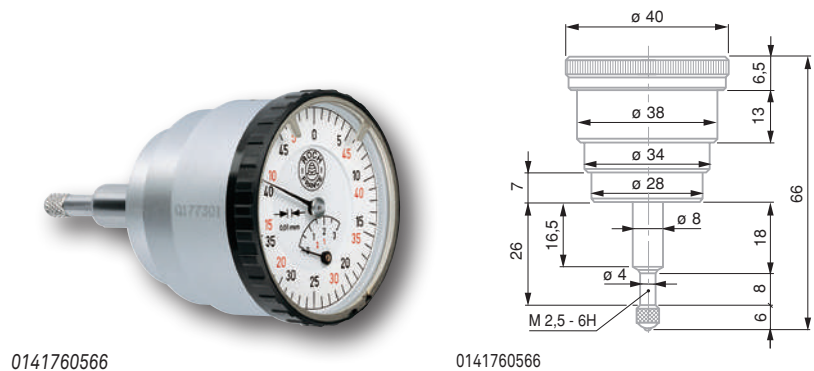

- EN ISO 463
Factory standard
- Rotating dial
- Full-metal casing. Mounting shank and plunger in hardened stainless steel
- Adjustable tolerance markers. Thread M2,5 for measuring insert.
- Measuring insert with Ø 3,175 mm steel ball tip, already mounted

No	=									
0141760566	ROCH	3	3,5	0,01	15	5	15	0,5	0 ÷ 25 ÷ 50	≤ 1,2

With extra reverse numbering in red

INSERTS FOR DIAL GAUGES, AXIAL PROBES, ETC. - EXECUTION WITH M2,5 THREAD

Spherical measuring inserts, standard.

No	
03510001	Steel
03510002	Carbide
03560001	Sapphire

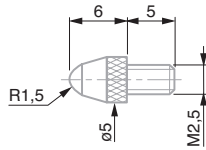

Spherical measuring insert, short

No	
03560007	Carbide

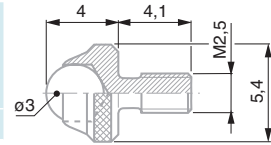

Spherical measuring inserts, long

No	
03560019	Steel
03560020	Carbide
03560021	Ruby

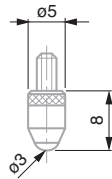

Spherical measuring inserts, R = 0,5 mm.

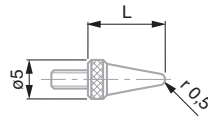

No			L mm
03560035	Steel		5
03560036	Steel		10
03560037	Steel		15
03560038	Steel		20
03560039	Steel		30
03560040	Steel		40

Spherical measuring inserts

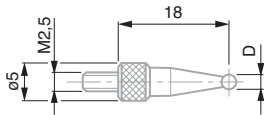

No			D, mm
03560051	Carbide		1
03560052	Carbide		2
03560053	Carbide		3
03560054	Carbide		4
03560055	Carbide		5
03560056	Carbide		6
03560057	Carbide		7
03560058	Carbide		8

Spherical measuring insert with 4 interchangeable pins, R = 1,5 mm

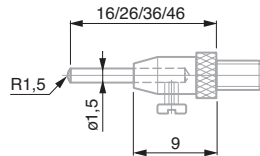

No			L, mm
03510201	Steel		16, 26, 36, 46

Spherical measuring inserts

No	
03510101	Steel
03510102	Carbide

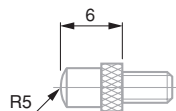

Spherical measuring inserts

No	
03560017	Steel
03560018	Carbide

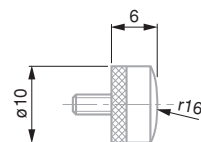

Measuring insert with offset (A)
Pointed measuring face
Lock nut for radial alignment.

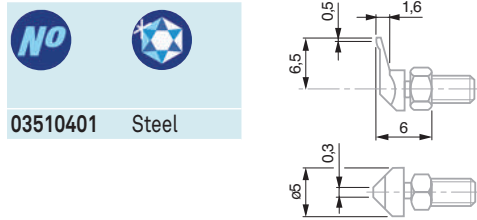

03510401 Steel

Measuring insert with offset (A)
Pointed measuring face
Lock nut for radial alignment.

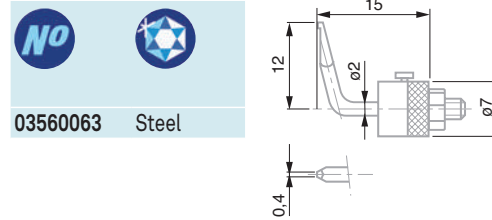

03560063 Steel

Measuring insert with needle contact point



03560030 Steel

Measuring inserts with ball-bearing rollers
Lock nut for radial alignment

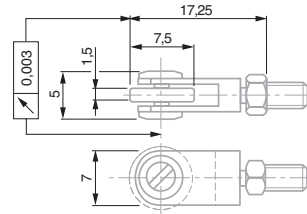

No	Shape	Material
03560010	Cylindrical	Steel
03560011	Domed	Steel

Inserts with a knife blade measuring face
Lock nut for radial alignment

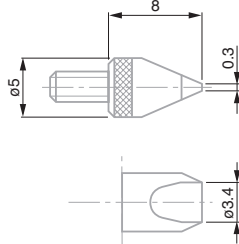

No	Material
03560024	Steel
03560025	Carbide

Inserts with a knife blade steel face
Lock nut for radial alignment

No	L, mm
03560031	5
03560032	10
03560033	15
03560034	20

Insert with a cylindrical measuring face
Lock nut for radial alignment

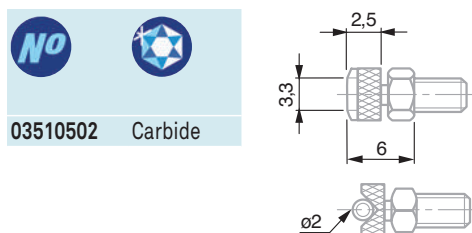

03510502 Carbide

Insert with a narrow, off-centre measuring face
Lock nut for radial alignment

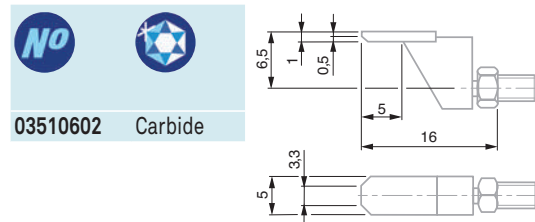

03510602 Carbide

Insert with a narrow measuring face
Parallelism adjustable
Lock nut for radial alignment



03510702 Carbide

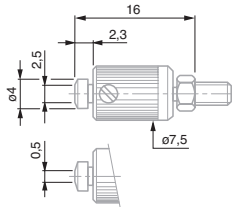

Inserts with a flat measuring face.

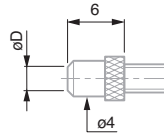

No	Length	Material
03510801	2,5	Steel
03510802	2,5	Carbide
03560022	3,4	Steel
03560023	3,4	Carbide

Insert with a flat measuring face
Parallelism adjustable
Counter-nut for radial alignment



03510902 Métal dur

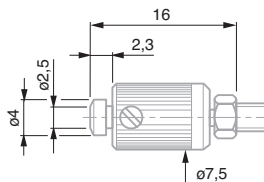

Inserts with a flat measuring face, in steel

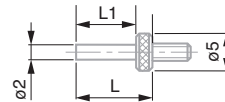

No	L, mm	L1, mm
03560026	5	2,8
03560027	10	7,8
03560028	15	12,8
03560029	20	17,8

Inserts with interchangeable pins
Flat measuring face



03560008 Steel
03560009 Carbide

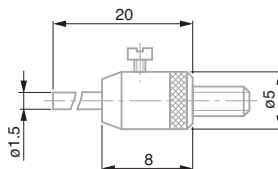

Inserts with flat measuring face

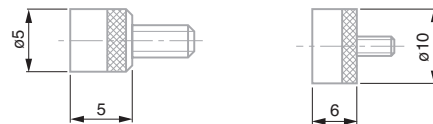

No	Length	Material
03560012	5	Steel
03560013	5	Carbide
03560014	10	Steel
03560015	10	Carbide
03560016	20	Steel

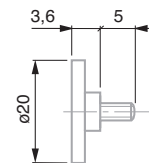

Connectors for measuring inserts

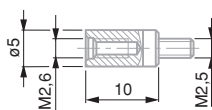

No	Outside	Inside
03560092	M2,5	M2
03560065	M3	M2,5

Extensions for measuring inserts

No	L, mm
03560042	10
03560043	15
03560044	20
03560045	25
03560046	30
03560047	35
03560048	40
03560049	45
03560050	50

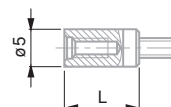

Extensions for measuring inserts.

No	L, mm
03540501	10
03540502	15
03540503	20
03540504	40

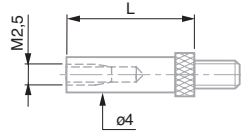

– EXECUTIONS WITH A M2 COUPLING THREAD



Spherical measuring inserts, M2 thread

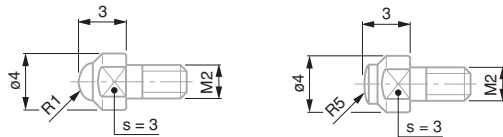

No	mm	
03510204	R 1	Carbide
03510103	R 5	Carbide

Spherical measuring inserts, R = 5 mm, M2 thread

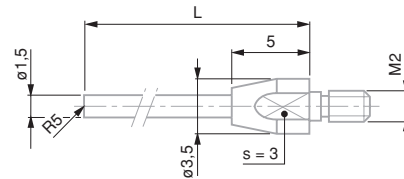

No		L, mm
03510202	Carbide	16
03510203	Carbide	26

Measuring insert with cylindrical measuring face. Lock nut for radial alignment, M2 thread

No	Carbide
03510503	Carbide

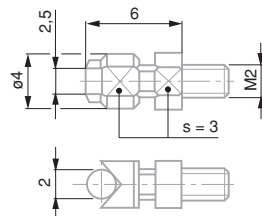

Extensions for measuring inserts, M2

No	L, mm
03540505	10
03540506	15

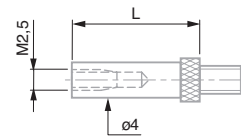

ADDITIONAL ACCESSORIES FOR DIAL GAUGES

Device for plunger retraction for mounting on the bottom stem

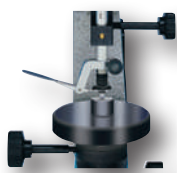

No	
Consisting of:	
03540104	- 03540101: Lever - 03540102: Washer



Device for plunger retraction for mounting on the top stem

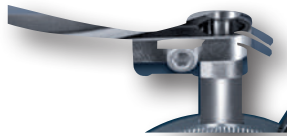

No	
mm	
03560004	Ø 40
03560005	Ø 58



Retraction lever Bottom mounted lift lever

No	=	
01960005	Bottom mounted lift lever	Contains only lifting lever



90° angle probe. For the transmission of movements of the measuring plunger. Max. travel up to 10 mm. For dial gauges of 0,01 mm

No	=	A
03560006	90° angular probe	03560012; Insert with flat measuring face, Ø 5 mm



A Matt chrome plated except for tinted model numbers 01460010, 01460011

Backs for ROCH and ETALON Dial Gauges

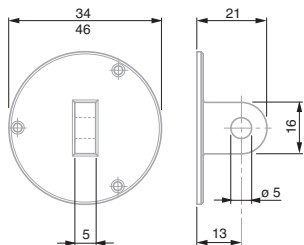

No			A
	Bezel diameter, mm	Back, mm	
01462004	40	34	Back with central lug
01462005	58, 60, 80	46	Back with central lug

Backs for dial gauges TESA YR – YE / MERCER / COMPAC / DIGICO 200-700 – Ø 40 mm dial models

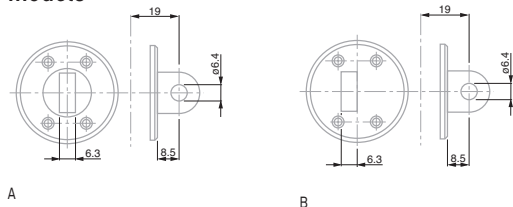

No	A
01460008	A – Back with central lug
01460009	B – Back with offset lug

A Dull chrome-plated except for model numbers 01460016, 01460017.

Backs for dial gauges TESA YR – YE / MERCER / COMPAC / DIGICO 200-700 – Ø 58 and 82mm dial models

No	A
01460014	C – Back with central lug
01460015	D – Back with offset lug

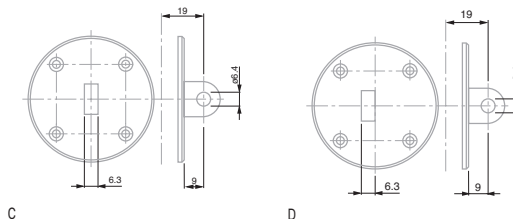



Lever-type Dial Test Indicators



TESA IP65 Electronic Dial Test Indicators

Provides the advantages of a mechanical test indicator with a digital reading.



- Inductive patented measuring system.
- Analogue and digital indication.
- Digital step of 0,01/0,001 mm.
- Selectable scale division: 10, 20, 50 μm /1, 2, 5 μm .
- Cutting oils and liquid coolant resistant (IP65).
- Metric/inch conversion.
- RS232 data output combined with external power supply.
- Displayed measuring modes (NOR/MIN/MAX/MAX-MIN).
- Automatic shut-down.
- Compatible with all TESAST accessories.

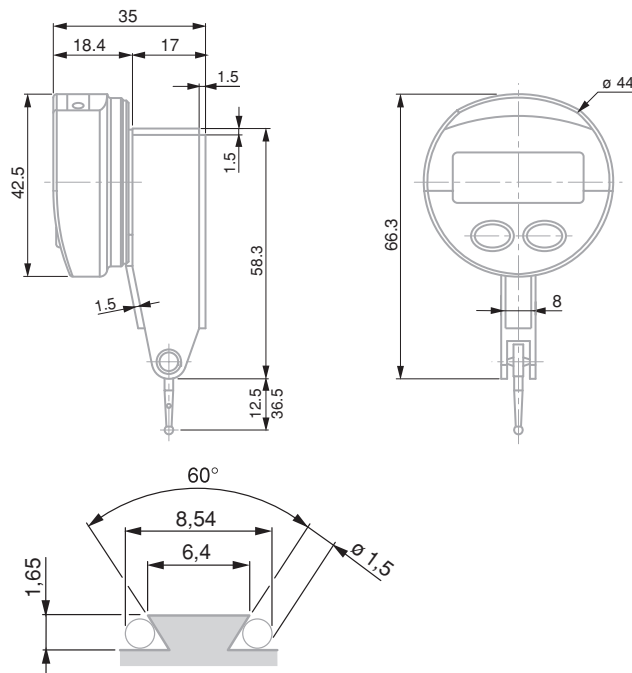

- LCD, 5 digits + unit
- Display digit height 6 mm
- Max. perm. errors:
 $f_e = 10 \mu\text{m}$
 $f_{\text{res}} = 13 \mu\text{m}$
Pre-span = 0,05 mm
- Repeatability:
 $f_w = 1 \mu\text{m}$
- Hysteresis:
 $f_h = 3 \mu\text{m}$
- L = 12,5 mm;
max. 0,05 m/s
L = 36,5 mm;
max. 0,15 m/s
- Number of measurements per second: 9
- Zero-setting
- RS232
- 3 V lithium battery, type CR2032
- Battery life > 4000 hours
- Operating temperature range: +5°C to +40°C
- Degree of protection: IP65 (IEC 529)
- EN 61326-1
- 73 g (L = 12,5 mm)
75 g (L = 36,5 mm)
- Supplied in a plastic case with:
1 Insert with a 2 mm dia. (No. 01860202)
1 Wrench (No. 01860307)
1 Mounting rod 8 mm dia. (No. 01840105)

	mm	mm	in	N ($\pm 15\%$)	Stem length, mm	
01830001	0,8	0,01/0,001	0.0005/0.00005	0,13	12,5	
01830002	0,5	0,01/0,001	0.0005/0.00005	0,07	36,5	

OPTIONAL ACCESSORIES:

- 01961000 Lithium battery, 3V, CR2032
 - 04761060 RS 232 cable with external power supply
- Compatible with all TESAST measuring inserts and accessories

TESATAST DIAL TEST INDICATORS

These lever-type dial test indicators are especially intended for use on the shop floor or in the inspection room – Ideally suited for comparative measurements on a surface plate, for instance – Determine form, shape and position deviations as well as axial and runout errors.

- Bidirectional measuring with automatic reversal inside the movement.
- Continuous clockwise pointer rotation providing error-free reading.
- Insensitive to magnetic fields.
- Jewelled movement with 7 rubies.
- Ball-bearing lever system. Measuring insert swivelling through to 240°.
- Very low measuring force.
- Exceptionally robust with full-metal construction.

Standard model

Well proven over thousands of times. The dial face is parallel to the axis of the measuring insert.

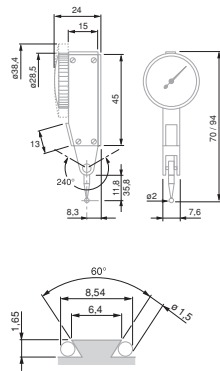

Perpendicular model

Lever test indicator with dial face mounted at right angle to the axis of the measuring insert.

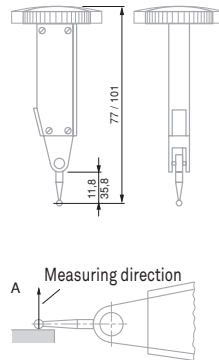

Lateral Model

Dial test indicator with dial face mounted parallel to the axis of the measuring insert but on the flat side of the dial housing.

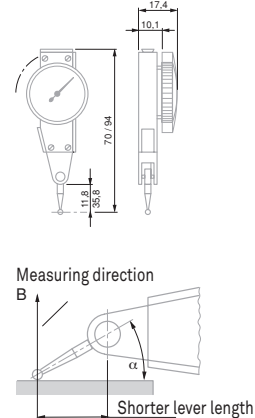

Note on the use of TESATAST dial test indicators

With the measuring insert lying parallel to the workpiece surface (Fig. A), these indicators give true reading due to the amplification factor to 1:1.

In another measuring position (angle α in Fig. B), the effective lever length changes so that the read value needs to be corrected. With respect to this, also refer to the instruction manual.

Permissible limits of a metrological characteristic (MPE/MPL)

		0,02 mm	0,01 mm	0,001 mm / 0,002 mm
Deviation span, f_e		27 μm	10 μm	2 μm
Deviation span within the local measuring span, f_t	0,20 mm	12 μm		
	0,10 mm		5 μm	
	0,02 mm			1 μm
Total deviation span, f_{ges}		31 μm	13 μm	3,5 μm
Repeatability limit, f_w		4 μm	3 μm	1 μm
Max. hysteresis, f_u		4 μm	3 μm	1,5 μm
Measuring force with insert:	Length	12,53 mm	0,15 N	0,15 N
		36,53 mm	0,06 N	0,06 N





TESATAST Standard Models

No					
	mm	mm	Ø, mm		Insert, mm
01810005	0,8	0,01	28	0 ÷ 0,4 ÷ 0	12,53
01810006	0,8	0,01	38	0 ÷ 0,4 ÷ 0	12,53
01810007	0,5	0,01	28	0 ÷ 0,25 ÷ 0	36,53
01810008	0,5	0,01	38	0 ÷ 0,25 ÷ 0	36,53
01810009	0,2	0,002	28	0 ÷ 100 ÷ 0	12,53
01810010	0,2	0,002	38	0 ÷ 100 ÷ 0	12,53
S18001695	0,2	0,001	38	0 ÷ 100 ÷ 0	12,53



SWISSTAST Standard Models

No					
	mm	mm	Ø, mm		Insert, mm
01811000	0,8	0,01	28	0 ÷ 0,4 ÷ 0	12,53
01811001	0,2	0,002	38	0 ÷ 100 ÷ 0	12,53

Same technical data as standard models, but equipped with a 2 mm dia. ruby ball tip No. 01860302.



TESATAST Perpendicular Models

No					
	mm	mm	Ø, mm		Insert, mm
01810204	0,8	0,01	28	0 ÷ 0,4 ÷ 0	12,53
01810205	0,5	0,01	28	0 ÷ 0,25 ÷ 0	36,53
01810304	0,2	0,01	38	0 ÷ 100 ÷ 0	12,53

- DIN 2270
NFE 11-053
- Rotating dial
- Very low measuring force, see table.
- Movement with patented shock proof system
- Lever system with friction drive to prevent overload
- Accuracy: see table.
- Supplied in a plastic case together with:
1 Insert with a 2 mm dia.
1 Wrench (No. 01860307)
1 Mounting rod 8 mm dia.
(No. 01840105)

TESATAST Lateral Models



No					
	mm	mm	∅, mm		Insert, mm
01810011	0,8	0,01	28	0 ÷ 0.4 ÷ 0	12,53
01810012	2	0,02	38	0 ÷ 1.0 ÷ 0	36,53
01810013	0,2	0,002	28	0 ÷ 100 ÷ 0	12,53



TESATAST Measuring Inserts

No			
	Ball tip, mm	Ball tip material	mm
01860201	1	Carbide	12,53
01860202	2	Carbide	12,53
01860203	3	Carbide	12,53
01860211	1	Carbide	36,53
01860212	2	Carbide	36,53
01860213	3	Carbide	36,53
01860301	1	Ruby	12,53
01860302	2	Ruby	12,53
01860303	3	Ruby	12,53
01860304	1	Ruby	36,53
01860305	2	Ruby	36,53
01860307	Wrench for inserts		

Note:

The original measuring insert mounted on every TESATAST as well as any other insert of the same nominal length but with a different ball tip diameter are fully interchangeable.

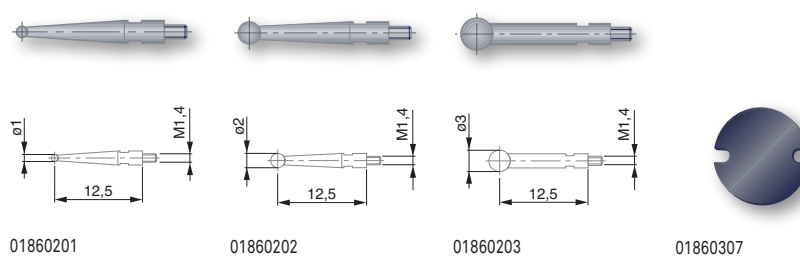

Indicator Sets with Small Support

No	
01630003	Indicator set with small support
COMPOSITION OF THE SETS:	
01810005	TESATAST standard model
01810010	TESATAST standard model
01860203	Carbide measuring insert
01840104	Mounting rod
01840105	Mounting rod
01860307	Wrench for inserts
01639007	Magnetic support INTERAPID UJ15, dovetail clamp and ∅ 8 mm cylindrical clamping



Accessories for TESATAST

Clamp

No	=		mm
01860401	Dovetail clamp with tightening screw	$\emptyset 5,6 / \emptyset 9,5$	



01860401

Mounting Rods

No	=		mm
01840404	Short swivel holder	$\emptyset 8 \times 25$	
01840405	Long swivel holder	$\emptyset 8 \times 90$	
01840406	Angular swivel holder	$\emptyset 8 \times 25$ ($\emptyset 8$ for clamping bore)	
01840501	Centering holder	$\emptyset 8 \times 25$ ($\emptyset 4$ for clamping point)	
01840407	Long sw. holder, fine adjust	$\emptyset 8 \times 125$	



01840501



01840404



01840405



01840406



01840407

Fixing Shank

No	=		mm
01840104	Mounting rod	$\emptyset 4$	
01840105	Mounting rod	$\emptyset 8$	
01840202	Cylindrical fixing shank	$\emptyset 8 \times 80$ ($\emptyset 5,6$ for the tenon)	
01860008	Mounting rod	$\emptyset 6$	

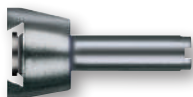

01840104

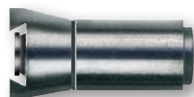

01840105



01840202

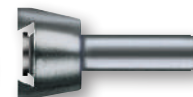

01860008

INTERAPID 312 LEVER DIAL TEST INDICATORS

INTERAPID 312 Dial Test Indicators very large measuring span – Ideal for inspecting all significant size variations, e.g. on the surface plate – Measures position, form and shape errors.



- Safe reading thanks to secondary pointer totalling the number of revolutions made by the main pointer.
- Bidirectional measuring with automatic reversal within the movement.
- Pointer rotation direction is always constant due to automatic reversal effect.
- Jewelled movement with rubies.
- Ball-bearing lever system. Measuring insert swivelling through 210°.
- Particularly robust due to full-metal construction.
- Monobloc housing with mounting through dovetail clamping and a Ø 4 mm swivelling shank.

Stylus insert with angular position of 12°

All models INTERAPID 312 are designed to give a true reading when the angle between the stylus and the workpiece surface is 12° (Fig. A). In any other measuring position, including parallel position of the stylus against the workpiece surface, measured readings have to be corrected accordingly (Fig. B). Please consult the instruction manual on this subject.

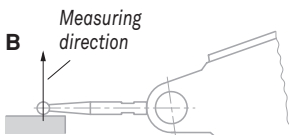
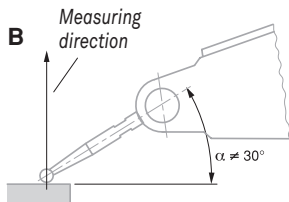
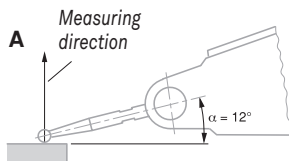

Standard Model

Time-tested dial test indicator. The dial face is mounted parallel to the axis of the insert.

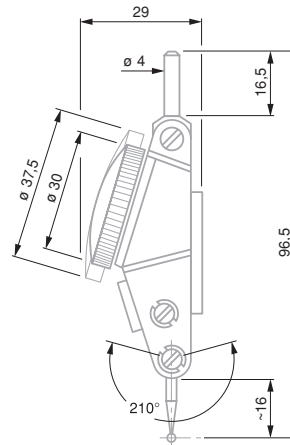

Perpendicular model

Dial test indicator with dial face mounted at right angle to the axis of the insert.

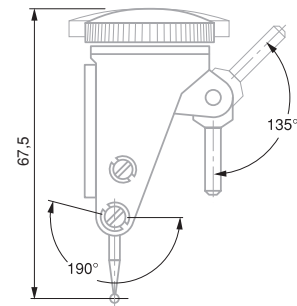

Permissible limits of a metrological characteristic (MPE/MPL)

	0,01 mm		0,002 mm	
	Pointer revolution		Pointer revolution	
	1	2	1	2
Deviation range over partial measuring range, f_e	10 μm	20 μm	4 μm	8 μm
Total deviation range, f_{ges}	13 μm	23 μm	6 μm	10 μm
Repeatability limit, f_w	3 μm		1 μm	
Max. hysteresis, f_u	3 μm		2 μm	
Measuring force	0,12 N		0,25 N	





INTERAPID 312 Standard Models

No	mm	mm	∅, mm		Insert, mm
074111366	1,6	0,01	37,5	0 ÷ 40 ÷ 0	16,5
074111367	1,6	0,01	30	0 ÷ 40 ÷ 0	16,5
074111368	0,4	0,002	37,5	0 ÷ 10 ÷ 0	15,2
074111369	0,4	0,002	30	0 ÷ 10 ÷ 0	15,2

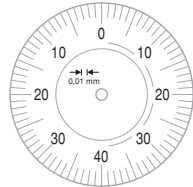

074111366

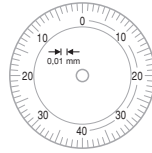

074111367

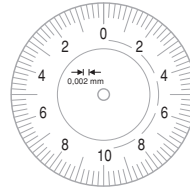

074111368

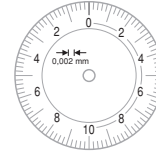

074111369



INTERAPID 312 Perpendicular Models

No	mm	mm	∅, mm		Insert, mm
074111375	1,6	0,01	37,5	0 ÷ 40 ÷ 0	16,5
074111376	1,6	0,01	30	0 ÷ 40 ÷ 0	16,5

Dial Test Indicator Sets, Complete with Accessories – INTERAPID 312 Standard Models

Each full set consists of:



No	=
	INTERAPID 312 lever test indicators as listed in the table below:
074106331	Rectangular mounting attachment
074108942	Reducing sleeve, metric
074106026	Swivel holder, metric
074111474	Case for measuring inserts
01860307	Wrench for measuring inserts

No	074111366	074111367	074111368	074111369	074106331	074108942	074106026	074111474	01860307
074111502	•			•	•	•	•	•	•
074111503		•			•	•	•	•	•
074111504			•		•	•	•	•	•
074111505				•	•	•	•	•	•

- Rotating dial
- Very low measuring force: (see table for tolerance limits)
- Lever system with friction drive to prevent overload
- Accuracy: see table for tolerance limits
- Supplied in a plastic case with:
1 with a ∅ 2 mm insert in hardened steel,
1 stylus key
No. 01860307

Technical data: see description for each product

M1,7 coupling thread

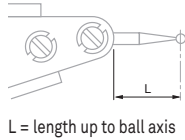

Measuring Inserts

No	mm	Ball tip, mm	Ball tip material	L mm
074107893	0,01	2	Steel	16,5
074107895	0,01	1,5	Steel	16,5
074107897	0,01	0,8	Steel	16,5
074110481	0,002	2	Steel	15,2
074110492	0,002	1,5	Steel	15,2
074110493	0,002	0,8	Steel	15,2
074105993	0,01	2	Carbide	16,5
074105994	0,01	1,5	Carbide	16,5
074105995	0,01	0,8	Carbide	16,5
074106358	*	2	Carbide	36,6
074106360	*	0,8	Carbide	36,6
074110482	0,002	2	Carbide	15,2
074110491	0,002	1,5	Carbide	15,2
074110507	0,002	0,8	Carbide	15,2

* The length of the insert used changes the amplification factor of the lever system. The values read off must therefore be doubled.

Note:

The original measuring insert mounted on every INTERAPID 312 as well as any other insert of the same nominal length but with a different ball tip diameter are fully interchangeable.

Accessories for INTERAPID 312

Clamping Attachment

No	=	mm
074108603	Double attachment with clamping point and dovetail	∅ 4

HOLDERS

No	=	mm
074106026	Swivel holder with clamping points and dovetail	∅ 8 x 133 (∅ 4 for clamping point)

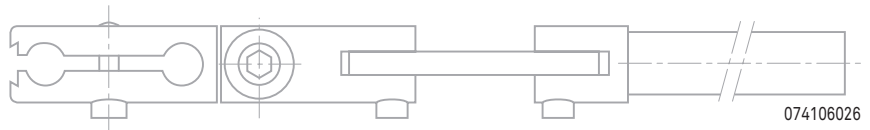

Clamping Attachment

No	=	
074106331	Rectangular clamping attachment complete	

074106331

Reducing Sleeve

No	=	mm
074108942	Reducing sleeve	∅ 8 / ∅ 4

074108942



COMPAC DIAL TEST INDICATORS

Essential for the workshop, but also in the inspection room or measuring laboratory – Ideal for comparative measurement on a surface plate – Detect form and position errors – Measure axial and radial runouts, especially.

Technical Features

- Long measuring travel, up to 3 mm.
- Bidirectional measuring, without reversing lever.
- Same rotation direction of pointers in the two measuring directions (clockwise pointer direction).
- Swivelling probe through 180°.
- Main pivot on self-aligning angular bearings, dimensioned oversize.
- Dovetail mounting machined in the indicator housing.
- Dull chrome-plated bezel and housing.
- Rotating dial.
- Insensitive to magnetic fields generated in mechanical workshops.

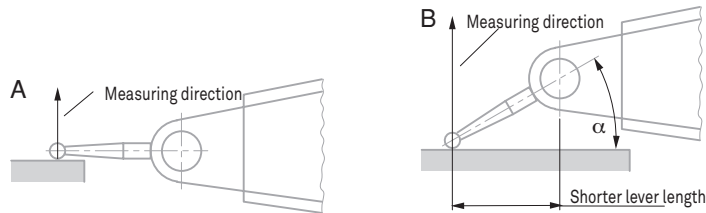

Note for use of COMPAC dial test indicators

With the measuring insert lying parallel to the workpiece surface (Fig. A), these dial test indicators give true reading due to the amplification factor of 1:1. In any other measuring position (angle α in Fig. B), the effective lever length changes. The values indicated need be corrected. In this connection, please consult the instruction manual.



N DIN 2270 and factory standard

Rotating dial

Contact points with tungsten carbide ball tips

Friction lever system to prevent overload

Supplied in a plastic case, including:
 1 contact point, 2 mm dia.
 1 rigid stem 8 mm dia., L = 15 mm, No. 01840107
 1 rigid stem 4 mm dia., L = 15 mm, No. 01840109 (except for series 220).

Inspection report with a declaration of conformity

COMPAC Series 210 – Standard Models, Metric

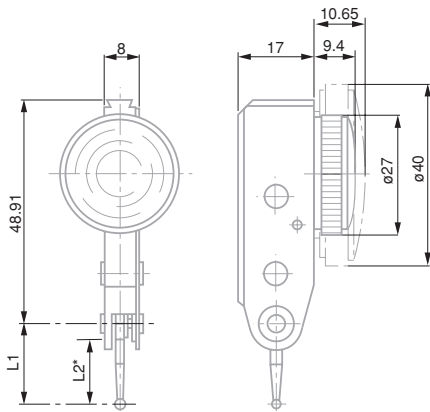

L2; see table of inserts for COMPAC lever-type test indicators

No	Total travel, mm	μm	μm	μm	μm	Travel/revolution, mm	\varnothing , mm	N	Insert L1, mm	
213	1,5	0,01	13	3	3	0,5	27	0 ÷ 25 ÷ 50	≤ 0,35	18
213G	1,5	0,01	13	3	3	0,5	40	0 ÷ 25 ÷ 50	≤ 0,35	18
212L	3	0,01	26	3	6	1	27	0 ÷ 50 ÷ 100	≤ 0,20	36
212GL	3	0,01	26	3	6	1	40	0 ÷ 50 ÷ 100	≤ 0,20	36
215	0,6	0,002	13	1,5	2,5	0,1	27	0 ÷ 5 ÷ 10	≤ 0,30	18
215G	0,6	0,002	13	1,5	2,5	0,1	40	0 ÷ 5 ÷ 10	≤ 0,30	18
215GL	1,2	0,002	26	1,5	5	0,2	40	0 ÷ 10 ÷ 20	≤ 0,20	36
216G	0,6	0,001	13	1,5	2,5	0,1	40	0 ÷ 5 ÷ 10	≤ 0,30	18

COMPAC Series 220 – Perpendicular Models, Metric

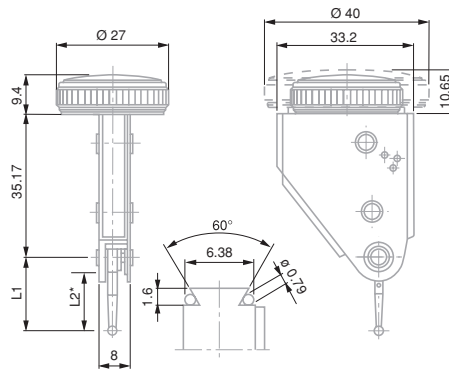

*L2 see table of inserts for COMPAC lever-type test indicators

No	Total travel, mm	μm	μm	μm	μm	Travel/revolution, mm	\varnothing , mm	N	Insert L1, mm	
223	1,5	0,01	13	3	3	0,5	27	0 ÷ 25 ÷ 50	≤ 0,35	18
223G	1,5	0,01	13	3	3	0,5	40	0 ÷ 25 ÷ 50	≤ 0,35	18
222L	3	0,01	26	3	6	1	27	0 ÷ 50 ÷ 100	≤ 0,20	36
222GL	3	0,01	26	3	6	1	40	0 ÷ 50 ÷ 100	≤ 0,20	36
225	0,6	0,002	13	1,5	2,5	0,1	27	0 ÷ 5 ÷ 10	≤ 0,30	18
225G	0,6	0,002	13	1,5	2,5	0,1	40	0 ÷ 5 ÷ 10	≤ 0,30	18



COMPAC 230 Parallel Models

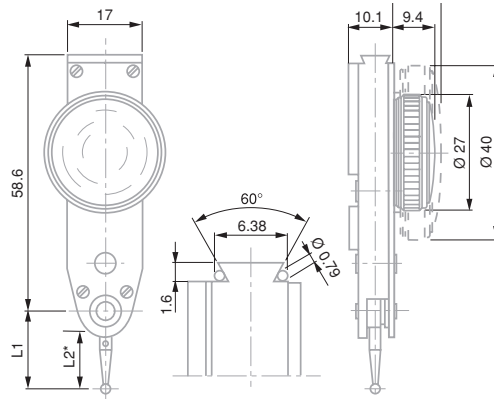

* L1 see table of inserts for COMPAC lever-type indicators

No	Total travel, mm	mm	µm	µm	µm	Travel/revolution, mm	Ø, mm		N	Insert L1, mm
233	1,5	0,01	13	3	3	0,5	27	0 ÷ 25 ÷ 50	≤ 0,35	18
233G	1,5	0,01	13	3	3	0,5	40	0 ÷ 25 ÷ 50	≤ 0,35	18
232L	3	0,01	26	3	6	1	27	0 ÷ 50 ÷ 100	≤ 0,20	36
232GL	3	0,01	26	3	6	1	40	0 ÷ 50 ÷ 100	≤ 0,20	36
235G	0,6	0,002	13	1,5	2,5	0,1	40	0 ÷ 5 ÷ 10	≤ 0,30	18

- DIN 2270 and factory standard
- Rotating dial
- Contact points with tungsten carbide ball tips
- Friction lever system to prevent overload
- Supplied in a plastic storage case, including:
1 contact point, 2 mm dia.
1 rigid stem 8 mm dia., L = 15 mm, No. 01840107,
1 rigid stem 4 mm dia., L = 15 mm, No. 01840109
- Inspection report with a declaration of conformity

COMPAC 240 Reduced Range Models

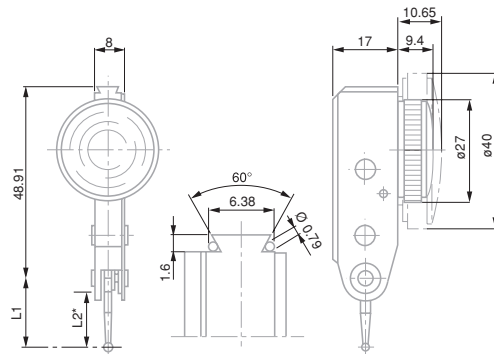

* L2 see table of inserts for COMPAC lever-type indicators

No	Total travel mm	mm	µm	µm	µm	Ø, mm	N	Insert L1, mm	
242	0,8	0,01	13	3	3	27	0 ÷ 40 ÷ 0	≤ 0,25	18
242G	0,8	0,01	13	3	3	40	0 ÷ 40 ÷ 0	≤ 0,25	18
243L	0,5	0,01	13	3	3,5	27	0 ÷ 25 ÷ 0	≤ 0,10	45
243GL	0,5	0,01	13	3	3,5	40	0 ÷ 25 ÷ 0	≤ 0,10	45
245	0,2	0,002	4	1,5	2	27	0 ÷ 10 ÷ 0	≤ 0,25	18
245G	0,2	0,002	4	1,5	2	40	0 ÷ 10 ÷ 0	≤ 0,25	18

M1,6 coupling thread

The original inserts mounted on all indicators are fully interchangeable with inserts with different diameter tips as long as the insert has the same nominal length.

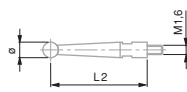

L1 = Axial length from ball to pivot



01866014

Measuring Inserts for COMPAC Models

No	Ball tip, mm	Ball tip material	L1, mm	L2, mm
01866014	0,8	Carbide	18	14,26
01866003	2	Carbide	18	14,26
01866021	3	Carbide	18	14,26
01866016	0,8	Carbide	36	32,26
01866004	2	Carbide	36	32,26
01866023	3	Carbide	36	32,26
01866015	0,8	Carbide	45	41,26
01866006	2	Carbide	45	41,26
01866022	3	Carbide	45	41,26
01866026	2	Ruby	18	14,26
01866027	2	Ruby	36	32,26

Accessories for COMPAC

Swivel Clamps



SPT

No	Stem	Clamping length
SPT	8 mm	25 mm
SPTA	1/4 in	1 in

Mounting Rods with Dovetail Grip

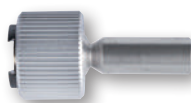

01850106

No		
01850106	Fixing shank swivelling through +/-30°	1/4 in
01850107	Rigid fixing shank	1/4 in
01840106	Fixing shank swivelling through +/-30°	8 mm
01840107	Rigid fixing shank Ø8mm	8 mm
01840108	Fixing shank swivelling through +/-30°	4 mm
01840109	Rigid fixing shank Ø4mm	4 mm



Clamp

No	=	
01860401	Dovetail clamp with tightening screw	mm Ø 5,6 / Ø 9,5



01860401

Mounting Rods

No	=	
01840404	Short swivel holder	mm Ø 8 x 25
01840405	Long swivel holder	Ø 8 x 90
01840406	Angular swivel holder	Ø 8 x 25 (Ø 8 for clamping bore)
01840501	Centering holder	Ø 8 x 25 (Ø 4 for clamping point)
01840407	Long sw. holder, fine adjust	Ø 8 x 125



01840501



01840404



01840405



01840406



01840407

Fixing Shank

No	=	
01840104	Mounting rod	mm Ø 4
01840105	Mounting rod with dovetail clamp	Ø 8
01840202	Cylindrical fixing shank	Ø 8 x 80 (Ø 5,6 for the tenon)
01860008	Mounting rod	Ø 6

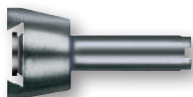

01840104

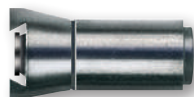

01840105



01840202

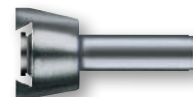

01860008

Comparative Measurement



TESA TPS - Motorised setting benches

The TPS are designed for setting hand-held measuring instruments and replace a complete set of ring gauges.







The setting bench is typically used with comparative measuring instruments such as dial gauges, lever-type dial test indicators or 2-point bore gauges.

TPS is very simple to use: enter the value and the mobile slide will automatically position itself at this value.

It can be used for checking internal as well as external dimensions of up to 1000 mm, according to the model.





Special adapters help to position the instrument, so that is very easy and quick to use and human errors can be avoided.

For versions with dimensions over 1000 mm, please contact TESA.

-  0,001 mm
-  Linear 1,5 + L (mm) / 300 µm
-  1 µm
-  100/240 AC – 1,5 A 50/60 Hz
-  Inspection report
-  RS232
-  Holding force 240 N



TESA TPS 500 + 02160027 + 02160024 (+ DIGICO 705)

No	=				
		Internal, mm	External, mm	mm	Kg
02130001	TESA TPS 300	0,1 ÷ 300	40 ÷ 340	610 x 300 x 270	75
02130002	TESA TPS 500	0,1 ÷ 500	40 ÷ 540	820 x 300 x 300	90
02130003	TESA TPS 1000	0,1 ÷ 1000	40 ÷ 1040	1330 x 340 x 340	240

CONSISTING OF:

02160038	Power supply 80 ÷ 240 V, 50 ÷ 60 Hz
02160027	Mobile stop adapter

The maximum permissible errors indicated for a metrological characteristic (MPE) have been obtained at a temperature of 20° ± 0,5°C and relative humidity of 50 ± 5 %.

Accessories for Bore Gauges

Accessories for TESA VERIBOR bore gauges with round foot are available for different application ranges of up to 50 mm.

They offer a perfect setting by blocking the X and Z axis' rotating movements to let only the Y axis moving to find the min. point.

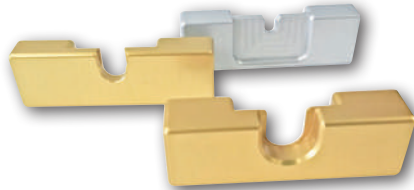
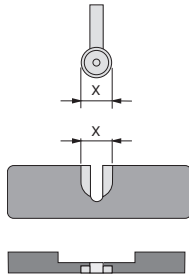

02160021 + TESA VERIBOR

No	mm	X, mm
02160020	4,5 ÷ 6	Ø 4,5
02160021	6 ÷ 12,5	Ø 5,8
S21050003	12 ÷ 25	Ø 9,5
02160023	25 ÷ 50	Ø 17,5

Accessories for Bore Gauge

Accessories for TESA VERIBOR bore gauges with rectangular foot are available for different application ranges from 50 mm up to 550 mm.

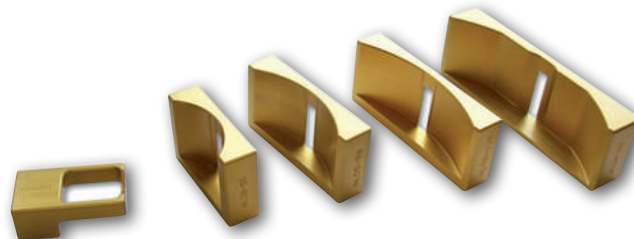
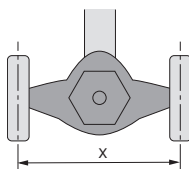

02160027

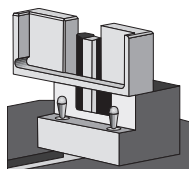

02160024

No	mm	X, mm
02160024	50 ÷ 150	30 ÷ 55
02160025	150 ÷ 300	55 ÷ 90
02160026	240 ÷ 550	90 ÷ 125
02160043		120 ÷ 170
02160044		170 ÷ 220

Each TESA TPS bench is delivered with an adapter No. 02160027



02160027 + 02160024 + TESA VERIBOR



Accessory for External Micrometers

Set of accessories that allow horizontal alignment of the 2 measuring faces of the external micrometer.

Application range up to 150 mm = 1 piece required

Application range from 150 mm = 2 pieces required

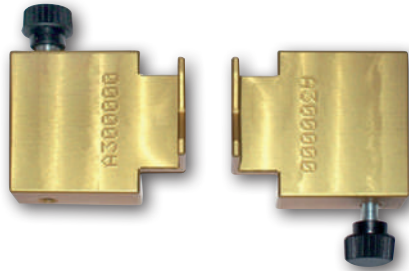

02160029

	
	mm
02160029	40 ÷ 300 / 500 / 1000

Delivered individually



02160029 + TESA MICROMASTER

Accessory for TESA YA Bore Gauges

TESA YA bore gauges accessory is an assembly of few parts that accept all measuring ranges and make the min. point much easier to find.

	
	mm
02160028	6 ÷ 12,5

Delivered with 3 adapter rings for Ø 8, 10 et 14 mm

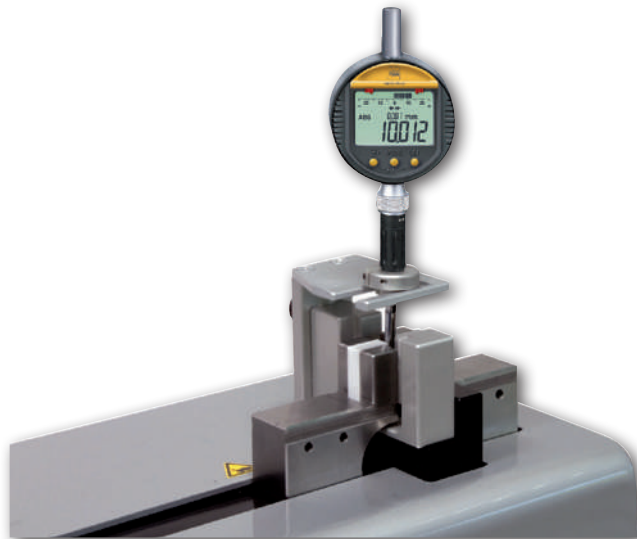

02160028 + TESA DIGICO

Accessories for Dial Gauges

A composition of 2 parts for fixing dial gauges on the fixed part of the bench.

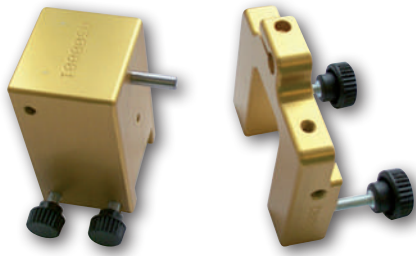

02160035

	
	mm
02160035	10 ÷ 150

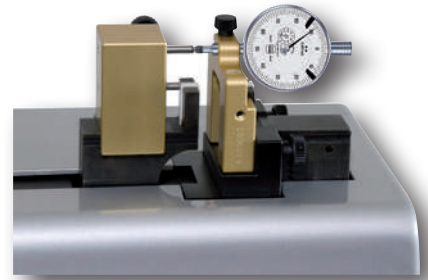

Accessory for Internal Arm Comparator

Set of accessories for horizontal alignment of the 2 measuring points, 2 items required.



02160030

	
	mm
02160030	10 ÷ 150

Delivered individually

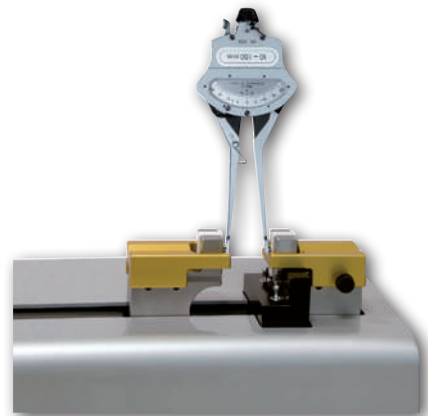

02160030 + TESA IRA 2



TESA YA COMPLETE INSTRUMENT SETS

Specially designed for small bores from 0,47 up to 12,20 mm - Checking of dimension and bore form errors through 2-point measuring - Offers an excellent repeatability. The YA bore gauges consist of an interchangeable measuring head with a built-in needle and handle with a 8 mm diameter fixing bore for a dial gauge or any other type of sensor

- Measuring heads with spherical faces for through bores.
- Measuring heads for particularly deep bores.

Can be supplied on request:

- Measuring heads with carbide measuring faces.
- Measuring heads for special applications.
- Measuring heads for blind bores and particularly deep bores with other application ranges.
- Carbide measuring needles.
- Depth extensions 125, 250, 500, 750 and 1000 mm.

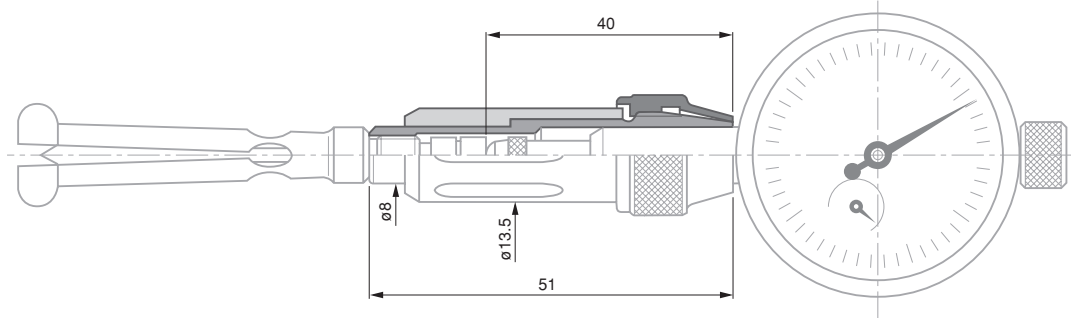
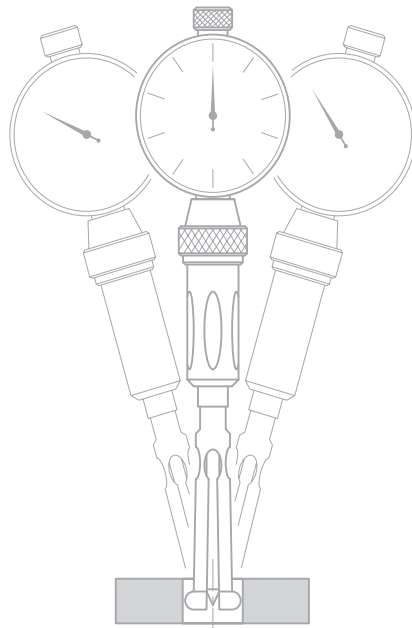



1 µm

Reliability of engraved dimension:
± 2s = 1 µm

Measuring head in hardened steel and carbide, ≈ 1000 HV 25
Measuring needles in hardened steel, ≈ 800 HV 25
Setting rings: with synthetic sapphire for nominal Ø ≤ 1,5 mm and hardened steel for > 1,5 mm, ≈ 780 HV 25

Holder: Mounting of instruments with stem Ø 8h6 mm

Complete set includes:
1 handle No. 01540201.
Measuring heads, needles and setting rings as shown in the table below.
1 TESA YR 01410212 dial gauge (reading to 0,01 mm, Ø 40 mm dial)
1 Extension for for inserts, 10 mm No. 03540501.

COMPLETE INSTRUMENT SETS FOR MEASURING THROUGH BORES



mm

01510000	0,47 ÷ 0,97
01510100	0,95 ÷ 2,45
01510200	2,30 ÷ 6,20
01510300	6,00 ÷ 12,20

	Measuring heads	mm	Measuring depth max. mm	Measuring depth min. mm	Needles	Setting rings mm		
COMPOSITION OF THE SETS:								
01510000	01540401	0,47 ÷ 0,53	1,5	0,25	01540001	01540601	0,50	
	01540402	0,52 ÷ 0,58	1,8	0,27	01540001	01540602	0,55	
	01540403	0,57 ÷ 0,67	2,0	0,29	01540002	01540603	0,60	
	01540404	0,65 ÷ 0,77	2,5	0,31	01540002	01540604	0,70	
	01540405	0,75 ÷ 0,87	2,8	0,33	01540002	01540605	0,80	
	01540406	0,85 ÷ 0,97	3,0	0,35	01540002	01540606	0,90	
	01510100	01540407	0,95 ÷ 1,15	11	0,6	01540003	01540607	1,00
		01540408	1,07 ÷ 1,25	11	0,6	01540003	01540608	1,10
		01540409	1,17 ÷ 1,35	11	0,6	01540003	01540609	1,20
		01540410	1,27 ÷ 1,45	11	0,6	01540003	01540610	1,30
		01540411	1,37 ÷ 1,55	11	0,6	01540003	01540611	1,40
		01540412	1,50 ÷ 1,90	17	0,9	01540004	01540612	1,50
		01540413	1,70 ÷ 2,15	17	0,9	01540004	01540613	1,75
		01540414	2,05 ÷ 2,45	17	0,9	01540004	01540614	2,00
					01540615	2,25		
01510200	01540415	2,30 ÷ 2,75	22	1,2	01540005	01540616	2,50	
	01540416	2,65 ÷ 3,20	22	1,2	01540005	01540617	3,00	
	01540417	3,05 ÷ 3,50	22	1,2	01540005	01540618	3,25	
	01540418	3,35 ÷ 3,85	22	1,2	01540005	01540619	3,50	
	01540419	3,80 ÷ 4,30	22	1,2	01540005	01540620	4,00	
	01540420	4,20 ÷ 5,00	40	2,0	01540006	01540621	4,50	
	01540421	4,70 ÷ 5,50	40	2,0	01540006	01540622	5,00	
	01540422	5,30 ÷ 6,20	40	2,0	01540006	01540623	5,75	
	01510300	01540423	6,00 ÷ 6,80	40	2,0	01540006	01540624	6,50
		01540424	6,60 ÷ 7,50	40	2,0	01540006	01540625	7,00
01540425		7,30 ÷ 8,15	40	2,0	01540006	01540626	7,75	
01540426		8,00 ÷ 8,80	40	2,0	01540006	01540627	8,50	
01540427		8,50 ÷ 9,40	50	2,0	01540006	01540628	9,00	
01540428		9,15 ÷ 10,00	50	2,0	01540006	01540629	9,50	
01540429		9,60 ÷ 10,80	50	3,3	01540007	01540630	10,00	
01540430		10,65 ÷ 12,20	50	3,3	01540007	01540631	11,50	



Special Executions

Available upon request :

- Full instrument sets for measuring blind bores and short centering shoulders.
- Measuring heads with tungsten carbide tipped measuring faces.
- Measuring heads for special applications.
- Measuring heads for through bores, particularly deeper ones covering other application ranges.
- Tungsten carbide measuring needles.
- 125, 250, 500, 750 and 1000 mm depth extensions.

Optional Accessories for TESA YA Bore Gauges

Measuring stand for stationary use.



01639009 INTERAPID UA 30 Support

MUST BE EQUIPPED WITH:

01610201 UK 25 sliding arm.
Used with TESA YA for stationary bore measurement on UA30 support.

01640000 UAZ 10 depth stop plate for UA 30

TESA VERIBOR

Proven design and reliability never questioned over decades – Instruments for 2-point measurements for bores from 4,5 up to 550 mm – Detects form errors – Gauge body with a 8 mm diameter clamping bore for a dial gauge, precision indicator or any other sensor.

- Excellent repeatability due to the circular element fixed on the instrument ensuring practically no play.
- Gauge body made of invar steel to neutralise the influence of the operator's hand warmth on the measuring result.
- Centring shoe for correct alignment of the instrument in the bore.
- Tungsten carbide ball tips for high resistance to wear.

TESA VERIBOR Light

Instrument with 2 contact points for comparative measurement of bores and detection of form errors – Automatic self-centering in the bore – Can be used with a dial gauge, a precision indicator or a probe with \varnothing 8h6 clamping stem.



4 µm



2 µm

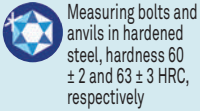

Measuring bolts and anvils in hardened steel, hardness 60 \pm 2 and 63 \pm 3 HRC, respectively

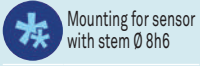

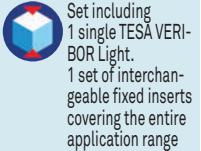

Mounting for sensor with stem \varnothing 8h6



Set including 1 single TESA VERIBOR Light. 1 set of interchangeable fixed inserts covering the entire application range







No	=			
		Measuring bolt travel, mm	mm	Measuring depth, mm
05710090	TESA VERIBOR light	1,30	18 ÷ 35	176
05710091	TESA VERIBOR light	1,40	35 ÷ 60	178
05710092	TESA VERIBOR light	1,40	50 ÷ 150	178
05710093	TESA VERIBOR light	1,30 / 1,40	18 ÷ 150	176 / 178

Sets delivered without dial gauge



TESA VERIBOR



-  Only VERIBOR without dial gauge: 2 μm
-  Only VERIBOR without dial gauge: ± 2s = 0,5 μm
-  Measuring bolts and anvils fitted with carbide ball tips
-  Mounting for sensor with stem Ø 8 h6 mm
-  Set including 1 single TESA VERIBOR.
1 set of interchangeable fixed inserts covering the whole application range.

No	mm
05710012	4,5 ÷ 6
05710013	6 ÷ 12,5
05710014	12 ÷ 25
05710015	25 ÷ 50
05710016	50 ÷ 150
05710018	50 ÷ 300
05710017	240 ÷ 550

Sets supplied without dial gauges, electronic probes or indicators

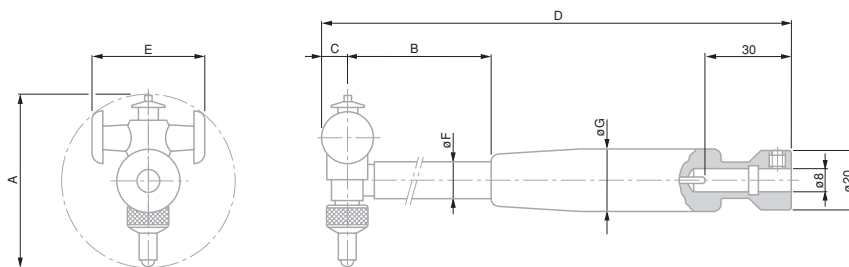

A mm	mm	B mm	C mm	D mm	E mm	F mm	G mm
4,5 ÷ 6	0,35	74	2	138	3,3	3,8	16
6 ÷ 12,5	0,5	93	2,6	156	4,3	4,9	16
12 ÷ 25	0,9	106	4,5	194	7,8	7,9	19
25 ÷ 50	1,3	140	6	228	16	8	19
50 ÷ 150	1,4	173	10	279	36	12	23
50 ÷ 300	1,4	173	10	279	36 / 66	12	23
240 ÷ 550	1,6	227	14	347	112	18	28

Special Versions

Available on request :

- TESA VERIBOR for blind bores and centring shoulders.
- TESA VERIBOR elbow-shaped for hard-to-reach bores.
- Handtools for measuring the distance between two plan-parallel surfaces.
- Handtools for inspecting gear pitch diameters.

ACCESSORIES FOR TESA VERIBOR

Set of Extensions

For extending the application range to \varnothing 300 mm for VERIBOR No. 05710016.

No	=	Consisting of
05740001	Set of extensions	- 1 Centring shoe - 3 Extensions 50 mm



Depth Extensions

To be mounted on the body of VERIBOR $\varnothing \geq 25 \leq 550$ mm for large measuring depths (dimension B in the technical drawing of the VERIBOR).

No	=	mm
05760029	Extension	1000
05760027	Extension	500



Dial Gauge Protection Guard

Protects the dial gauge against direct shocks and prevents the dial from being inadvertently rotated.

No	=	mm
05760013	Protection guard	\varnothing 58



ARM GAUGES

Very practical comparative measuring instrument – Measures at 2 or 3 points depending on the accessory used – Ideal for blind or through bores – also suited for measuring grooves, flutes as well as the internal measurement of parts with parallel faces.

IRA 2 Comparative Gauge

- Large application range from 10 to 150 mm
- Easy to handle thanks to its light weight and ergonomic design
- Built-in indicator with 0,01 mm reading and fine setting
- Centering device for 2-point measurement

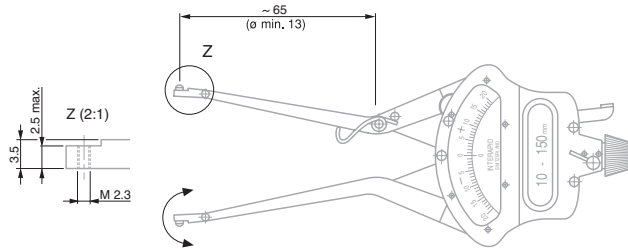
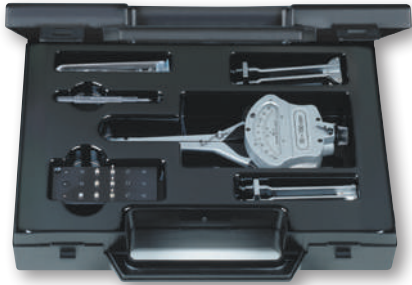

No	=	A
079105704	INTERAPID IRA 2	mm
079111401	INTERAPID IRA 2, carbide	mm
DELIVERED WITH THE FOLLOWING ACCESSORIES:		
079105667	3 inserts, hardened steel (order number for 1 unit, with 079105704)	
079105756	3 inserts, carbide (order number for 1 unit, with 079111401)	
079105668	3 short inserts, hardened steel (order number for 1 unit)	
079105669	3 long inserts in hardened steel (order number for 1 unit)	
079112126	2 inserts, adjustable for internal dia. >6mm	
079110110	Large insert holder for 3-point measurement	
079108502	IRA centering arm, Ø 15-30 mm	
079110111	Small insert holder for 3-point measurement	
079105694	Special screwdriver for IRA set	

Optional Accessories for IRA-2 Comparative Gauge

No	=
079112051	Small insert set for 3-point measurement
079112052	Long insert set pour 3-point measuring

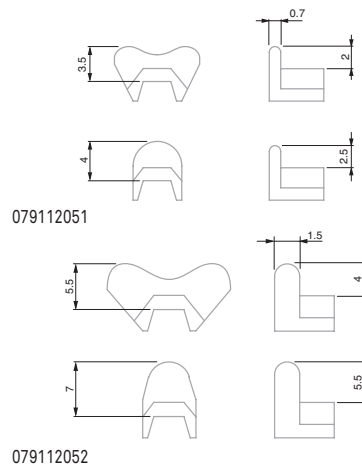
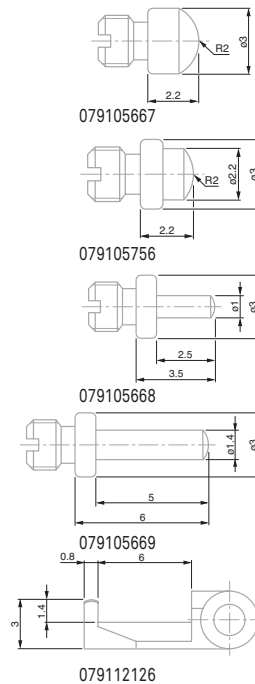
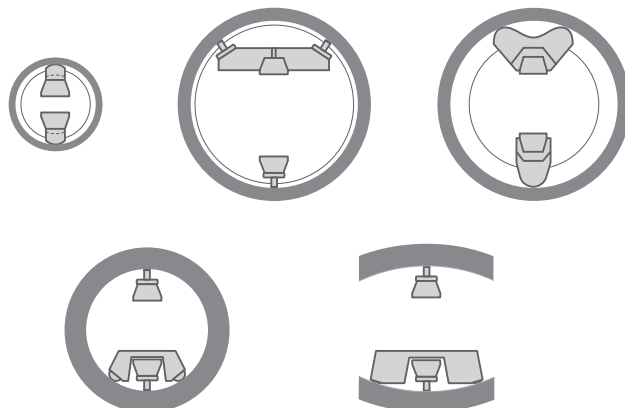

± 0,20 mm or ± 0.008 in

10 ÷ 150 mm 0.375 ÷ 6 in

0,01 mm or 0.0005 in

Measuring inserts in hardened steel or tungsten carbide, see opposite table

3,5 N

Measuring arm clearance travel: 10 mm



Chrome plated, hardened steel

Ø 57 mm

0,2 mm

Dial gauge: 5 µm

30 mm throat depth.
Highly stable frame with heat insulating handle.

≈ 2 N

Non-interchangeable measuring inserts. With device for retraction of inserts.

THICKNESS GAUGES

Designed for the direct measurement of thickness of all types of materials: plastics, glass, wood, felt, paper, rubber, etc.

Each gauge is equipped with a rotating dial for zero setting.

Model for Sheets



074115664	Thickness gauge for sheets	0 ÷ 1	0,001	Ø 6,35

Ø 57 mm

10 mm

Dial gauge: 40 µm

Interchangeable measuring inserts

Models with Open Inserts When Not in Use



074115604	0 ÷ 30	0,1	50	flat; Ø 30	074115686
074115605	0 ÷ 30	0,1	50	flat; Ø 20	074115687
074115606	0 ÷ 30	0,1	50	flat; Ø 10	074115726
074115607	0 ÷ 30	0,1	50	convex; Ø 10	074115727
074115608	0 ÷ 30	0,1	50	spherical; Ø 5	074115728



INTERAPID SHE.30 & SHE.35 SMALL HORIZONTAL MEASURING BENCHES

Extremely practical and very precise, these measuring benches are mainly used for the inspection of batches of precision parts as used in the watch making and precision mechanical sectors – Rapid measuring and easy setting from one part to the other – Wide choice of measuring inserts specially designed for the most varied of metrology applications.

INTERAPID SHE.30 for External Dimensions



0 to 30 mm



Accuracy is usually influenced by the measuring instrument used as well as both flatness and parallelism of the measuring faces of inserts.

Holder precision: Flatness tolerance of two clamping faces: 0,05 mm. Axial positioning tolerance for the two indexing pins with respect to bolt axis: 0,05 mm. Tolerance for the parallelism of the table surface with respect to the bolt axis: 0,05 mm. See drawing



Main body in cast iron. Other parts in steel, hardened and ground



Produced by sensor used. The SHE.30 model is not spring-loaded.



Mobile measuring bolt: guided on a smooth bearing surface and equipped with a semi-circular disc for bolt retraction. Measuring inserts, assembled in pairs, and mounted on the measuring bolt and fixed anvil with a 1 mm diameter pin and 2 M1,4 screws. Support table with possibility of vertical and longitudinal adjustment: Surface 24 x 9,5 mm. Adjustment range: vertical: 15 mm, longitudinal: 14 mm. With fixing screw. Sensor (not included in the supply for SHE 30 bench): electronic indicator, mechanical or precision dial gauge, axial analogue or digital probe with mounting shank of $\varnothing 8$ mm



2,1 kg



03330004 INTERAPID SHE 30 small measuring horizontal bench for external dimensions (without measuring inserts)

OPTIONAL ACCESSORY:

03360300 Measuring inserts, carbide, length 3,5 mm, height 0,4 mm

Measuring inserts, either cylindrical or knife-edged are available on request.

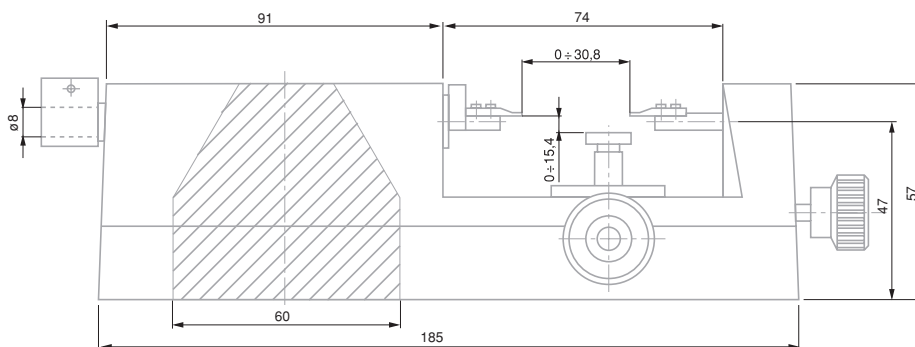

Pair of Measuring Inserts in Special Version

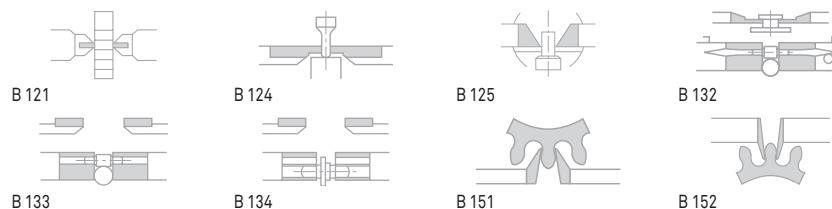

INTERAPID SHE.35 for Internal Dimensions



30 mm



8 to 38 mm (standard accessory)

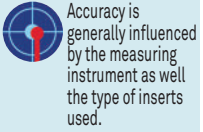

Accuracy is generally influenced by the measuring instrument as well as the type of inserts used.



Main body in cast iron. Other parts in hardened and ground steel. Inserts with carbide measuring faces.



Produced by sensor used. The SHE.35 bench is not equipped with a spring.



Mobile measuring bolt guided on a flat bearing surface, also fitted with a retracting ball-shaped handle. Interchangeable measuring inserts supplied in pairs. Fixing shaft \varnothing 4 mm. Height adjustable support table. Surface: 40 x 70 mm. Setting range: 8 mm. 1 tightening screw. Sensor (must be ordered separately), e.g. dial gauge, electronic or precision indicator, analogue or digital probe. Mounting \varnothing 8 mm.



2,3 kg



03330006 INTERAPID SHE 35 small horizontal measuring bench for internal dimensions (with measuring inserts)

8 ÷ 38 mm

Inserts with special design also available on request

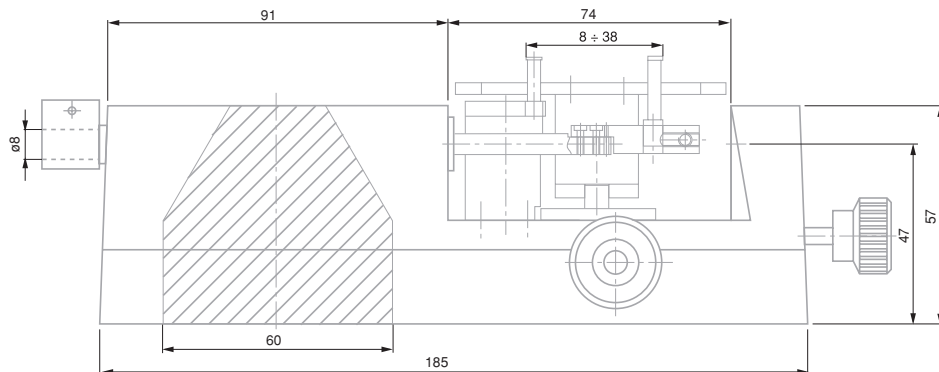









Measuring Supports and Auxiliary Equipment



TESA measuring supports have been designed to offer the best holding stability for instruments such as dial gauges, lever dial test indicators and probes. Stability is the prime requirement needed to reduce the related uncertainties in a measurement method or set-up.



-  Base with vee recess and 1 magnetic flat face. Disengageable of magnet possible. Duralumin articulations.
-  Dovetail clamp with a Ø 8 mm clamping bore
-  0,4 kg
-  Supplied without measuring instrument

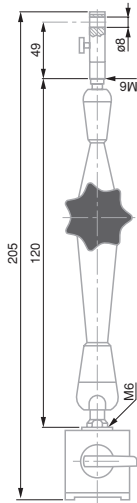



UNIVERSAL SUPPORTS



Magnetic measuring support with suction base or articulated arm.

INTERRAPID Magnetic Support with Articulated Arm (small)



Magnetic support with articulated arm

No	=							
		N	H mm	L mm	Base mm	Consisting of:		
01639025	Small magnetic measuring stand with articulated arm	≈ 170	205	120	30 x 30 x 30	- 1 articulated arm length 120 mm - 1 dovetail clamp with fine adjustment - 1 magnetic base 30 x 30 x 30 (L x W x H)		

-  Magnetic base has 1 prismatic and 2 flat faces. Articulations made from duralumin. Disengageable permanent magnet. Dovetail clamp with a Ø 8 mm clamping bore.
-  Supplied without measuring instrument

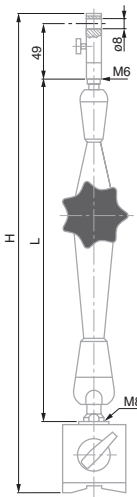

INTERRAPID Magnetic Support with Articulated Arm

Simple and secure locking using a single rotating knob
 - highly rigid arm and articulation.



Magnetic support with articulated arm

No	=								
		N	V-Base for Ø, mm	Fine adjust	H mm	L mm	Base mm	Mass kg	Consisting of:
01639022	INTERRAPID magnetic support with articulated arm	≈ 800	30 ÷ 150	●	310	200	60 x 50 x 55	1,45	- Articulated arm - Clamp - Magnetic base
01639023	INTERRAPID magnetic support with articulated arm	≈ 800	30 ÷ 150	●	390	280	60 x 50 x 55	1,85	- Articulated arm - Clamp - Magnetic base



INTERAPID Magnetic Support with High Precision Articulated Arm

Magnetic support with high precision articulated arm and fine adjustment for measurements that need repeatability in the range of μm .

Simple and secure locking with a two-position knob. Highly rigid arm and articulation.



Magnetic support with high precision articulated arm

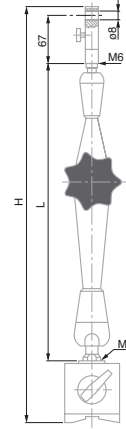

A Magnetic base has 1 prismatic and 2 flat faces. Articulations made from duralumin. Disengageable permanent magnet. Dovetail clamp with a $\varnothing 8$ mm clamping bore.

B Supplied without measuring instrument

No	=							
		N	V-Base for \varnothing , mm	Fine adjust	H mm	L mm	Base mm	Consisting of:
01639053	INTERAPID High Precision Magnetic Support with Articulated Arm	≈ 1000	$30 \div 150$	●	440	320	73 x 50 x 55	<ul style="list-style-type: none"> - Articulated Arm - Clamp - Magnetic base

INTERAPID Magnetic Support with Flexible Arm

For measurements in hard to reach locations. Instant and reliable locking through lever control.

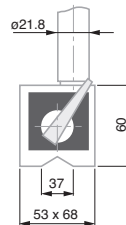

B Holding force on a flat surface ≈ 1000 N

A The magnetic base has 1 prismatic and 2 flat faces. Disengageable permanent magnet. Full length 350 mm. Dovetail clamp with an $\varnothing 8$ mm clamping bore.

B Supplied without measuring instrument

No	=	
01639020	Magnetic Support with Flexible Arm	

- Switchable magnet. Clamp with \varnothing 8 mm clamping bore
- Supplied without measuring instrument

INTERAPID Inclinable Magnetic Support

Standard model and models with strong holding force



01639017



01639019

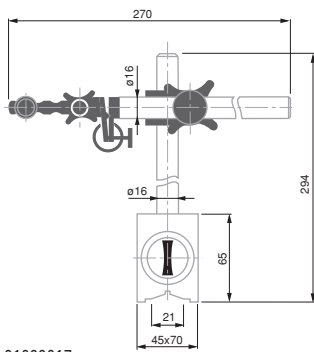

01639017

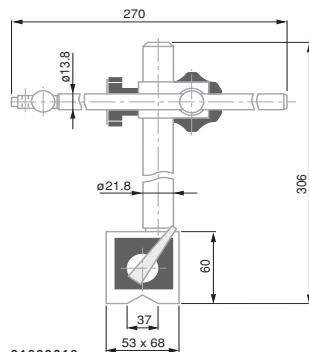

01639018

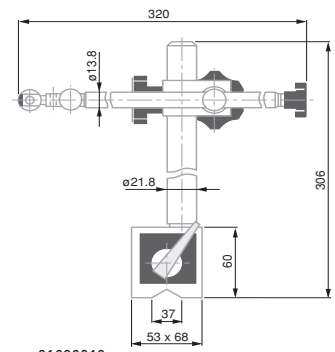

01639019

No		N	V-Base for \varnothing , mm		Fine adjust
01639017	INTERAPID magnetic support with V-base, 600 N	≈ 600	70 ÷ 220	Standard Version	●
01639018	INTERAPID magnetic support with V-base, 1000 N	≈ 1000	70 ÷ 220	Strong magnetic holding force	—
01639019	INTERAPID magnetic support with V-base, 1000 N	≈ 1000	70 ÷ 220	Strong magnetic holding force	●



INTERAPID Support with Suction Base and Articulated Arm

Holds firmly on any smooth and flat surface

- Clamps instantly and reliably using a suction lever switch.
- Highly rigid articulated arm.
- Free from magnetic fields.

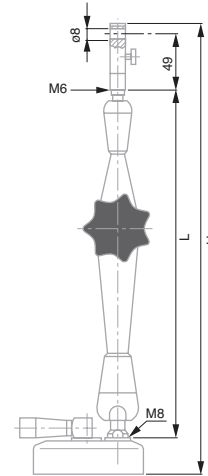

A Round suction base made of aluminium (Ø 88 mm, height 28 mm) with flat suction base. Articulations made from duralumin. Suction controlled by lever switch. Dovetail clamp with an Ø 8 mm clamping bore.

B 1.1 kg

C Supplied without measuring instrument

No	=		N		H, mm	L, mm	Consisting of:
01639024	INTERAPID Measuring support with suction base and articulated arm	≈ 400	●	363	280	<ul style="list-style-type: none"> - Articulated arm - Fine adjust clamp - Round suction base 	



Measuring table and column in hardened steel.

A Measuring arm with $\varnothing 8$ mm clamping bore, without fine adjustment. Measuring span: 48 mm.

2,7 kg

Supplied without measuring instrument

INTERAPID Small Measuring Support and Table $\varnothing 49$ mm

Round steel measuring table

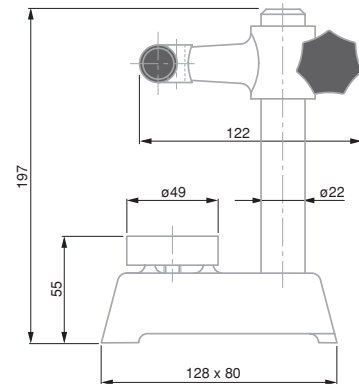

Application example with DIGICO indicator

No

=

mm
0 ÷ 100

mm
49

01639006 INTERAPID small support with $\varnothing 49$ mm measuring table

Cast iron base

A Base with front support face. Clamp for $\varnothing 8$ mm mounting rod or dial gauge with lug back. Model No 01639003 also with dovetail clamp.

1,3 kg (01639003)
4,35 kg (01639004)

Supplied without measuring instrument

INTERAPID Measuring Support with Inclined Frontal Arm



01639003

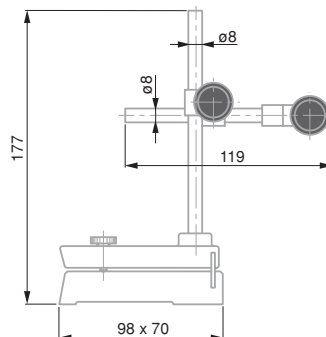

01939003



01639004

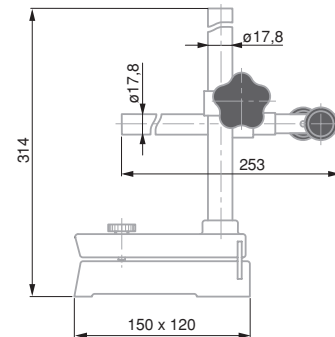

01939004

No

=

Used in conjunction with:
Lever dial test indicators, small dial gauges

01639003 INTERAPID Measuring Support with Inclined Frontal Arm H = 177 mm

01639004 INTERAPID Measuring Support with Inclined Frontal Arm H = 314 mm

Lever dial test indicators, small dial gauges, precision indicators, probes etc.



INTERAPID UA 1 Table Measuring Support with Ground Table Surface

Basic model without fine adjustment

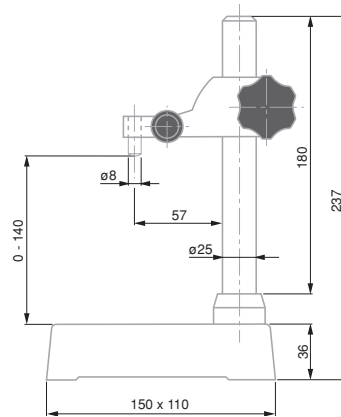

01639008	INTERAPID UA 1 measuring support with table	0 ÷ 140	100 x 100

Measuring table: cast iron. Column: chrome-plated steel, Arm: spheroidal graphite cast iron.

Measuring surface of table: ground. Column: Can be dismantled. Measuring arm with Ø 8 mm clamp.

3 kg

Supplied without measuring instrument

INTERAPID UD12 Support

Medium sized mobile measuring support for use with ever type dial test indicators, dial gauges, precision indicators, electronic probes etc.

With fine adjustment mechanism.

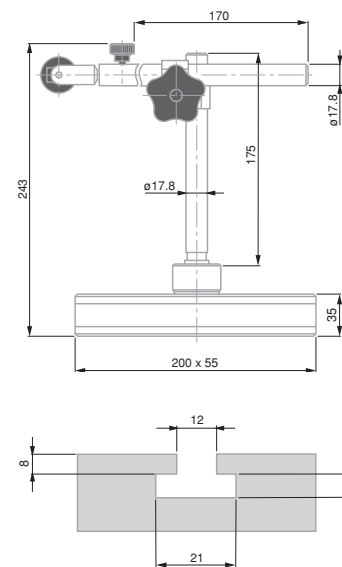

01639000	UD 12 universal support		
COMPOSÉ DE:			
01840105	Tige de fixation à queue d'aronde Ø 8 mm		
01640100	UDZ 3 Mounting rod and UDZ3 clamp Ø 8 mm clamp for UD 12		

Cast iron base

Stand with lateral guiding faces. T-slot for vertical column. 2 rigid articulations

3.3 kg

Supplied without measuring instrument

INTERRAPID Table Measuring Stands with Granite Grade 00

3 µm in accordance with DIN 876 T1, class 00

01639035: black burnished column with Ø 8 mm clamping bore.

01639029: chrome plated column with thread and threaded ring for adjusting the height of the measuring arm. Ø 8 mm clamping bore. Grooved measuring face.

01639033: Chrome plated column. Horizontal sliding arm. Ø 4 mm or 8 mm bore for a dovetail clamp or lug.

Supplied without measuring instrument

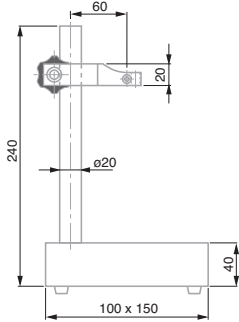

01639035

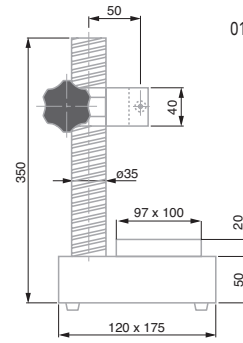

01639029

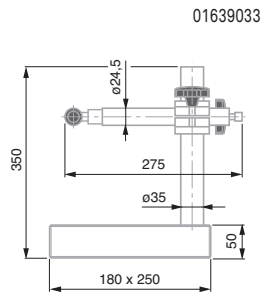

01639033



No	=									
		mm	mm	Measuring surface	Fine adjustment	Measuring table mm	Column height mm	Working surface mm	Span mm	kg
01639035	Table measuring support with granite, column Ø 20	0 ÷ 170	20	Granite	–	100 x 150 x 40	200	100 x 115	50,0	2,6
01639029	Slotted table measuring support with granite, threaded column Ø 35	0 ÷ 225	35	Hardened steel	●	120 x 175 x 50	300	100 x 100	68,5	8,1
01639033	Table measuring support with granite, column Ø 35	0 ÷ 260	35	Granite	●	180 x 250 x 50	300	180 x 200	Adjustable	10,5



SMALL MAGNETIC SUPPORTS

Ideal for lever type dial test indicators, and dial gauges up to 40 mm diameter
- With 2 articulation joints and fine adjustment.

Small magnetic support UJ 15

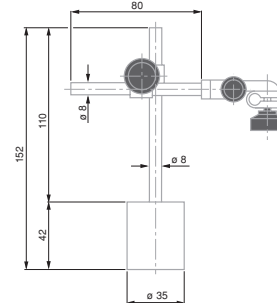

01639007 + 01640501
with dial test indicator



01639007 Magnetic support INTERAPID UJ15, dovetail clamp and $\varnothing 8$ mm cylindrical clamping

Small magnetic support UJ 15G

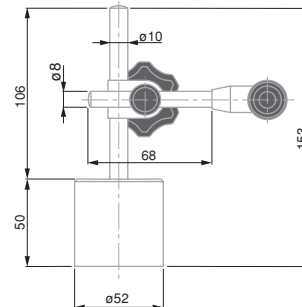

01639016 UJ Magnetic support

Accessories for Small Magnetic Stands



01640501 Steel base plate for UJ15 or UJ15G that become movable

Holding force on a flat surface: ≈ 220 N

Rounded base with permanent magnet

0,47 kg

Supplied without measuring instrument

Holding force on a flat surface: ≥ 350 N

Rounded base with permanent magnet

0,93 kg

Supplied without measuring instrument

50 x 80 x 20 mm

0,60 kg

Cast iron table.
Chrome plated steel column

Support base:
Ground measuring face. 2 T-slots. Removable column.

Supplied without measuring instrument

Support base only: 4,85 kg
Measuring arm: 0,85 kg
Sliding arm: 1,75 kg

UA 30 MEASURING STAND

Base for mounting special fixtures adapted for series inspection

INTERAPID UA 30 Measuring Stand, Without Measuring Arm

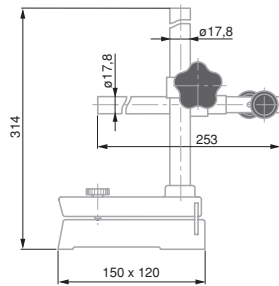

01639009

INTERAPID UA 30 measuring support with table, without measuring arm

0 ÷ 175

0 ÷ 6.89

125 x 115

Measuring arm 01610200: With fine adjustment. 1 mm travel. \varnothing 8 mm clamping bore. Sliding arm 01610201: Sliding holder for TESA YA dial gauges. Adjustable swinging movement. Clamping bore \varnothing 13 mm. Length of travel 35, 57 or 80 mm. Measuring span 60 mm. Depth stop plate 01640000: Dimensions: 115 x 35 x 3,5 mm. 120° vee recess for \varnothing \leq 120 mm, 2 tightening screws.

Accessories for UA 30

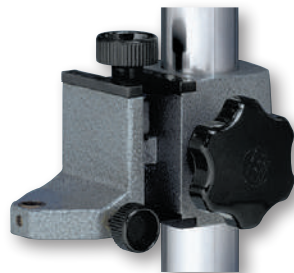

01610200



01610201

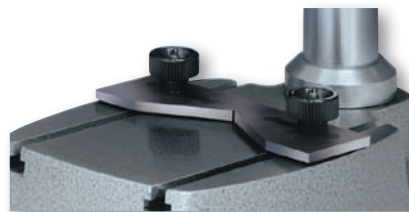

01640000



01610200

UK 20 measuring arm with fine adjustment for UA30 support

01610201

UK 25 sliding arm. Used with TESA YA for stationary bore measurement on UA30 support

01640000

UAZ 10 depth stop plate for UA 30



EQUIPEMENT AUXILIAIRES

INTERAPID Depth Foot with a Flat Face



No	=						
01639046	Depth foot with flat face	mm		80 x 16		8	

- Hardened steel
- Lapped measuring faces. Clamp with lock for mounting a dial gauge or probe
- Supplied without measuring instrument

INTERAPID Depth Foot with Prismatic Measuring Face

For measuring the depth of key slots on cylindrical shafts and determining circularity errors etc.



No	=						
01639047	Depth foot with prismatic measuring face	Diameter mm	Diameter in	Width mm	Width in	Clamp mm	Clamp in
		10 ÷ 100	0.39 ÷ 3.9	16	0.64	8	0.315

- Hardened steel
- Lapped measuring faces. Clamp with lock for mounting a dial gauge or probe
- Supplied without measuring instrument

Brown & Sharpe CENTER FINDER Centering Tool

Practical for aligning the centre of a bore with respect to the spindle axis of a machine tool

- Without the clamping shaft, it can also serve as small magnetic support
- Allows the clamping of a dial test indicator, either a standard or perpendicular model.



No	=
06769006	B&S CENTER FINDER centering tool

- Center Finder consisting of the following components:
 - cylindrical shank for clamping on the chuck of a machine tool.
 - powerful round magnetic base with strong holding capacity.
 - swivel joint and dovetail collar for clamping a lever-type dial test indicator.

- Hardened steel
- Ground finish for support and vee faces
- Not available as individual components

Brown & Sharpe V-Block Set with Clamping Bridge

V-blocks with frames for clamping cylindrical parts diameters ranging from 0,7 to 40 mm.

Can be used for machining or inspecting workpieces

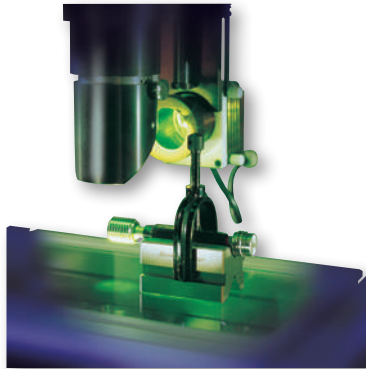

No	=	∅	∅		Consisting of:	
		Clamping Range, mm	Clamping Range, in			
06769007	Set of B&S V-blocks	0,7 ÷ 40	0.3 ÷ 9/32		1 pair of V-blocks	5 ÷ 40 mm
					1 extra V-block	3 ÷ 8 mm
					1 extra V-block	1,5 ÷ 5 mm
					5 extra V-blocks	0,7 ÷ 3,5 mm
					2 in-between bridges	
					2 large frames	
					1 small frame	

- 7 µm for each pair
- 2,5 µm for the 6 faces
- Hardened steel, 55 to 60 HRC
- Each block has 18 through bores ∅ 9,53 mm and 5 bores with M10 threads
- Supplied with five M10 socket head screws and one 8 mm socket wrench

Brown & Sharpe Positioning Block Set

Pair of matched blocks used for positioning and holding workpieces or for use as stops on granite surface plates, a coordinate measuring set-up, a machine-tool or other applications - Each block are precision ground.

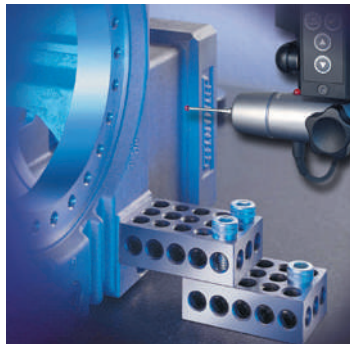

No	=		
		mm	in
06769004	Positioning block set, precision ground	75 x 50 x 25	2.95 x 1.95 x 0.98



Brown & Sharpe Adjustable Parallels

Set consists of 6 adjustable parallels.

Used as parallel pads, setting standards for measuring instruments or gauges for checking internal dimensions on parallel surfaces.

Each parallel consists of two tapered parts dovetailed together. – Two tightening screws lock the parallels to the size required.

- Hardened steel
- Supplied with a PH 1 screwdriver

06769010	Adjustable parallel set			
Consisting of:				
	Height mm	Length mm	Width mm	
1 parallel	10 ÷ 13	44	7	
1 parallel	13 ÷ 17	54	7	
1 parallel	17 ÷ 24	68	7	
1 parallel	24 ÷ 33	90	7	
1 parallel	33 ÷ 44	106	7	
1 parallel	44 ÷ 57	129	7	



ROCH Flexible Rules

In spring stainless steel - Divisions of 1 mm and 0.5 mm.

- Class CE II
- Stainless spring-loaded steel



		Length mm	Width mm	Thickness mm
0951750181	ROCH flexible rule L = 200 mm		200	13
0951750182	ROCH flexible rule L = 300 mm		300	13
0951750184	ROCH flexible rule L = 500 mm		500	18
0951750187	ROCH flexible rule L = 1000 mm		1000	18

Length L = 100 mm,
Width = 13 mm max.

Alloyed steel

Blades not supplied individually

ROCH Thickness Gauges



No	=				
		Thickness mm	Step mm	Thickness in	Number of blades
0951753013	ROCH thickness gauge with 13 blades, 0,05 to 1,0 mm	0,05 ÷ 0,3 / 0,4 ÷ 1,0	0,05 / 0,1	0.001968 ÷ 0.003937	6/7
0951753014	ROCH thickness gauge with 20 blades: 0,05 to 1,0 mm	0,05 ÷ 1,0	0,05	0.001968 ÷ 0.003937	20
0951753015	ROCH thickness gauge with 21 blades; 0,1 to 0,2 mm	0,1 ÷ 2,0	0,1 + 1 x 0,05	0.003937 ÷ 0.07874	21

Stainless steel

Blades are not supplied individually

ROCH Radius Gauges

Set of radius gauges with concave and convex blades.
Designed for visual inspection of radii.



No	=				
		Radius mm	Radii mm	Step mm	Number of blades
0951753001	ROCH radius gauge 2 x 17 blades	0,1	1,0 ÷ 2,75 / 3,0 ÷ 7,0	0,25 / 0,5	2 x 17
0951753002	ROCH radius gauge 2 x 16 blades	0,15	7,5 ÷ 15,0	0,5	2 x 16
0951753003	ROCH radius gauge 2 x 15 blades	0,2	15,5 ÷ 19,5 / 20,0 ÷ 25,0	0,2	2 x 15

Alloyed steel

Blades are not supplied individually

ROCH Screw Pitch Gauges

60° flank angles for ISO metric threads
or 55° for Whitworth threads.



No	=			
		Thread pitch mm	Threads per in	Metric thread
0951753045	ROCH screw pitch gauge for ISO 60° threads	0,25 / 0,3 / 0,35 / 0,4 / 0,45 / 0,5 / 0,6 / 0,7 / 0,75 / 0,8 / 0,9 / 1,0 / 1,25 / 1,5 / 1,75 / 2,0 / 2,5 / 3,0 / 3,5 / 4,0 / 4,5 / 5,0 / 5,5 / 6,0	-	ISO 60° mm
0951753046	ROCH screw pitch gauge - Whitworth 55° threads	-	62 / 60 / 48 / 40 / 36 / 32 / 30 / 28 / 26 / 25 / 24 / 22 / 20 / 19 / 18 / 16 / 14 / 13 / 12 / 11 / 10 / 8 / 7 / 6 / 5 / 4,5 / 4	Whitworth 55° (threads per inch)





ROCH Portable Magnifier

With a folding handle and additional magnifier. – Retractable support.

 Solid resistant plastic



					
		Large magnifier	Small magnifier	mm	Small magnifier, mm
0951754511	ROCH portable magnifier	3x	10x	80 x 45	13



Straightness, Angle and Inclination Measurement



INCLINOMETERS AND PRECISION LEVELS

Irrespective of whether they are spirit or electronic inclinometers, all precision levels are based on the same perfectly reliable reference but also cost-free: the centre of the earth's gravity.

Under the force of gravity, the gas bubble in the liquid or the pendulum inclines itself according to this natural physical principle.

The position of the pendulum with respect to the measuring faces of the instrument body can then be measured. Based on this perfect principle, these instruments offer a great number of measuring applications of high precision. The horizontal and vertical positioning of the measuring faces enable the detection of form errors in the geometrical elements on the workpiece to be measured.

These errors often result from deviations in straightness, flatness, position, parallelism and squareness.

Indication of values may vary depending on the type of level, the values typically displayed are:

- inclination (mm/m or in/10 in);
- radian in mrad;
- decimal angle (e.g. 12,37°);
- sexagesimal angle in degrees (°), minutes (') and seconds (") e.g. 15° 30' 45".



TESA MICROBEVEL 1



TESA CLINOBEVEL
1 USB



TESA CLINOBEVEL 2



TESA NIVELTRONIC



Spirit clinometers with
angle protractor



- DIN 2276 Part 2 (Form D)
- LCD angle display: Decimal or sexagesimal
- Inclinometer
- mm/m, in/10 or 12 in, mm or in/basis length, radian (mrad) and the like
- Capacitive measuring system with gravity pendulum
- 2' + 1 numerical interval
- 21 storable correction values (high accuracy)
- Flat face 4 x 90°
- 100 x 75 x 35 mm
- Anodised light alloy
- Response time ≈ 1 s
- Automatic shut down after 8 min
- Display lock
- RS485, asynchronous, 7 bits, 2 stop bits, no parity, 9600 bauds
- 1 1,5 V battery, type LRC 6, AA
- ≈ 150 hours
- IP65 (IEC 60529)
- EN 50081-1 / -2
EN 50082-1 / -2
- 0,52 kg
- Inspection report with declaration of conformity

INCLINOMETERS AND LEVELS

The TESA inclinometers and levels meet the most demanding applications not only in the machine building sector but also in the civil construction sector.

Electronic Inclinometer - TESA CLINOBEVEL 1 USB

Compact universal instrument for direct and differential measurements – Measuring range $\pm 45^\circ$ with display of measured angles or inclinations – Reinforced aluminium housing, eloxide surface – Large digital display for error free interpretation of readings.

Supplied with CLINOSOFT software permitting the visualisation and storage of measurements as well as the USB cable to host computer.

Multiple applications are possible, notably the measurement of 2 flat surfaces by comparing the measured values with the help of 2 instruments. Automatic generation of inspection reports using Microsoft EXCEL spreadsheet software.

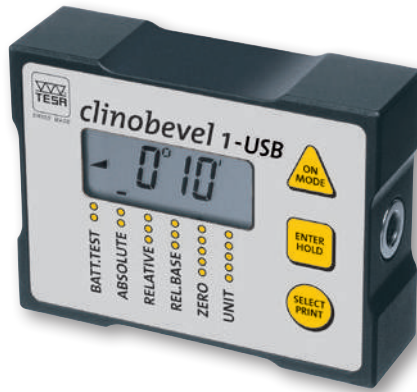

CLINOSOFT Software



Measuring functions: A ; B ; A+B ; A-B



CLINOSOFT Software

CLINOBEVEL 1-USB, can be used on its 4 faces.

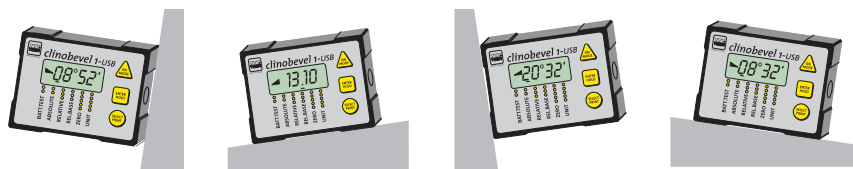

					Livré avec:
05330203	CLINOBEVEL 1 USB electronic inclinometer	$\pm 45^\circ$	$\geq 0,02$	100 x 75 x 35	CLINOSOFT software plus USB cable to host computer
OPTIONAL ACCESSORIES:					
04768002	4 batteries LRC 6 AA, 1,5 V for CLINOBEVEL 1 USB, CLINOBEVEL 2, MICROBEVEL,				
05360006	External switch with cable, L = 2 m, for CLINOBEVEL 1 USB				
05360014	External switch, wireless, for CLINOBEVEL 1 USB				



TESA CLINOBEVEL 2 Electronic Inclinometer

Portable precision inclinometer.

- Measuring range $\pm 45^\circ$ with indication of angle or inclination.
- Integrated temperature compensation 2 prismatic measuring faces.
- Spirit level integrated in transverse direction to eliminate "twist" error.
- Simple and rapid calibration: correction of gain by the 3-point method and software integrated in the instrument.
- Microprocessor-based features for display setting and instrument adjustment.

The CLINOBEVEL 2 can be used on its two reference faces. It can also be connected to a second CLINOBEVEL 2 instrument for a differential measurement (Comparative): one of the two instruments operates as a reference without the need to connect to a computer. The integrated RS 232 interface enables the connection of the instrument to a computer. Magnetic inserts can be integrated on the measuring faces on request as a special execution.

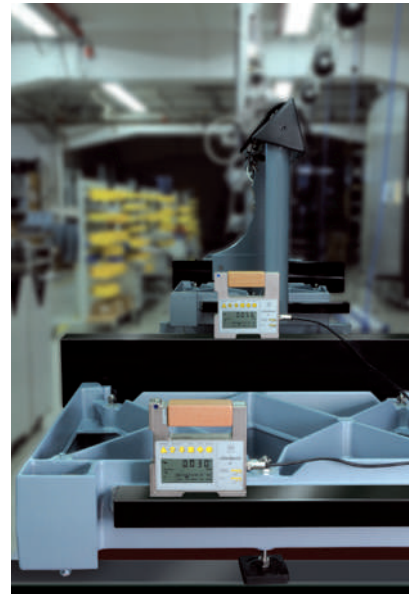

When 2 CLINOBEVEL 2 are connected, one of the instruments becomes the reference

- DIN 2276 Part 2 (Form D)
- LCD angle display: Decimal or sexagesimal Inclination mm/m, in/10 or 12 in, mm or in/ basis length, radian (mrad) and the like
- Capacitive measuring system with gravity pendulum
- $10'' + 0,03\%$ of the readout
- 2 flat measuring faces with V-slot for diameters from $\varnothing 17$ to 94 mm
- 150 x 150 x 35 mm
- Rust inhibiting housing
- Response time: < 5 s
- Automatic shut down after 8 min
- RS 232 asynchronous. 7 bits, 2 stop bits, no parity, 9600 bauds
- 2 batteries 1,5 V, type LRC 6, AA
- 40 to 60 hours
- IP65 (IEC 60529)
- EN 50081-1 / -2 EN 50082-1 / -2
- 3 kg

05330202	Electronic Inclinometer TESA CLINOBEVEL 2	$\pm 45^\circ$	$\geq 5''$ (5 Arcsec = 0,025 mm/mm)	mm 100 x 150 x 35
OPTIONAL ACCESSORIES:				
04768002	4 batteries LRC 6 AA, 1,5 V for CLINOBEVEL 1 USB, CLINOBEVEL 2, MICROBEVEL,			
05360004	Connecting cable between 2 CLINOBEVEL 2, L = 2,5 m			
S53070174	Câble USB pour CLINOBEVEL 2, L=2,5 m			

- DIN 2276 Part 2 (Style D)
- See table for max. perm. errors
- LCD display according to table
- Fully encapsulated measuring system with gravity pendulum
- See table for max. perm. errors
- 2 flat measuring faces with V-slot for diameters from 20 to 120 mm
- Cast iron base. Chromium plated side faces. Aluminium housing, lacquered
- Response time < 3 s
- Automatic shut down after 55 min
- 1 mV per unit (100 kΩ)
- 1,5 V battery, type LRC 6, AA
- 100 to 140 hours
- ≤ 0,1 %/°C based on the measuring range at 20 ± 5°C
- EN 50081-1 / -2 EN 50082-1 / -2

TESA MICROBEVEL 1 Inclinometer

TESA MICROBEVEL 1 is particularly suited for measuring slightly inclined surfaces such as the measuring of flatness of surfaces or the geometrical characteristics (deviation, rotation etc.) of a machine tool.

Suited for operation under the most rugged conditions., protected by an aluminium case.

Power supplied by a single standard battery AA 1,5 V for at least 100 hours of operation.



Horizontal model



Square model

Models with steps 0,05 to 0,005 mm/m available on request

No	=				
		Range 1 or Range 2, mm/m	Base width, mm	Base height, mm	kg (with transport case)
05330003	TESA MICROBEVEL 1 horizontal base 110 x 45 mm	0,01 ou 0,001	110	45	1,8
05330004	TESA MICROBEVEL 1 horizontal base 150 x 45 mm	0,01 ou 0,001	150	45	2,1
05330005	TESA MICROBEVEL 1 square base 150 x 45 mm	0,01 ou 0,001	150	45	3,1

OPTIONAL ACCESSORY:

04768002 4 batteries LRC 6 AA, 1,5 V for CLINOBEVEL 1 USB, CLINOBEVEL 2, MICROBEVEL,

Range	mm/m	mm/m	mm	G = mm/m		
1	± 20	± 5	0,01	Flatness ≤ 5 mm/m G = 1 % of the measured value and min. 0,01 mm/m	Flatness > 5 mm/m G = 0,01 mm/m	
2	± 2	± 2	0,001	Flatness ≤ 1 mm/m G = 1 % of the measured value and min. 0,001 mm/m	Flatness > 1 mm/m G = 1 % of (2x measured value -1)	



TESA NIVELTRONIC Electronic Levels with Analogue Display and Integrated Galvanometer

Electronic levels with analogue display and integrated galvanometer.

These instruments are known for a remarkable stability at zero point. They are used for the inspection and alignment of horizontal and vertical surfaces. They are also suitable for the measurement of slight inclinations, specially for the inspection of flatness of granite surface plates.

The square model is particularly suited for the measurement of flat or cylindrical parts thanks to its prismatic base.



NIVELTRONIC square model with 2 prismatic bases



NIVELTRONIC horizontal model with flat base



NIVELTRONIC horizontal with granite base

- DIN 2276 Part 2 (Style D)
- See table
- Inductive measuring system with gravity pendulum
- As per DIN 2276: up to 0,5 * measuring range: min. 0,001 mm/m, max. 1 % of the measured value from 0,5 * measuring range: max. 1 % of (2 * measured value - 0,5 * total range.)
- 1 µm/m
- Horizontal model with a flat measuring face. Square model with 2 flat faces having a V-slot for Ø from 20 to 120 mm
- Cast iron body. Horizontal model with granite base.
- ≈ ± 0,2 V, impedance 4,5 kΩ
- 4 batteries AAA 1,5 V
- EN 50081-1 / -2 EN 50082-1 / -2



No	=				
		mm/m	Base length mm	Base width mm	kg
03130063	TESA NIVELTRONIC electronic level, horizontal, analogue display	0,05 / 0,01	150	45	6,0 / 3,7 *
03130060	TESA NIVELTRONIC electronic level, square, analogue display	0,05 / 0,01	200	45	6,5 / 4,4 *

* With/without wooden case

OPTIONAL ACCESSORIES:

03160007	Granite base 200 x 50 mm for horizontal NIVELTRONIC**
03160008	Granite base 250 x 50 mm for horizontal NIVELTRONIC**
03160009	Granite base 500 x 50 mm for horizontal NIVELTRONIC**
03160048	Holder with voltage regulator (4,65 V) and 4x LR03 AAA for NIVELTRONIC
04761059	4 batteries LR03 AAA, 1,5 V for NIVELTRONIC

		"		"
1	± 0,75	± 150"	0,05	10"
2	± 0,15	± 30"	0,01	2"

DIN 2276/1 (instrument) DIN 877 (graduation)

DIN 2276/1

Mounting with 2 or 3 screws

TESA Crossed Spirit Levels – for Assembly

For the inspection and alignment of flat surfaces.

The 2 vials permit a simultaneous alignment in the X and Y axes.
The level can be screwed on to a surface.



Model B: Circular level with cross vials, 3-point mounting. Aluminium alloy protection case, anodised.



Model C: T-shaped level with cross vials, 2-point mounting. Manually lapped measuring base to ensure a much higher precision of the level.

No		mm/m	Modele type	I x L mm	mm	H mm
05331500	Level, 2 vials, 2 to 5 mm/m, Ø 40	2 ÷ 5	B, Circular level with 2 vials, 3x M2, 35 g (level only)		Ø 40	11
05331502	Level, 2 vials. 0,3 mm/m, 0,3 Ø 60		B, Circular level with 2 vials, 3x M4, 85g (level only)		Ø 60	13
05331550	Level, 2 vials; 0,1 mm/m, 0,1 80 x 65 mm		C, T-shaped level with 2 vials, 2x M5, 250 g (level only)	80 x 65		17
05331551	Level, 2 vials; 0,3 mm/m, 0,3 80x65 mm		C, T-shaped level with 2 vials, 2x M5, 250 g (level only)	80 x 65		17



TESA Precision Spirit Levels

For checking and aligning flat or cylindrical surfaces in the horizontal position.

With an adjustment system for zero point and "twist" error.

Prismatic measuring base, manually lapped finish, enabling a higher precision for the level.

Insulating grip in wood essential for reducing heat transfer due to manual handling.

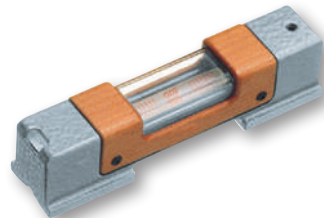

Model B: horizontal precision level

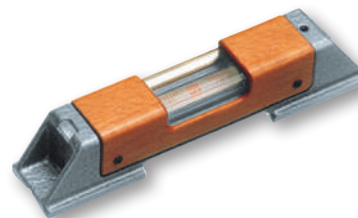

Model C: horizontal precision level

No	=		A	✳	⊥
		mm/m		For shafts Ø, mm	mm
05331050	Precision spirit level 0,02, L = 100 mm	0,02	B, 0,35 kg (level only)	17 ÷ 84	100 x 32 x 35
05331054	Precision spirit level 0,02, L = 150 mm	0,02	B, 0,65 kg (level only)	17 ÷ 94	150 x 35 x 38
05331058	Precision spirit level 0,02, L = 200 mm	0,02	C, 0,95 kg (level only)	19 ÷ 108	200 x 40 x 42
05331061	Precision spirit level 0,1, L = 200 mm	0,1	C, 0,95 kg (level only)	19 ÷ 108	200 x 40 x 42
05331063	Precision spirit level 0,02, L = 250 mm	0,02	C, 1,3 kg (level only)	19 ÷ 120	250 x 45 x 42

TESA Precision Spirit Levels with a Frame

For checking and aligning flat or cylindrical surfaces in horizontal and vertical positions.

Instrument features: 4 measuring faces, 2 prismatic faces (shafts Ø 17 to 135 mm) et 2 smooth flat faces.

With adjustment system for zero point and "twist" error.

Longitudinal vial with sensitivity of 0,02 to 0,1 mm/m, depending on the model.

Side viewing slots for an excellent visibility of the top and side of the main vial.

Cross vial with sensitivity of 2-5 mm/m for easy adjustment.

3 insulating grips to avoid any thermal transfer.

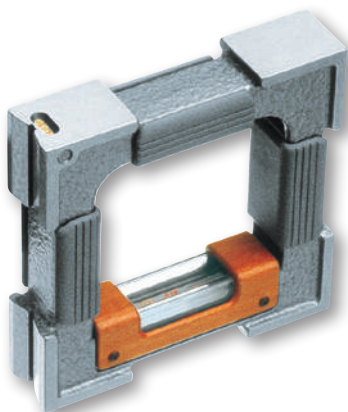

No	=		✳	⊥
		mm/m	For shafts Ø, mm	mm
05331201	Precision spirit level with frame, 0,05/100 x 100 x 32 mm	0,05	17 ÷ 84	100 x 100 x 32
05331202	Precision spirit level with frame, 0,1/100 x 100 x 32 mm	0,1	17 ÷ 84	100 x 100 x 32
05331204	Precision spirit level with frame, 0,05/150 x 150 x 35 mm	0,05	17 ÷ 94	150 x 150 x 35
05331206	Precision spirit level with frame, 0,02/200 x 200 x 40 mm	0,02	19 ÷ 108	200 x 200 x 40
05331210	Precision spirit level with frame, 0,05/250 x 250 x 45 mm	0,05	19 ÷ 120	250 x 250 x 45

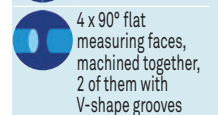
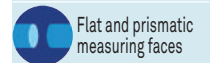



DIN 877



DIN 2276 Part 1

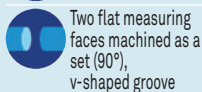

Two flat measuring faces machined as a set (90°), v-shaped groove



Longitudinal and cross vials

TESA Precision Spirit Levels, Square Models with Magnetic Inserts

For inspecting and aligning flat or cylindrical surfaces in horizontal and vertical positions.

Instrument features: 2 prismatic faces (shafts \varnothing 19 to 108 mm) with the vertical measuring face having magnetic inserts.

Equipped with an adjustment system for zero point and "twist" error.

Longitudinal vial with a sensitivity from 0,02 to 0,05 mm/m, depending on the model.

Cross vial with a sensitivity of 2-5 mm/m for an easy adjustment.

A quality wooden grip reduces thermal transfer during manual handling.

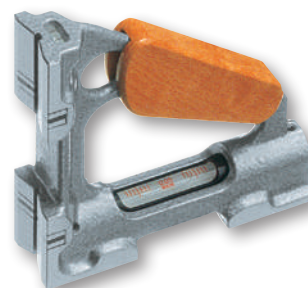

No	=			
05331000	Magnetic square level 0,02/150 x 150 x 40 mm	0,02	19 ÷ 108	150 x 150 x 40
05331002	Magnetic square level 0,05/150 x 150 x 40 mm	0,05	19 ÷ 108	150 x 150 x 40

TESA Precision Spirit Level with Micrometric Adjustment

Precision spirit level with micrometer adjustment.

For the measurement of inclinations from -20 to +4 mm/m.

1 division = 0,02 mm/m

Instrument features:

+ 1 micrometer rotation = + 2 mm/m (100 divisions)

+ 2 micrometer rotations = + 4 mm/m

- 10 micrometer rotations = - 20 mm/m

Prismatic measuring face (shafts \varnothing 19 to 120 mm).

Longitudinal vial with sensitivity of 0,02 mm/m

Cross vial with sensitivity of 2-5 mm/m for easy horizontal adjustment.

With side thermal insulators to reduce heat transfers to the instrument during manual handling.



No	=			
05331450	Precision spirit level with micrometer element 0,02 / 150 x 45 x 45 mm	0,02	19 ÷ 120	150 x 45 x 45



DIN 877



DIN 2276 Part 1

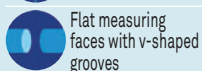

Flat measuring faces with v-shaped grooves



Hardened and ground steel



Longitudinal and cross vials



TESA Spirit Inclinometer with Protractor and Micrometer Element

Enables the measurement of angular deviations in any position of a cylindrical or flat surface.

Instrument features: prismatic measuring face (shafts \varnothing 17 to 80 mm) (DIN 877 + DIN 2276/1). Scale range: $2 \times 180^\circ$.

The adjustment is executed by disengaging the micrometer element by pressing in the direction indicated by the arrow. Afterwards the vial is oriented manually before engaging the micrometer element and executing the fine adjustment with the latter.

1 scale division = 1 degree.

1 division of the micrometer element = 1 Arcmin

Vial with sensitivity of 0,3 mm/m (= 1 Arcmin).

Error limit = 1,5 Arcmin

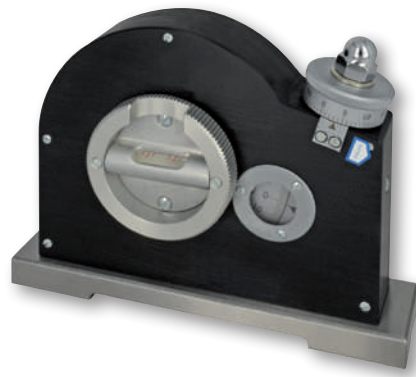

DIN 877



DIN 2276 part 1



Flat measuring faces with v-shaped groove



Hardened and ground steel base



Longitudinal and cross vials



1,6 kg (without case)
2,1 kg (with case)



Scale division of micrometer element
1 Arcmin



Scale division of level
1 Arcmin (0,30 mm/m)



$2 \times 180^\circ$



For shafts \varnothing , mm

17 ÷ 80



mm

150 x 35 x 116

05331750

Spirit clinometer with angle protractor and micrometer element



Accessories for Clinometers and Levels



04768002	4 batteries LRC 6 AA, 1,5 V for CLINOBEVEL 1 USB, CLINOBEVEL 2, MICROBEVEL,
05360006	External switch with cable, L = 2 m, for CLINOBEVEL 1 USB
05360014	External switch, wireless, for CLINOBEVEL 1 USB
05360004	Connecting cable between 2 CLINOBEVEL 2, L = 2,5 m
04761059	4 batteries LR03 AAA, 1,5 V for NIVELTRONIC
03160007	Granite base 200 x 50 mm for horizontal NIVELTRONIC
03160008	Granite base 250 x 50 mm for horizontal NIVELTRONIC
03160009	Granite base 500 x 50 mm for horizontal NIVELTRONIC
03160048	Holder with voltage regulator (4,65 V) and 4x LR03 AAA for NIVELTRONIC



FLATNESS MEASUREMENT

ROCH Bevelled Straight Edges

Models with 1 bevelled edge, with insulating grip to limit the transfer of thermal heat during manual handling for optimal precision.



Bevelled edge

No	=	⊖	⊕
		μm	mm
0951750002	Bevelled straight edge	2	75
0951750003	Bevelled straight edge	2	100
0951750005	Bevelled straight edge	3	150
0951750006	Bevelled straight edge	3	200
0951750007	Bevelled straight edge	3	300

- DIN 874 T2, NF E 11-104
- Hardened steel to ≥ 650 HV 10
- Straight edges up to 200 mm in a plastic case, ≥ 300 mm in a wooden case.

SQUARES

ROCH Flat and Try Squares in Steel – Accuracy Class 1

Try square 90° flat in stainless steel, non-hardened



No	=	⊥	A	⊕	⊖
		μm		Length of beams, mm	Section mm
0951751605	Try-square steel	15	With 90° hook	100 x 70	20 x 5
0951751607	Try-square steel	18	With 90° hook	150 x 100	28 x 6

- Factory standard
- Accuracy class 1
- Accuracy class 1
- Stainless steel, hardness 200 HRB,



- Factory standard
- Hardened steel

Brown & Sharpe Try Square Set

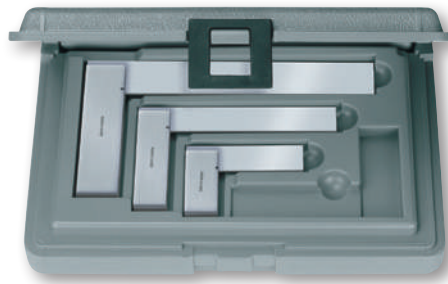

No	=		
06739001		Three square set B & S	
	=		
Consisting of:		mm	µm
1 Try square		68 x 45	16
1 Try square		120 x 70	16
1 Try square		175 x 95	16

- DIN 875 NFE 11-103
- Accuracy class 00
- Accuracy class 00
- Accuracy class 00
- Stainless steel, hardened to ≥ 550 HV 30

ROCH Bevelled Edge Squares – Accuracy Class 00

Bevelled edge 90° squares in stainless steel, hardened



No	=			
		µm	Length of beams, mm	Section of beams mm
0951751533		3	50 x 40	14 x 4,5
0951751534		3	75 x 50	16 x 4
0951751535		3	100 x 70	20 x 5



ANGLE PROTRACTORS

Angle Protractor with Digital Display

Measuring ranges 1x 360°, 2x 180°, 4x 90°

Large decimal or sexagesimal display

2 measuring directions

Fine setting with adjustment screw

Locking system

Scale L = 200 mm (300 or 500 mm available as options)

RS232 data output

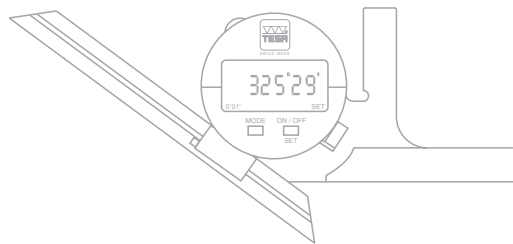

00630010 Angle protractor with digital display. Supplied with a scale of L = 200 mm

OPTIONAL ACCESSORIES:

00660004 Scale 200 mm

00660005 Scale 300 mm

00660006 Scale 500 mm

00660007 Supporting base with 1 flat measuring face and 1 prismatic measuring face

00660008 Square for measuring sharp angles

01961000 Lithium battery, 3V, CR 2032

04761062 Opto-USB cable, duplex, bidirectional communication

- Measuring ranges:
1 x 360°, 2 x 180°,
4 x 90°
- LCD, 5 digits + sign
- 0,01° / 1 minute
of arc
- 8,5 mm
- Max. perm. error.: 4
minutes of arc
- Stainless steel body,
hardened
- Maximum rotation
speed.: 1080°/s
- Preset to 0° or 180°
- RS232 opto-coupled
- 1x CR2032 3,0V
- 5000 hours
- IP51 (CEI 529)
- 410 g
- Wooden case (ISPM
15 andt NIPM 15)



- 2 circular scales
- Main scale: 5'.
Double numbering in opposite directions.
Auxiliary scale: 10°
- Max. perm. error: 5' (without accessory)
- Hardened stainless steel

EAC Angle Protractor with Dial

Circular scale with needle pointer
Easy reading on main and auxiliary scales
Very low hysteresis
Precision movement with compensation for mechanical play.

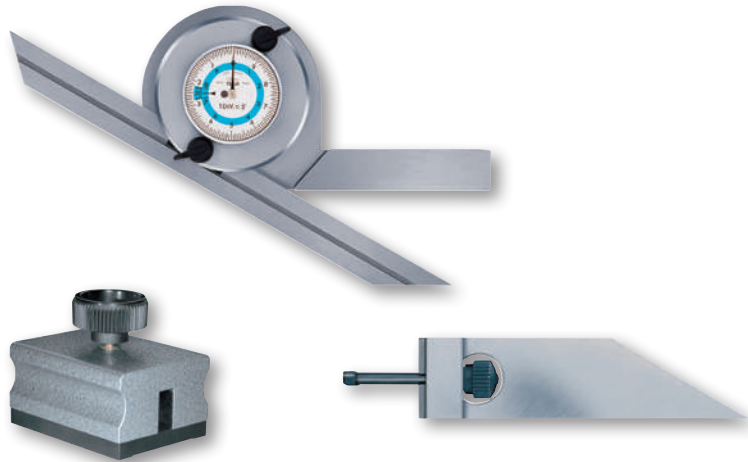

00610102

00610101

No	=		
00630001	EAC angle protractor with dial	4 x 90°	200
00630002	EAC angle protractor with dial	4 x 90°	300
OPTIONAL ACCESSORIES:			
00660002	Scale		200
00660003	Scale		300
00610102	Cast iron base with steel bottom surface, hardened		

- 5'
- Max. perm. error: 5' (without accessory)
- Stainless steel, hardened

ETALON Angle Protractor with Vernier Scale

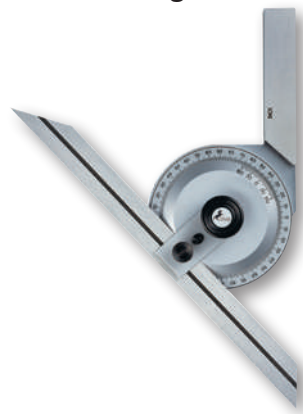

No	=			
076115566	ETALON angle protractor with vernier 200 mm	4 x 90°	No	200
076115567	ETALON angle protractor with vernier 300 mm	4 x 90°	No	300
OPTIONAL ACCESSORIES:				
00660002	Scale			200
00660003	Scale			300
00610102	Cast iron base with steel bottom surface, hardened			



Brown & Sharpe Angle Protractor - Multiple Combinations

This angle protractor combination set can be used as a scale, depth gauge, try square, centering tool, marker or even as a spirit level.

Hardened steel.
Measuring faces specially treated against scratches

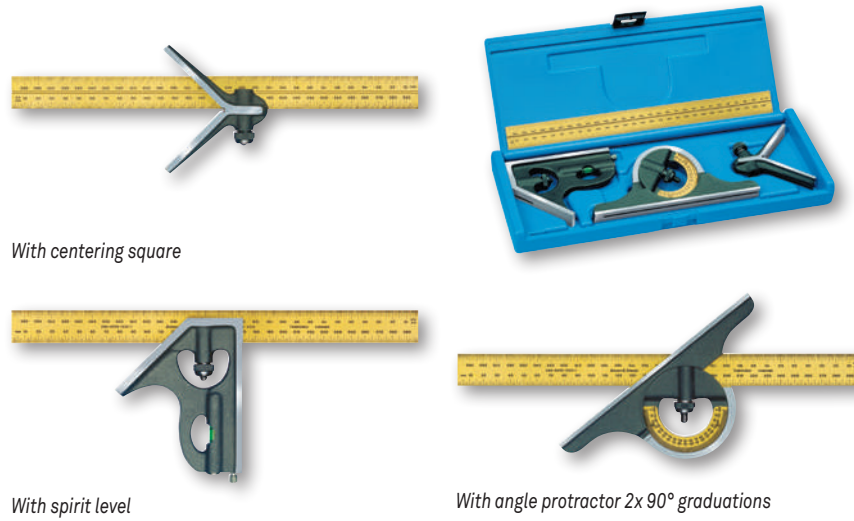

06719000	B&S angle protractor set with multiple combinations	Consisting of: - 1 Ruler graduated in millimetres, length 300 mm - 1 Angle protractor with 2 x 90° graduations - 1 Centering square - 1 Square head with scribe

Brown & Sharpe Sine Bar

Suited for setting ranges from 0 to 60°

Sine function for establishing the angle that needs to be set on the basis of the length dimensions obtained from parallel gauge blocks.

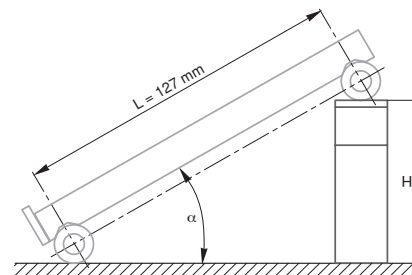
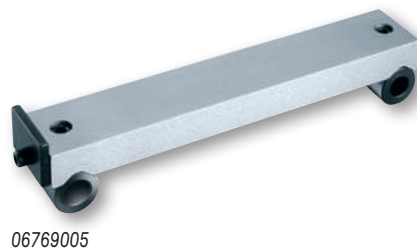

5 μ m
 Hardened alloy steel
 Removable front stop

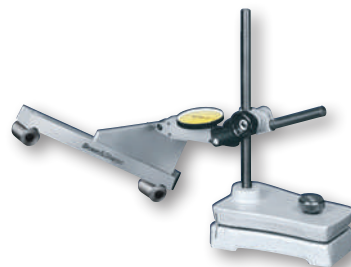

Example for the calculation of an angle
Given: H = height of combination gauge blocks in mm
L = length of B&S sine bar in mm

Formula: $H = L \cdot \sin(\alpha)$
 $\sin(\alpha) = H/L$
angle = arcsin (H/L)

Calculation for determining angle knowing H et L values:
angle = arcsin (89,803 / 127) = arcsin (0,70711) = 45°

06769005	B&S Sine bar	L (centre distance), mm	mm
		127 ± 0,004	123 x 25



Length and Angle Standards

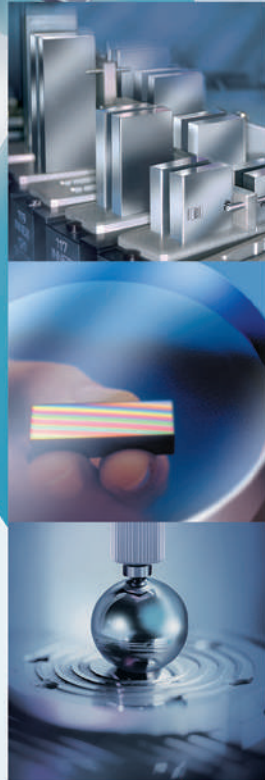
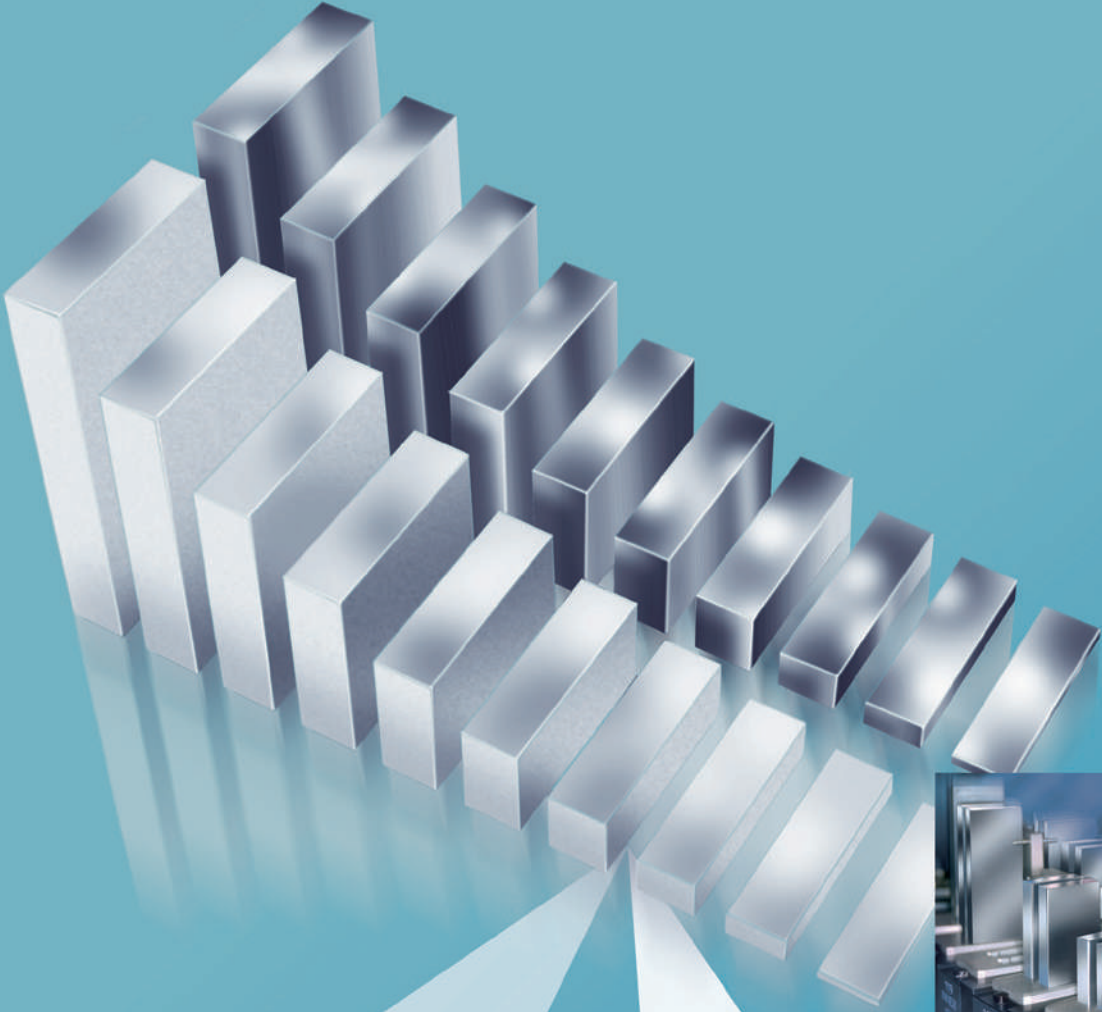

PURCHASING GAUGE BLOCKS CALLS FOR CONFIDENCE

The high accuracy of TESA's gauge blocks is the result of years of experience in producing and making use of these products.

- Use of high quality raw materials and appropriate heat treatment, thus guaranteeing a durable shape and dimensional stability of the gauge blocks over years.
- Very low deviations in flatness and parallelism of the measuring faces, resulting in highly accurate gauges.
- Unique flat lapping polish as well as edge rounding techniques, leading to superior wringability.
- Proper serial number marked on each gauge block.

ISO 3650

Gauge blocks with metric nominal lengths conform to ISO 3650:1998. This international standard is based on the ones published either in a region, e.g. the European standard EN ISO 3650:1998 or in a country, e.g. the Swiss standard SN EN ISO 3650, German standard DIN EN ISO 3650 or French standard NF EN ISO 3650. Gauge blocks with imperial nominal lengths comply with BS 4311 - Part 1. Compared to earlier standards, ISO 3650:1998 includes the following main changes :

- Withdrawal of the accuracy grade 00 (see "Which grade do you need").
- Introduction of requirements as regards the uncertainty of measurement in relation to the declaration of conformity of the product according to ISO 14253-1:1998.
- Review of some definitions and shortened form of terms according to normative references that are currently applicable (see drawing).

WHICH MATERIAL DO YOU NEED?

Steel

Steel gauge blocks have proven their reliability for more than a hundred years. This raw material remains the most commonly accepted for length standards.

Steel gauge blocks provide high resistance to wear associated with a good property to adhere to other gauge blocks. However, steel must be protected against corrosion. Provided gauge blocks made from this material are properly handled, they will remain reliable for many years. TESA steel gauge blocks have the following key features:

- Highly alloyed steel
- Hardness guaranteed to 800 HV
- Artificially aged for optimum form and dimensional stability
- Coefficient of thermal expansion: $(11,5 \pm 1,0) \times 10^{-6} K^{-1}$

Tungsten Carbide

Gauge blocks in tungsten carbide are 10 times as resistant to wear as steel gauges. They are intended for frequent use, also where superior wringing quality is required. TESA tungsten carbide gauge blocks provide:

- Hardness guaranteed to 1400 HV
- Coefficient of thermal expansion: $(4,23 \pm 0,1) \times 10^{-6} K^{-1}$

Ceramic

Ceramic gauge blocks are extremely resistant to wear and scratches. Due to the properties of this material, any minor damage is unlikely to affect the wringability of their measuring faces. Being corrosion resistant, these gauge blocks are insensitive to "rusty hands", amongst other issues. Manufactured from stabilised zirconia, TESA ceramic gauge blocks have the following key features:

- Non-magnetizable
- Hardness guaranteed to 1400 HV
- Coefficient of thermal expansion: $(9,7 \pm 0,8) \times 10^{-6} K^{-1}$



WHICH GRADE DO YOU NEED?

Grade 2

These gauge blocks are commonly used as **Working Standards** in inspection rooms within a manufacturing area to set and calibrate measuring instruments and other equipment as well as to inspect tools, fixtures and machines.

Grade 1

Gauge blocks of this class are mainly used as **Working Standards** to set and calibrate plug gauges and measuring instruments in measuring rooms or inspection areas within a manufacturing area.

Tolerance Grade 0

These gauge blocks are designated for use as **Company Standards** in calibration laboratories or environmentally controlled inspection rooms to set and calibrate plug gauges as well as measuring equipment.

Calibration grade K

Gauge blocks of this tolerance class are intended for use as **Reference Standards** in metrology oriented laboratories of National Institutes, precision measuring rooms and other laboratories of National Calibration Services, whether officially accredited or not.

They should be used as masters to calibrate gauge blocks, length standards of same accuracy and also measuring instruments.

Precision Grade 00

The new standard ISO 3650 no longer takes this accuracy grade into consideration as the uncertainties of measurement achieved with the procedure applied for calibration usually lead to a disparity against specified tolerances.

The rules to the expression of uncertainty of measurement for proving the conformity or nonconformity of the product with the specification, as stated in the standard ISO 14253- 1:1998, have dictated the decision to withdraw the accuracy grade 00.

A wide experience in practical use of gauge blocks has proven that gauges of the calibration class K could easily replace those of the earlier accuracy grade 00.

As a result, gauge blocks of grade 00 are no longer available.

CERTIFICATE OF CALIBRATION AND TRACEABILITY.

All set compositions from TESA are supplied with a certificate of calibration issued by the accredited calibration laboratory of a national calibration service.

This service can either be the Swiss calibration service (SCS), British calibration service (UKAS) or Deutsche Akkreditierungsstelle (DAkkS) depending on the manufacturer.

Accreditation is the authenticated assurance of the skills of the calibration laboratories as well as of the full traceability to national standards that conform with the International System of Units (SI).

This is for any reference standard or measuring equipment being used.

Owing to a multilateral agreement (MLA), any certificates of calibration issued by the members of the European Cooperation for Accreditation of Laboratories (EA) is internationally accepted.

DELIVERIES

TESA gauge blocks can be delivered individually or in full sets with nominal lengths as listed in this section. Additional gauge sets and lengths can be made available upon request. Since individual gauge blocks could no be listed in their whole here, any inquiry or purchase order should specify :

- Desired nominal length
- Chosen material
- Calibration grade or any other grade



Limit Deviations and Tolerances

	Limit deviations t_e			
	Tolerances t_v			
	Flatness tolerances t_f			
Nominal length	Calibration grades and other grades			
	K	0	1	2
	Flatness tolerance t_f			
mm	μm	μm	μm	μm
$0,5 = l_n \leq 150$	0,05	0,1	0,15	0,25
$150 < l_n \leq 500$	0,1	0,15	0,18	0,25
$500 < l_n \leq 1000$	0,15	0,18	0,2	0,25

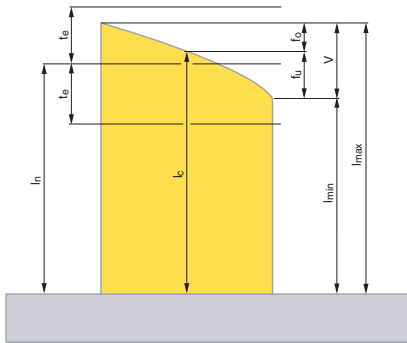

Nominal length l_n ; Central length l_c ; Variation v with f_0 and f_1 ; Limit deviations t_e at any point proceeding from the nominal length.

Nominal length	Calibration grade K		Grade 0		Grade 1		Grade 2	
	Limit deviation of length at any point from nominal length	Tolerance for the variation in length	Limit deviation of length at any point from nominal length	Tolerance for the variation in length	Limit deviation of length at any point from nominal length	Tolerance for the variation in length	Limit deviation of length at any point from nominal length	Tolerance for the variation in length

LIMIT DEVIATIONS AND TOLERANCES ACCORDING TO ISO 3650

mm	$\pm t_e$ μm	t_v μm	$\pm t_e$ μm	t_v μm	$\pm t_e$ μm	t_v μm	$\pm t_e$ μm	t_v μm
$0,5 = l_n \leq 10$	0,2	0,05	0,12	0,1	0,2	0,16	0,45	0,3
$10 < l_n \leq 25$	0,3	0,05	0,14	0,1	0,3	0,16	0,6	0,3
$25 < l_n \leq 50$	0,4	0,06	0,2	0,1	0,4	0,18	0,8	0,3
$50 < l_n \leq 75$	0,5	0,06	0,25	0,12	0,5	0,18	1,0	0,35
$75 < l_n \leq 100$	0,6	0,07	0,3	0,12	0,6	0,2	1,2	0,35
$100 < l_n \leq 150$	0,8	0,08	0,4	0,14	0,8	0,2	1,6	0,4
$150 < l_n \leq 200$	1,0	0,09	0,5	0,16	1,0	0,25	2,0	0,4
$200 < l_n \leq 250$	1,2	0,1	0,6	0,16	1,2	0,25	2,4	0,45
$250 < l_n \leq 300$	1,4	0,1	0,7	0,18	1,4	0,25	2,8	0,5
$300 < l_n \leq 400$	1,8	0,12	0,9	0,2	1,8	0,3	3,6	0,5
$400 < l_n \leq 500$	2,2	0,14	1,1	0,25	2,2	0,35	4,4	0,6
$500 < l_n \leq 600$	2,6	0,16	1,3	0,25	2,6	0,40	5,0	0,7
$600 < l_n \leq 700$	3,0	0,18	1,5	0,3	3,0	0,45	6,0	0,7
$700 < l_n \leq 850$	3,4	0,2	1,7	0,3	3,4	0,5	6,5	0,8
$800 < l_n \leq 900$	3,8	0,2	1,9	0,35	3,8	0,5	7,5	0,9
$900 < l_n \leq 1000$	4,2	0,25	2,0	0,4	4,2	0,6	8,0	1,0

LIMIT DEVIATIONS AND TOLERANCES ACCORDING TO BS 4311, PART 1:1993

in	$\pm t_e$ μin	t_v μin	$\pm t_e$ μin	t_v μin	$\pm t_e$ μin	t_v μin	$\pm t_e$ μin	t_v μin
$l_n \leq 0,4$	5	2	5	4	10	6	20	12
$0,4 < l_n \leq 1$	6	2	6	4	12	6	25	12
$1 < l_n \leq 1$	8	3	8	4	15	7	30	12
$2 < l_n \leq 3$	10	3	10	5	20	7	40	14
$3 < l_n \leq 4$	12	3	12	5	25	8	50	14

LIMIT DEVIATIONS AND TOLERANCES ACCORDING TO FACTORY STANDARD FOR GAUGE BLOCKS OVER 4 IN

in	$\pm t_e$ μin	t_v μin	$\pm t_e$ μin	t_v μin	$\pm t_e$ μin	t_v μin	$\pm t_e$ μin	t_v μin
$4 < l_n \leq 6$	31	3	15	5	31	8	63	16
$6 < l_n \leq 8$	40	3	20	6	40	10	79	16
$8 < l_n \leq 10$	47	4	23	6	47	10	95	18
$10 < l_n \leq 12$	55	4	28	7	55	10	110	20
$12 < l_n \leq 16$	70	5	35	8	70	12	140	20
$16 < l_n \leq 20$	87	5	43	10	87	14	174	24



GAUGE BLOCKS

Gauge Block Set M32, M47, M88, M112 and M122.

Nominal lengths 1 ÷ 100 mm in steel, carbide or ceramic.

Grades K, 0, 1 and 2 available in all sets. Steel gauges to all grades with DAkkS certificate. Carbide or ceramic gauges to all grades with UKAS certificate.

ISO 3650

Limit deviations t_s , see Table

Tolerances t_s , see Table

see Table

Steel: highly alloyed, wear resistant.
 Tungsten carbide: wear resistant and stable.
 Ceramic: stabilised zirconia, extremely resistant to wear and scratches

Steel: $(11,5 \pm 1,0) \times 10^{-8} K^{-1}$
 Tungsten carbide: $(4,23 \pm 0,1) \times 10^{-8} K^{-1}$
 Ceramic: $(9,7 \pm 0,8) \times 10^{-8} K^{-1}$

Steel gauges to all grades with DAkkS certificate. Carbide or ceramic gauges to all grades with UKAS certificate

TESA Gauge Block Set M32, Metric

No			Grade
0651516027	Steel	K	K
0651515027	Steel	0	0
0651511027	Steel	1	1
0651512028	Steel	2	2

Set compositions

mm	Steps, mm	Pieces
1,005	–	1
1,01 ÷ 1,09	0,01	9
1,1 ÷ 1,9	0,1	9
1,0 ÷ 9,0	1,0	9
10, 20, 30, 60	–	4

TESA Gauge Block Set M47, Metric

No			Grade
0651516021	Steel	K	K
0651515021	Steel	0	0
0651511021	Steel	1	1
0651512021	Steel	2	2

Set compositions

mm	Steps, mm	Pieces
1,005	–	1
1,01 ÷ 1,09	0,01	9
1,1 ÷ 1,9	0,1	9
1,0 ÷ 24,0	1,0	24
25 ÷ 100	25	4

TESA Gauge Block Set M88, Metric

No			Grade
0651516014	Steel	K	K
0651515014	Steel	0	0
0651511014	Steel	1	1
0651512014	Steel	2	2

Set compositions

mm	Steps, mm	Pieces
1,0005	–	1
1,001 ÷ 1,009	0,001	9
1,01 ÷ 1,49	0,01	49
0,5 ÷ 9,5	0,5	19
10 ÷ 100	10	10



TESA Gauge Block Set M112, Metric

No			Grade
0651516012	Steel	K	K
0651515012	Steel	0	0
0651511012	Steel	1	1
0651512012	Steel	2	2

Set compositions

mm	Steps, mm	Pieces
1,0005	–	1
1,001 ÷ 1,009	0,001	9
1,01 ÷ 1,49	0,01	49
0,5 ÷ 24,5	0,5	49
25 ÷ 100	25	4

TESA Gauge Block Set M122, Metric

No			Grade
0651516011	Steel	K	K
0651515011	Steel	0	0
0651511011	Steel	1	1
0651512011	Steel	2	2

Set compositions

mm	Steps, mm	Pieces
1,0005	–	1
1,001 ÷ 1,009	0,001	9
1,01 ÷ 1,49	0,01	49
1,6 ÷ 1,9	0,1	4
0,5 ÷ 24,5	0,5	49
30 ÷ 100	10	8
25,75	–	2



- ISO 3650
- Limit deviations t_e , see Table
- Tolerances t_v , see Table
- see Table
- Steel: highly alloyed, wear resistant.
Tungsten carbide: wear resistant and stable.
Ceramic: stabilised zirconia, extremely resistant to wear and scratches
- Steel: $(11,5 \pm 1,0) \times 10^{-6} \text{ K}^{-1}$
Tungsten carbide: $(4,23 \pm 0,1) \times 10^{-6} \text{ K}^{-1}$
Ceramic: $(9,7 \pm 0,8) \times 10^{-6} \text{ K}^{-1}$
- Steel gauges to all grades with DAkkS certificate.
Carbide or ceramic gauges to all grades with UKAS certificate



Special Versions

Available on request :

- Tungsten carbide gauge block set
- Ceramic gauge block set
- TESA maintenance kit

-  Diameter and thickness as shown in table
-  Optical flats with 2 flat measuring faces. No guaranty can be given for parallelism.

ACCESSORIES FOR GAUGE BLOCKS

The interference lenses allow visual inspection of the surface of the gauge blocks.

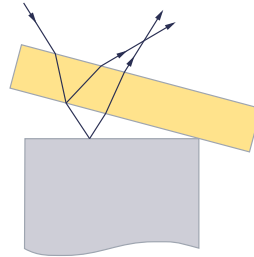

TESA Optical Flats

Used for examining flatness and adhesion of gauge blocks or any other test pieces having flat faces with same high grade of accuracy.

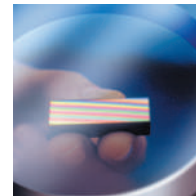

No	\varnothing		
	mm	Thickness, mm	μm
02530050	50	15	0,125
02530075	75	20	0,125



-  Light source: 35 W sodium lamp, 89% monochromatic, colour yellow, wavelength 0,575 μm
-  Surface plate: 0,5 μm
-  Surface plate: 2,5 μm
-  406 x 406 x 355 mm (W x D x H)
-  Surface plate in hardened steel
-  Case in lacquered wood

TESA Monochromatic Light Unit

For use with optical flats or optical parallels to measure both the flatness and parallelism of the measuring faces by interferometry.

Monochromatic light source providing high-contrast interference fringes.

This light unit uses a single wavelength so that bright/light fringes only are visible.

The light source at the rear of the case also permits a visual examination, e.g. with the aid of a knife-edge or bevelled straight edge.

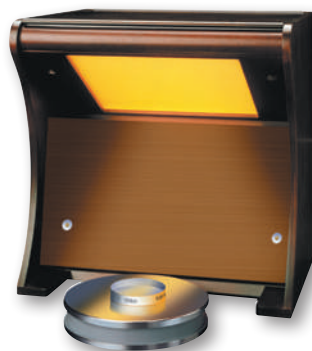

No	=	
		V
0652500422	Universal monochromatic light	210 ÷ 230
STANDARD ACCESSORIES:		
0651570269	200 mm dia. surface plate, lapped and polished measuring face	
0652500424	Sodium light bulb (spare lamp)	



Brown & Sharpe Angle Gauges

For setting and calibration purposes – Smallest step to 15' (1/4°).



30°



Width:
6,35 mm (1/4 in)
Length:
≥ 76,2 mm (3 in)



Hardened
steel



06769002



Precision angle block set



Set Composition

15' / 30' / 1° / 2° / 3° / 4° / 5° /
10° / 15° / 20° / 25° / 30°



Calibration Equipment



CONFIDENCE IS NOT ENOUGH...

The control of inspection and measuring equipment is an element of quality management that is now more important than ever before. The introduction of the ISO 9000 family of international standards has also led to major changes in this field. Amongst other things, ISO 9001 specifies that : "all inspection and measuring equipment that can affect product quality must be identified, calibrated and adjusted at prescribed intervals, or prior to use, against certified equipment having a known valid traceable relationship to internationally or nationally recognised standards".

This standard also states that the supplier shall: "ensure that the inspection and measuring equipment is capable of the necessary accuracy and precision".

A Vast Choice

TESA can offer you the most varied methods of measurement specifically suited for the inspection and calibration of standards, handtools and plug gauges. Some of these are described in the various sections of this catalogue, in particular:

- Gauge blocks
- Setting rings
- Cylindrical setting standards with outside diameters
- Optical flats
- Parallel optical flats
- Electronic levels for both straightness and flatness measurement
- Instruments for both squareness and perpendicularity measurement
- Calibration equipment for length measuring devices fitted with inductive probes.



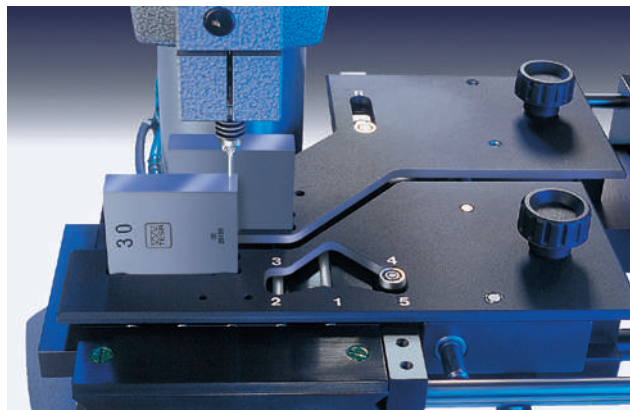
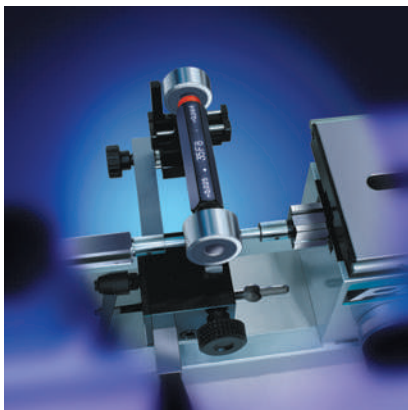



This section is devoted to measuring systems that serve to calibrate other inspection equipment, but they can also be used for high-accuracy measurement of precision parts.

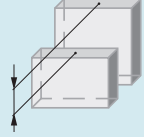

PRESENTATION OF TESA MEASURING GAGE BLOCKS

TESA offers two models, the operation of which is based on two different measurement procedures.

- TESA UPD directly measures gauge blocks within a measuring span of 25 mm/1 in.
- TESA UPC is used for comparative measurement of gauge blocks having a same nominal length.

TESA Gauge Block Comparators		UPD	UPC
 Measuring procedures <ul style="list-style-type: none"> - Comparison of different nominal lengths up to 25 mm - Number of reference gauge blocks required for the calibration of a set of 122 pieces: 9 blocks - Number of blocks required for the calibration of the device: 9 blocks + 6 pairs 		●	
		Comparative measurement <ul style="list-style-type: none"> - Comparison of gauge blocks having the same nominal length - Number of reference gauge blocks required for the calibration of a set of 122 pieces: 122 blocks - Number of gauge blocks required for the calibration of the device: 6 pairs 	●
 Measuring errors Read also the explanations provided in this same chapter with regard to the measuring errors of each instrument			
	Repeatability limit	0,015 µm 0,025 µm	●
Measuring uncertainty	U = ± (0,05 + 0,5 · L) µm L in m	●	●
	U = ± (0,10 + 1,0 · L) µm		●
 Range of application Nominal lengths	0,5 to 100 mm/0.02 to 4.0 in	●	●
	0,5 to 500 mm/0.02 to 20 in	▲	▲
 Measuring range 25 mm/1 in			●
 Sensors for capturing length dimensions <ul style="list-style-type: none"> - 2 axial probes in sum measurement - Digital measuring system, opto-electronic with incremental divisions - Analogue measuring system, electronic and inductive - Activation of the measuring force <ul style="list-style-type: none"> • electro-motorised • by spring force - Retraction of the measuring bolt <ul style="list-style-type: none"> • electro-motorised • by vacuum 		●	●
		●	
			●
		●	
			●
		●	
			●
		●	
			●
		●	
Template system <ul style="list-style-type: none"> - Single template system - Dual template system 		●	●
		●	○
Positioning of gauge blocks with a nominal length of up to 10 mm Suction loader with an electric vacuum pump		○	○
 TESA UPT temperature measuring device Measurement of the electrical resistance using 4 thermal sensors (4 wire type)		●	○
 TESA software for processing the measured values <ul style="list-style-type: none"> - TESA UP, WINDOWS 98, 2000, NT, XP, 7 (32 bits) 		●	●
▲ Available on request ○ Recommended option			



GAUGE BLOCK COMPARATORS

In the hierarchical chain of dimensional measurements that can be traced back to the standard metre length unit, gauge blocks hold a key position. This makes them the most important material references used in metrology.

The application of the length unit, based on specific wavelengths of light, to gauge blocks is achieved in the first instance by fundamental interferential measurement. Using gauge blocks measured by interferometry, defined lengths are thus transferred to other gauge blocks in measurements further down the hierarchical chain.

TESA UPD – for Direct and Comparative Measurements

- Direct measurement of gauge blocks with a variation in nominal length of up to 25 mm or 1 in.
 - Enables the number of reference gauge blocks required to be reduced by nearly 80 %.
- Comparative measurement of gauge blocks having a same nominal length.
 - Enables lower measurement uncertainties to be achieved due to weaker influences of the systematic errors.
- Equipped with HEIDENHAIN high-precision incremental probes.
- Templates with a new concept for positioning the gauge blocks.
 - Single or dual template system to provide optimum ease of handling of the gauge blocks
- Integrated device for most accurate temperature acquisition.
- On-line transfer of both measured length and temperature values.
- Computer-aided data processing with all the corrections necessary included.

Dual template system for the maintenance of your reference gauge blocks (TESA patented)

- The simultaneous use of two templates allows you to "rest up" your gauge blocks until you need them.
- The application of this new concept turns into significant savings in both time and money.
- During measurement cycles carried out on a routine basis, the distance travelled over the measuring table is reduced by nearly 70 %.
 - This contributes to significant reductions of the risks of damaging and wearing the measurement faces.
- The double protection of your reference gauge blocks leads to significant cost savings through the reduction if the need for:
 - recalibration
 - restoration of the measuring faces
 - replacement of worn or damaged gauge blocks
 - increased downtime (whilst extending the life of your reference gauge blocks)

Single Template System

- Using this system your reference gauge blocks are moved together with those to be calibrated during the measurement cycles.

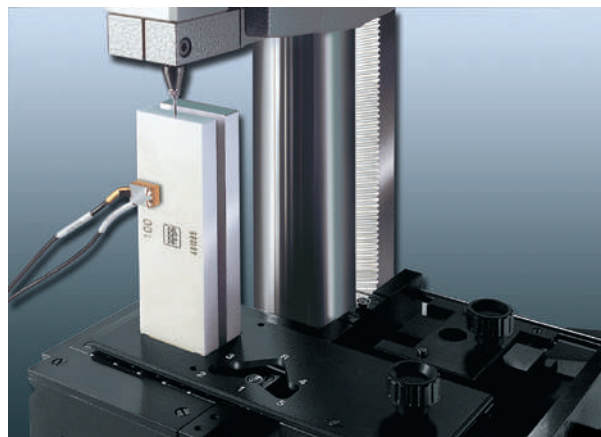
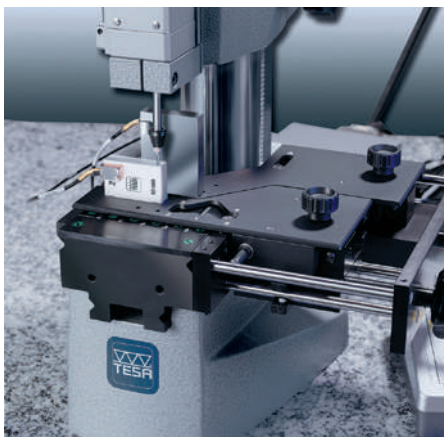

N EN ISO 3650 (ASME B89.1.9-2002 on request)

I For gauge blocks with nominal lengths from 0,5 mm to 100 mm / 0.02 in to 4 in (0,5 to 500 mm on request)

A **Measuring configuration**
Two probes with mechanical contact with the measuring face to be probed are connected in sum measurement (function +A+B).

Measuring points
On the reference gauge block: at the centre of the measuring face (point R).
On the gauge block to be measured: at the centre (point 1) as well as the four corners of the measuring face, each lying 2 mm away from the adjacent faces (points 2 to 5).

The central length l_c is determined by probing both points R and 1. For establishing lengths at any point, the measurements shall be carried out at points R plus 1 to 5.

The variation in length v is obtained from measurements taken at points 1 to 5.

C Calibration certificate from the supplier for the comparator or the Swiss Calibration Service for the temperature device.



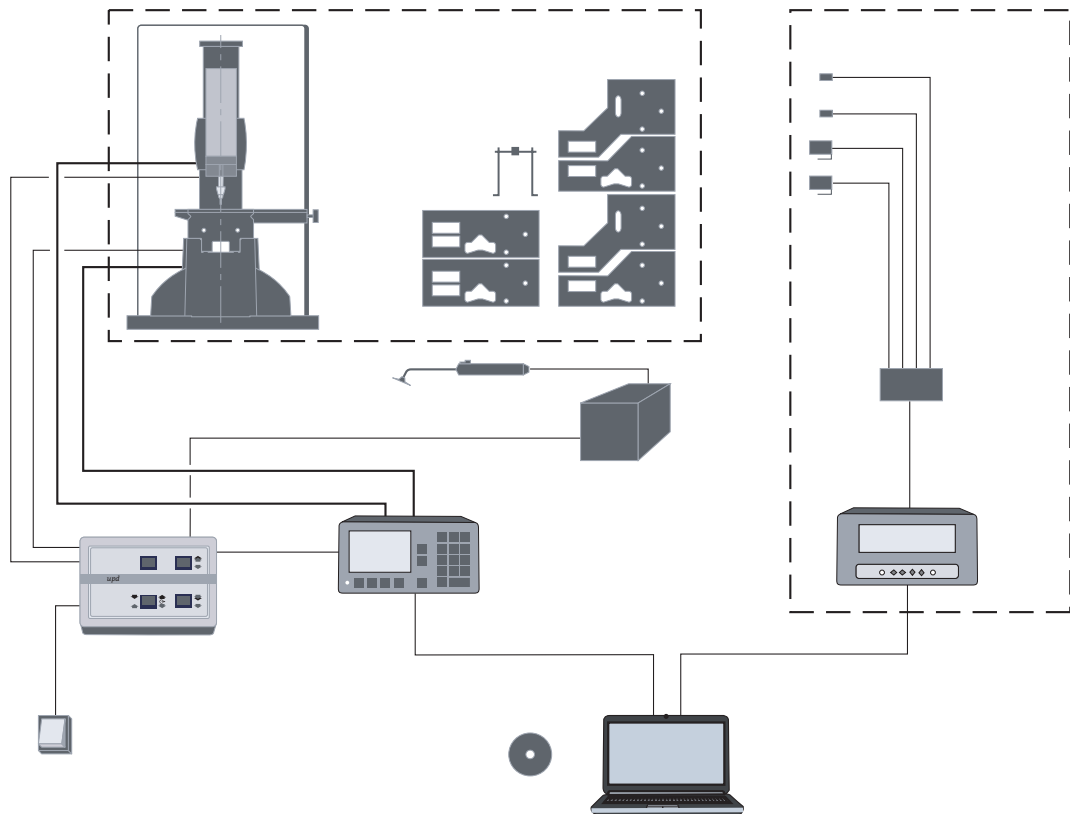

2 different delivery programs

No	=		
05930005	TESA UPD gauge block comparator with temperature device*		•
05930004	TESA UPD gauge block comparator without temperature device	•	
<i>CONSISTENT OF:</i>			
05930008	TESA UPD mechanical part	•	•
05960016	HEIDENHAIN computing counter ND 287 featuring 2 probe inputs	•	•
05960013	Control panel	•	•
05960014	Connecting cable for control panel to ND 287 computing counter	•	•
04768001	Foot switch	•	•
01660011	Suction loader		•
03260433	Electrical vacuum pump with external control, 230 VAC, 50 Hz		•
05960028	Connecting cable for electronic vacuum pump to control panel		•
05930011	TESA UPT temperature device, complete		•
Other delivery program available on request			
* Special execution for 110 VAC, 60 Hz also available on request (ref. S32070030 instead of 03260433)			

**Errors of Measurement**

Provided all metrological conditions are met, the reliability of the comparator used for direct measurement of steel gauge blocks is expressed as follows:

 Repeatability limit (with no influence of external temperature): 0,015 μm

 Uncertainty of measurement: $U = \pm (0,05 + 0,5 \cdot L) \mu\text{m}$ (L in m)

 Condition requires the use of reference standards whose measurement uncertainty is equal to:
 $U \leq \pm 0,015 \mu\text{m}$ for the comparator
 $U \leq \pm (0,02 + 0,2 \cdot L) \mu\text{m}$ (L in m) for the gauge blocks



TESA UPC – for Comparative Measurement

TESA UPC Gauge Block Comparator for Comparative Measurement

- Measures gauge blocks of same nominal length by comparison.
- Comes with the new template system for positioning the gauge blocks.
- Single or dual template system for optimum ease of gauge handling.
- Features TESA high-precision inductive probes.
- Allows ultra-precise temperature measurement, integrated.
- Transfers on-line all measured length and temperature values.
- Executes computer-aided data processing with all required correction values included.
- Performs calibrations that meet the requirements of both ISO standards and EA guidelines (EAL – European cooperation for Accreditation of Laboratories).
- Includes an execution for greater accuracy along with a calibration certificate (optional).





TESA UPC is specially designed for the calibration – or dimensional inspection – of gauge blocks with nominal lengths ranging from 0,5 to 100 mm. The configuration, which consists of two probes aligned opposite one another, associated with both the concept and quality of the measuring system provides full guarantee for an extra low uncertainty of measurement. Although TESA UPC is mainly intended for manufacturers and end-users of gauge blocks, this comparator is also widely used in nationally accredited laboratories.



If specified, TESA can also provide the temperature device available as an option. This device has 4 PT100 platinum resistances, each capturing the temperature of the two gauge blocks along with that of both the measuring table and the support. Computer-aided data processing lets you carry out any calibration most reliably and rationally – for sure.

 EN ISO 3650

 For gauge blocks ranging from 0,5 mm to 100 mm or 0.02 in to 4 in (0,5 to 500 mm on request)

 Comparative measurement procedure with transference of the length of a reference gauge block to the gauge block being measured.

Measuring configuration

2 probes connected in sum measurement (function +A+B) with mechanical contact with the measuring face.

Measuring points

On the reference gauge block: at the centre of the measuring face (point R). On the gauge block to be measured: at the centre (point 1) as well as the 4 corners of the measuring face, each lying 2 mm away from the adjacent faces (points 2 to 5).

Central length l_c is defined by probing both points R and 1.

Establishing lengths at any point requires measurements to be taken at points R plus 1 to 5.

Variation in length v is the result of measurements taken at points 1 to 5.

 ≈ 23 kg (comparator complete, but without computer). ≈ 4 kg (temperature device)

 All instruments with the option for greater accuracy are delivered with serial numbers

 In-house calibration certificate for the version with greater accuracy or declaration of conformity for the standard version. Temperature device with SCS certificate.



No				
TESA UPC GAUGE BLOCK COMPARATOR EQUIPPED WITH SINGLE TEMPLATE SYSTEM				
05930000	Standard execution without computer application			●
05930003	Execution for greater accuracy, with computer application		●	
TESA UPC GAUGE BLOCK COMPARATOR EQUIPPED WITH SINGLE AND DUAL TEMPLATE SYSTEM				
05930013	Execution for greater accuracy without computer application		●	
05930015	Execution for greater accuracy, with computer application	●		
EACH VERSION CONSISTS OF:				
01610401	TESA UPC mechanical part equipped with the single template system			● ●
05960030	TESA UPC mechanical part equipped with both single and dual template system	● ●		
03260401	Pneumatic retraction of the measuring bolt, manually operated			●
03260432	Electric vacuum pump with foot switch		●	
03260433	Electric vacuum pump with external control	●		●
01660011	Pneumatic suction loader	● ●	●	
04430012	TESATRONIC electronic unit TT90	● ●	● ●	
05960039	Set of TESA UPC accessories, including the components 04761049, 04760087 and 04761070			
04761049	Opto-RS cable, bidirectional	●		●
04760087	Opto-RS interface	●		●
04761070	Connecting cable TESATRONIC TT90 to vacuum pump	●		●
04768000	Hand switch	●		●
01690021	Option for greater accuracy with calibration certificate	● ●	●	

Error of Measurement

Provided all the metrological conditions are met, the reliability of the two standard executions No. 05930000 and 05930002 is expressed as follows:

Provided all the metrological conditions are met, the reliability of both executions No. 05930001 and 05930003 along with the option for greater accuracy (No. 01690021) is expressed as follows:

Repeatability limit (with no effect due to external temperature): 0,025 µm

Repeatability limit (with no effect due to external temperature): 0,015 µm

Measurement uncertainty*
 $U = \pm (0,10 + 1,0 \cdot L) \mu\text{m}$ (L in m)

Measurement uncertainty*
 $U = \pm (0,05 + 0,5 \cdot L) \mu\text{m}$ (L in m)

Condition involves the use of reference standards (see page L-14 and L-15) whose uncertainty is as follows:
 $U \leq \pm 0,030 \mu\text{m}$
 when calibrating the comparator
 $U \leq \pm (0,05 + 0,5 \cdot L) \mu\text{m}$ (L in m)
 when calibrating the gauge blocks

Condition involves the use of reference standards (see page L-14 and L-15) whose uncertainty is as follows:
 $U \leq \pm 0,015 \mu\text{m}$
 when calibrating the comparator
 $U \leq \pm (0,02 + 0,2 \cdot L) \mu\text{m}$ (L in m)
 when calibrating the gauge blocks

* Applicable to steel gauge blocks

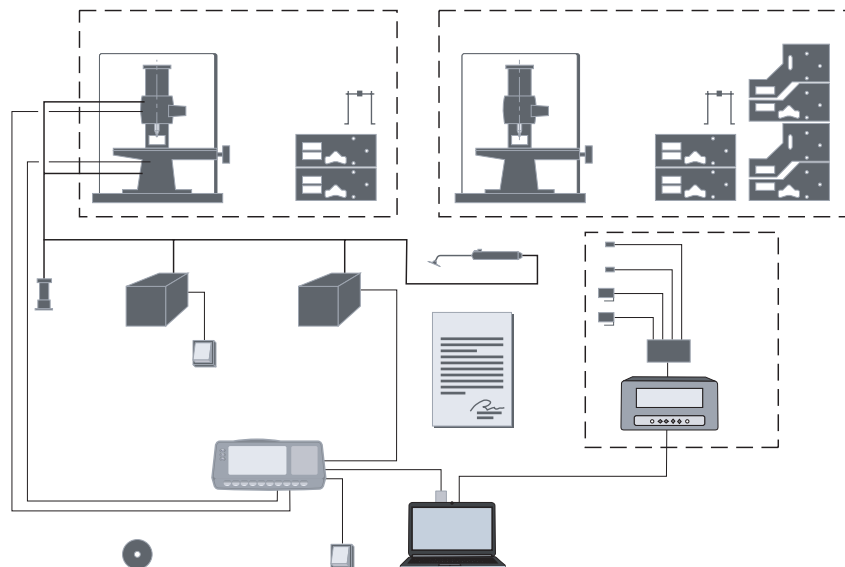

TESA UP – Software Programme for Value Processing

TESA UP programme for processing measured values suitable for both TESA gauge block comparators UPD and UPC as well as for comparators from other manufacturers.

- Choice of 10 languages.
- On-line processing of length and temperature values as transferred.
- Measurement cycles and result outputs according to EN ISO 3650.
- Flexible architecture for optimum adaptation to specific user's needs.
- Possible entry of limit values and accuracy grades peculiar to users.
- Surveillance of value dispersion or value drift throughout length and temperature measurements.
- Automatic execution of all relevant corrections. The programme makes allowances for actual sizes of the reference standards, flattening due to different materials used (steel, tungsten carbide, ceramic), compensation of temperature variations with reference to 20°C according to the varying coefficients of linear expansion – as typical examples.
- Assignment of gauge blocks to their relevant grade.
- Possible storage of gauge block set related data.
- Inch or metric value processing.
- Calibration certificate in several formats.

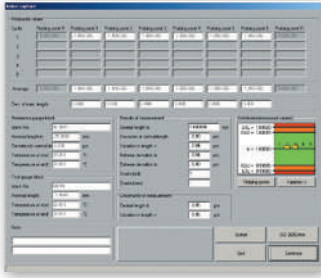

05960025	TESA UP software programme for gauge block calibration	1 CD-ROM plus 1 USB key of protection

Gauge Blocks for the Calibration of Comparators

To calibrate both TESA gauge block comparators UPD and UPC, we recommend the use of the gauge block set described hereafter. The 9-piece set is also required for calibrating TESA UPD.

Set composition including 11 steel gauge blocks, class K

Each pair is in full compliance with:

- EAL-G21 – Calibration of gauge block comparators – European cooperation for Accreditation of Laboratories
- DKD-R 4-1 – Guidelines of the German Calibration Service (DKD) for the calibration of gauge block comparators.

S59110152	Set of 11 gauge blocks with PTB (Physikalisch Technische Bundesanstalt) certificate	$\pm 0,015$
S59110489	Set of 11 gauge blocks with DAkkS certificate	$\pm 0,030$

Full tungsten carbide set also available on request

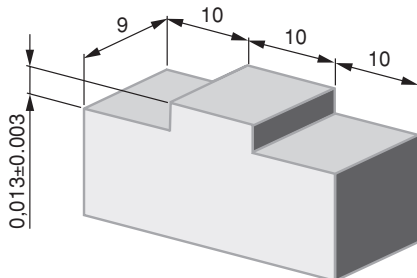

Pairs N°	Nominal length	
	A mm	B mm
1	0,5	0,5
2	1,0	1,005
3	1,0	1,01
4	4,5	4,5
5	100,0	100,0
6	6,0	6,0 *

* Special bridge-shaped gauge blocks (see drawing) used for establishing the measuring deviations of lower probe B.

- EN ISO 3650
- Minimum profile requirements for the computer needed to run the TESA UP software programme Personal Computer
 - Configuration without heat source to avoid disturbing the ambient temperature at the measurement spot
 - Operating system: Windows 7 or earlier versions (32 bits)
 - Processor: 650 MHz
 - 1 Hard disc (6 GB)
 - RAM capacity: 64 MB
 - CD-ROM drive (24x)
 - RS232 serial port
 - 1 for length values
 - 1 for temperature values
 - 3 USB ports

- EN ISO 3650
- Special high-alloy steel, wear resistant and stable. Exception: 6 mm special carbide gauge blocks.
- The given expanded uncertainty $k = 3$ refers to the difference of central length of both gauge blocks A and B forming the pairs 1 to 5 as well as to the deviations f_a and f_b from the central length of gauge blocks forming both pairs 2 and 3. No need to calibrate those of pair No. 6.



EN ISO 3650



Special high-alloy steel wear resistant and stable





For calibration certificates, see opposite

Expanded uncertainty $k = 2$ is valid for that given

Additional Gauge Block Set for Calibration of the TESA UPD System

In order to achieve the lowest uncertainty of measurement, we recommend the use of grade K gauge blocks which have been measured directly by interferometry and are supplied with a calibration certificate, irrespective of any other requirement such as the ambient conditions.

No	=	
S59300103	Set 9 gauge blocks with METAS certificate (Swiss)	$\pm 0,02 + 0,2 \cdot L \mu\text{m}$ (L in m)
S59300107	Set 9 gauge blocks with PTB certificate (Germany)	$\pm 0,02 + 0,2 \cdot L \mu\text{m}$ (L in m)
S59300104	Set 9 gauge blocks with SCS certificate	$\pm 0,05 + 0,5 \cdot L \mu\text{m}$ (L in m)

	Set composition (mm) 1 / 5 / 10 / 15 / 20 / 25 / 50 / 75 / 100
	Steel
	Accuracy grade K

Other set composition or carbide gauge blocks also available on request.

TESA UPT

Fully calibrated for the measuring ranges from 19°C up to 24°C with a numerical interval to 0,001°C.

Supplied with a calibration certificate issued by the Swiss Calibration Service (SCS). Uncertainty of measurement achieved during calibration $U = \pm 0,03^\circ\text{C}$.

No	=
05930011	Temperature measurement device
CONSISTING OF:	
05960018	Set of 4 temperature sensors PT 100
05960038	Measuring unit for temperature, FLUKE 1529
05960012	Interface Box 4 x PT 100
05960011	Connecting cable for adapter No. 05960012 to measuring unit No. 05960038
05960026	Connecting cable from UPC to computer (9-pin/m and 9-pin/f connector)



ETALON POLO HORIZONTAL MEASURING BENCH

A giant for small sizes – Specially designed for the control of measuring and test equipment in compliance with ISO 9000.

- Application range from 0 up to 100 mm for external dimensions of 2,5 up to 110 mm for internal dimensions – 50 mm measuring span.
- Resolution to 0,001 or 0,0001 mm – Metric/Inch conversion.
- Maximum permissible error of 0,5 μm .
- Measuring force from 0 to 4 N.
- Comes with a calibration certificate issued by the supplier.



Calibration of Standards:

- Cylindrical test pins
- Setting standards with cylindrical, plane-parallel measuring faces
- Threaded reference gauges (calibrated using the 3-wire method)
- Setting masters
- Setting rings

Workpiece Inspection:

External dimensions

- Stepped shafts
- Cutting tools
- Cylindrical pins
- Ball tips
- Grooves
- Short centring shoulders
- Threads (measured according to the 3-wires method)

Internal dimensions

- Through bores
- Blind bores
- Centring grooves
- Slots
- Sliding guides

Calibration of Plus Gauges:

- Limit plug gauges
- Plug gauges "GO"
- Plug gauges "NO GO"
- Plain plug gauges
- Ring gauges "GO"
- Ring gauges "NO GO"
- Threaded plug gauges

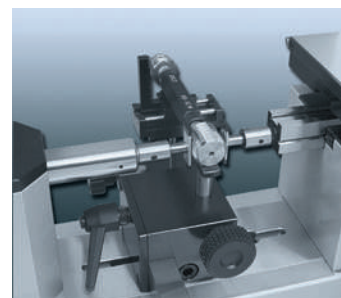
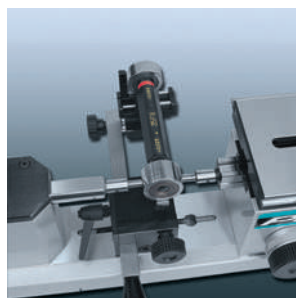
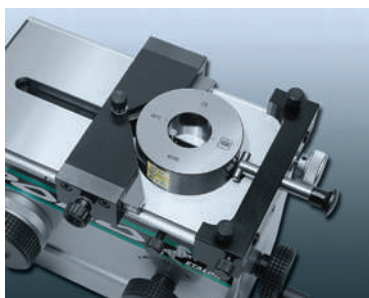

 Max. perm. error within the measuring span: 0,5 µm with standard accessories

 0,1 µm

 Opto-electronic measuring system with incremental glass scale, type LIF - HEIDENHAIN

 Tilting range of the floating table ± 0,5°

 EN 50081-1
EN 50082-2
EN 61000-4-2
EN 61000-4-4

 Setting 0 to 4 N

 50 mm measuring span

 19 kg net (main part alone, without table). Floating table: 2,8 kg net

 8,0 • 10⁻⁹/°C

 • 0 to 100 mm for external dimensions
• 10 to 110 mm with standard accessories
• 2,5 to 110 mm with optional accessories

ETALON POLO with Floating Resting Table

Calibration of measuring instruments

- Dial Gauges
- Lever Dial Test Indicators
- Electronic transducers



No

=

05939001 ETALON POLO measuring bench with floating table and electronic computing counter

CONSISTING OF:

05919002 Main part
05969024 1 pair of inserts for external dimensions
05969015 Floating measuring table
05969029 HEIDENHAIN computing counter ND 287

DELIVERED WITH THE FOLLOWING ACCESSORIES:

05969020 1 Pair of standard inserts for internal dimensions from 10 mm
05969030 Protective cover



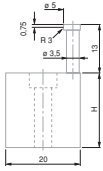

05969020

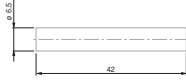

05969024

Pair of Standard Measuring Inserts for External and Internal Dimensions from 10 mm

No	=	A	Description
05969020			To be used with floating table N° 05960015, H = 20 mm
05969024			6,5mm Ø carbide inserts with a flat face

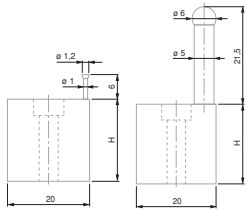

05969021

05969022

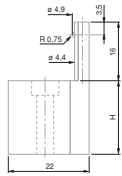

05969023

Measuring Inserts for Internal Measurement used with the Floating Resting Table

Height H = 20 mm. M4 locking screw.

No	=	A	Description
05969021			Internal measuring inserts from 2,5 mm
05969022			Internal measuring inserts from 13 mm
05969023			Internal measuring inserts from 5 mm



Bench Stand with Swivelling Plate

For raising the measuring bench from horizontal to vertical position. Accommodates a clamp lever. Length (upright): 295 mm, mass ≈ 20 kg.

No	=	A	Description
05969000			Bench stand with swivelling plate



Base for the Computing Counter

Base for raising up the HEIDENHAIN ND 287 counting unit, height 380 mm, weight 5,2 kg.

No	=	A	Description
05969001			Stand for computing counter

Floating Resting Table

Used for external measurement on oblong parts up to 60 mm in diameter; centres, L=160 mm; movable positioning fixture for parts having varying lengths, 3 freedom degrees.



No	=	A	Description
05969032			Resting table without vise
05969033			Vise for plug gauges
05969034			Floating table

Stands for Checking External Dimensions



No	=	A	Description
05969007			Ø 3 mm stand for external Ø
05969008			Ø 6 mm stand for external Ø

Stand with Ø 10 mm Fixing Bores

For H-shaped table (05969003) and for control system for lever-type indicator (05969004)



05969002 Stand with Ø 10 mm bore for 05969003 and 05969004

Centering Device

Allows the user to search for the transverse culmination point against the measuring direction. Used with either the fixed or floating table No. 05969014 or 05969015. Prismatic stop adjustable transversely, max. diameter 110 mm. Counter pressure piece finished with cylindrical stop pins.



05969012 Centering device for culmination point

Fixing Shank

For clamping the instruments that need to be calibrated such as dial gauges or precision indicators etc.



059690010



05969010 For fixing shafts with a Ø 8 mm

05969011 For fixing shafts with a Ø 3/8 in

Holder for a Dial Test Indicator (Lever-type)

Provided with 2 dovetail clamps, TESATAST-type or in compliance with BS 2795:1981



05969004 Holding device for test indicator

Spindle for Calibrating Dial Gauges, Dial Test Indicators and such like

Setting range = 50 mm, Spindle rotation = 0,5 mm



05969009 Spindle for calibrating dial gauges, dial test indicators and such like





Surface Roughness Testing



THE ROUGHNESS PARAMETERS MOST COMMONLY USED ARE: RA, RZ AND RMAX

TESA RUGOSOFT and MEASUREMENT STUDIO Software

These software tools allow the storage of surface roughness measurements along with roughness parameters and roughness profile. A measuring programme created in the software can be transferred to the instrument together with measuring parameters. The results are available at all times, complete with statistical analysis and can be exported for reports, for example.

Mean roughness Ra (ISO 4287, DIN 4768)

The mean roughness Ra matches the arithmetical mean of the absolute values related to the profile deviation y within the reference length l.

Max. profile valley depth Rmax (DIN 4768)

The max. profile valley depth Rmax is for the most significant single roughness depth Zi within the total length lm.

According to ISO 4288 and DIN 4287 - Part 1, this parameter is also specified as Ry max.

Mean roughness depth Rz DIN (DIN 4768)

The mean roughness depth Rz is the arithmetical mean of single roughness depths of successive sampling lengths le. According to ISO 4287 and DIN 4762, the parameter Rz DIN is also specified as Ry5.

Since Rz changes its name in both DIN 4768 and ISO 4287, this parameter is also specified as Rz DIN or Rz ISO. If the parameter Rz is measured according to DIN, it is generally admitted that the extreme value specified by ISO is matched providing that Rz ISO does not exceed Rz DIN.

Use of Roughness Comparison Specimens

These specimens are used for testing any surface finish quality and have long proven their value in practice.

They are used for touch and/or sight comparisons against the surface of work pieces that are produced using the same manufacturing process. The condition is that materials have to be comparable.

When comparing the workpiece surface against the specimen, roughness is not quantitatively expressed. The assessment of the extent to which the surface finish of both is alike can only be subjective.

Sight comparison requires optimum light source angle. For small surfaces, the use of a magnifying glass with up to 8x magnification is recommended.

Touch comparison is made using the finger tip or a small copper piece such as a coin, for instance.



RUGOSURF 20

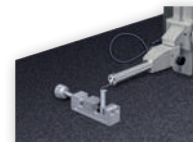

RUGOSURF 90G in profile measuring mode with PROFILE SET 2 mm

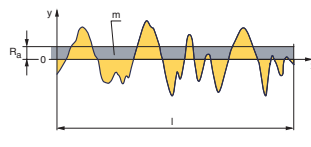
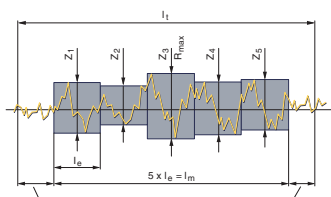

RUGOSURF 20 with dot matrix printer

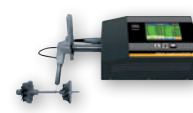

RUGOSURF 90G



RUGOSURF 20, RUGOSURF 10G, RUGOSURF 90G ROUGHNESS GAUGES

TESA offers a range of 3 portable RUGOSURF roughness gauges adapted for different levels of precision from the production floor to the test laboratory.

These devices are particularly appreciated by operators for their ease of use, robustness and reliability.

The range includes data management software to process measured values for an optimal overview of roughness profiles, statistical data and customizable measurement reports.



RUGOSURF 20



RUGOSURF 10G



RUGOSURF 90G



TESA RUGOSURF 20

Portable roughness gauge, robust and versatile.
Well suited for production environments or inspection of inward goods.

Measures roughness parameters according to:

- ISO 4287
- JIS B0601
- DIN and ISO 12085 (MOTIF or CNOMO).

Measuring range in the Z-axis of 400 μm (6300 μin).

15 roughness parameters.

Each parameter can be activated individually or not.

Possible tolerancing of parameter values.



Scope of supply

Direct display:

- of all measured values, with tolerance levels display,
- of R roughness profile,
- the Bearing Area Curve (BAC),
- the Amplitude Distribution Curve (ADC).



With a measuring stand with suction base

2" Black&White LCD screen, high contrast for optimum visual representation.

Flexible autonomy through mains adapter or battery pack.

Storage of the measured parameters.

Multilingual menu options.

USB cable connection (optional).

Direct printing to a dot matrix printer (optional).

Measurement transfer, database creation and reporting available using TESA RUGOSOFT software tool (optional).



Measurement of narrow hard to reach crevices thanks to the 100 mm probe extension

Access to narrow and hard to reach locations possible through 100 mm probe extension (optional).









With vertical positioning support

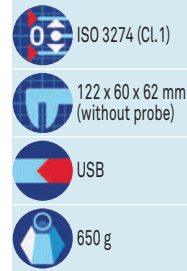

Description:

1. Start / Measure
2. Probe protection
3. LCD 2" screen
4. Enter key
5. Defilement key
6. Return key / Measurement parameters
7. ON/OFF Switch
8. Batter charger connector
9. USB Connector for PC
10. Printer connector



	06930013
	TESA RUGOSURF 20 portable surface roughness tester for use in the workshop Z = ± 200 µm (± 0.0079 in) X = 16 mm (0.63 in)
	Measuring span, µm 400 µm (0.0157 in) on Z axis, 16 mm (0.63 in) on X axis
	Indication span, µm Ra = 0 ÷ 100 µm; Rt = 0,05 ÷ 400 µm
	Accuracy class in accordance with ISO 3274 Class 1
	Measuring force, N 0,75 mN in accordance with ISO 3274
	Resolution, µm 0,001 µm
	Display LCD 2" black/white (160 x 100 pixels)
	Roughness parameters DIN / ISO / JIS / ASME: Ra, Rq, Rt, Rc, RSm, R _{Pc} R _{mr} , Rz, R _{max} PPc, P _{mr} MOTIF ISO 12085 (CNOMO): Pt, R, R _x , AR
	Graphics Bearing Area Curve (BAC), Amplitude Distribution Curve (ADC), Profile-R
	Cut-off length, mm 0,25 – 0,80 – 2,50 mm (0.010 – 0.030 – 0.100 in)
	Number of cut-off 1 to 5
	Stylus diamond tip (R = µm; angle °) R = 5 µm, 90°
	Memory capacity max 1000 measurements with parameters; max 20 measurements with profile and graphics
	Dimensions, mm 122 x 60 x 62 mm
	Degree of protection for keyboard (IP XX) IP67 (membrane keyboard)
	Digital data output (USB) USB cable connector to PC
	Weight, g 650 g
	Included in delivery RUGOSURF 20 SB10 standard skid probe Roughness standard Ra = 2,97 µm Positioning pin Ø 8 mm for use vertically Detachable probe protector Integral rechargeable battery Charger and adapter EU/US User manual Plastic carrying and storage case
	Measuring response time 1 to 10 s
	Probing speed, mm/s 1 mm/s (2 mm/s probe retract to measuring position)
	Units mm or inch
	Power supply 100 ÷ 240 VAC; 50 ÷ 60 Hz; 12 V, 400 ÷ 650 mAh



OPTIONAL ACCESSORIES:

04760099	Cable RUGOSURF 20 to PC
06960033	Printer for RUGOSURF + cables
06960034	RUGOSOFT Software + Dongle
06960035	Granite 400 x 250 mm with vertical support H150 mm, 25 kg, Grade 0 for Rugosurf 20 and 10G
06960081	Probe SB10 2µm for RUGOSURF 20 and 10G as SB10 but R = 2 µm
06960037	SB20 probe for RUGOSURF 20 et 10G for grooves of depth < 5 mm
06960038	SB30 probe for RUGOSURF 20 and 10G for small bores of Ø > 4 mm
06960039	SB40 Probe for RUGOSURF 20 and 10G V-shape for cylinders of Ø > 1 mm
06960040	SB50 probe for RUGOSURF 20 and 10G for concave surfaces and for measuring at 90° with RUGOSURF 10G
06960057	SB110 probe for RUGOSURF 20 and 10G for concave or convex surfaces, R > 5 mm
06960056	100 mm extension for probe with skid for RUGOSURF 20, 10G, 90G
06960064	Roughness standard Ra = 0,1 µm (4 µin)
06960065	Roughness standard Ra = 0,5 µm (20 µin)
06960066	Roughness standard Ra = 1,0 µm (40 µin)

STANDARD ACCESSORIES:

06960036	SB10 standard probe for RUGOSURF 20 and 10G R = 5 µm, 90°
06960041	Roughness standard Ra = 2,97 µm (117 µin)
06960045	Battery NiMH 7,2 V, 300 mAh, format PP3 for RUGOSURF 20 et 10G
057655	Vertical and adjustable positioning supports (2 parts) V-form for cylinder Ø > 100 mm for RUGOSURF 20
057941	Transport case with internal protection foam for RUGOSURF 20



- ISO 3274 (Cl.1)
- 122 x 53 x 75 mm (without probe)
- USB
- 590 g

TESA RUGOSURF 10G

Portable, versatile gauge unit with compact design, well suited for use in goods inwards inspection, production or the measurement laboratory.

3 horizontal measuring positions of probe 0°, -90° et +90°.

Measures roughness parameters according to standards:

- ISO 4287
- JIS B0601
- DIN and ISO 12085 (MOTIF or CNOMO).

TFT 2" graphic display for optimum visual representation of any measured parameters and workpiece profiles.

Direct displaying of all measured values and computed profiles.

31 roughness parameters available.

Flexible autonomy through mains adapter or battery pack.

Data storage, printing or transfer to a PC of a maximum of 999 measured results.

Possible tolerancing of all parameter values.

Multilingual menu options.

USB data output enabling a direct connection to a matrix printer unit or a PC equipped with RUGOSOFT 10 software (both are optional).

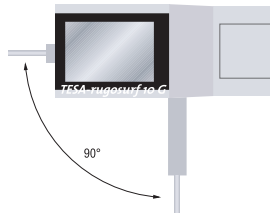

Probe measuring positions at -90°, 0°, +90°

Ra	0,088 μm
Rq	0,116 μm
Rt	0,889 μm
Rp	0,264 μm
05:09	Parameters

Measuring results

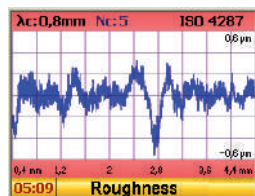

Profile measurement

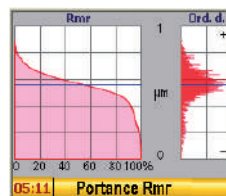

Bearing area curve (BAC) and amplitude distribution curve (ADC)



Measuring travel



	06930011
	TESA RUGOSURF 10G portable surface roughness tester for use in the workshop Z = ± 200 µm (± 0.0079 in) X = 16 mm (0.63 in) 3 probe measuring positions
	Measuring span, µm 400 µm (6300 µin) on Z axis, 16 mm (0.63 in) on X axis
	Display span, µm Ra = 0 ÷ 100 µm; Rt = 0,05 ÷ 400 µm
	Precision class in accordance with ISO 3274 Class 1
	Measuring force, N 0,75 mN (in accordance with ISO 3274)
	Resolution, µm 0,001 µm (0.1 µin)
	Display TFT 2" colour graphic screen
	Roughness parameters DIN / ISO / JIS / ASME: Ra, Rq, Rt, Rp, Rc, Rv, RSm, Rδc, RPc Pa, Pq, Pt, Pp, Pc, Pv, PSm, Pδc, PPc Rmr, Rz, Rmax Rk, Rpk, Rvk, Mr1, Mr2 DB N 31007: R3z, R3zm MOTIF ISO 12085 (CNOMO): Pt, R, Rx, AR
	Graphics Bearing area curve, profil-R, profil-P
	Cut-off length, mm 0,25 – 0,80 – 2,50 mm (0.01 – 0.03 – 0.10 inch)
	Number of cut-off 1 to 10 for a cut-off of 0,25 and 0,8 mm
	Diamond point of stylus (R = µm; angle °) R = 5 µm, 90°
	Built-in memory Max. 1000 parameters; max. 20 measurements with parameters, profiles and graphics
	Dimensions, mm 122 x 53 x 81 mm
	Degree of protection of keyboard (IP XX) IP67
	Digital output (USB) USB cable connector to PC
	Weight, g 590 g
	Included in delivery RUGOSURF 10G Roughness standard Ra = 2,97 µm Built in rechargeable battery SB10 standard probe Battery charger EU and US Adaptor Positionng clamp for stand Ø 8 mm Vertical positoning stand User instructions
	Probing speed, mm/s 1 mm/s
	Units mm or inch
	Power supply 100 ÷ 240 VAC; 50 ÷ 60 Hz, 12 V, 400 ÷ 650 mA



OPTIONAL ACCESSORIES:

06960062	Cable RUGOSURF 10G and RUGOSURF 90G to PC (connector v3)
06960033	Printer for RUGOSURF + cables
06960034	RUGOSOFT Software + Dongle
06960035	Granite 400x250 mm with vertical support H 150 mm, 25 kg, Grade 0 for Rugosurf 20 and 10G
06960081	Probe SB10 2 μ m for RUGOSURF 20 and 10G as SB10 but R = 2 μ m
06960037	SB20 probe for RUGOSURF 20 et 10G for grooves of depth < 5 mm
06960038	SB30 probe for RUGOSURF 20 and 10G for small bores of $\varnothing > 4$ mm
06960039	SB40 Probe for RUGOSURF 20 and 10G V-shape for cylinders of $\varnothing > 1$ mm
06960040	SB50 probe for RUGOSURF 20 and 10G for concave surfaces and for measuring at 90° with RUGOSURF 10G
06960057	SB110 probe for RUGOSURF 20 and 10G for concave or convex surfaces, R > 5 mm
06960056	100 mm extension for probe with skid for RUGOSURF 20, 10G, 90G
06960064	Roughness standard Ra = 0,1 μ m (4 μ in)
06960065	Roughness standard Ra = 0,5 μ m (20 μ in)
06960066	Roughness standard Ra = 1,0 μ m (40 μ in)

STANDARD ACCESSORIES:

06960036	SB10 standard probe for RUGOSURF 20 and 10G R = 5 μ m, 90°
06960041	Roughness standard Ra = 2,97 μ m (117 μ in)
06960045	Battery NiMH 7,2 V, 300 mAh, format PP3 for RUGOSURF 20 et 10G
056631	Adjustable vertical positioning supports (2 parts) V-form for cylinder $\varnothing > 100$ mm for RUGOSURF 10G
06960047	Transport case with internal protection foam for RUGOSURF10-10G





Probe measuring position at 90° and adjustable in height

TESA RUGOSURF 90G

Small-size, versatile roughness gauge with tactile colour screen providing maximum ease of use. Ideally suited for high-precision measurements on the shop floor or in the inspection laboratory.

Special features of RUGOSURF 90G:

- Supplied with SB60/10 probe with removable pad: one single probe can be used to measure roughness or undulation!
- RUGOSURF 90G can measure a components with a height of up to 90mm, thanks to a vertical positioning screw without any additional accessory!
- With the PROFILE SET 2 mm (06960100) RUGOSURF 90G becomes a profile measurement instrument with a width of 2000 µm measuring in the Z axis (optional)!

Tactile TFT 3.5" colour screen.

Direct display of all measured values and computed profiles.

Measuring span

$$Z = 1000 \mu\text{m} (0.039 \text{ in})$$

$$X = \text{up to } 50 \text{ mm}$$



RUGOSURF 90G with tactile colour screen
Measurement with or without skid

Special 2 in 1 probe can measure with contact skid (roughness measurement) or without contact skid (measure of undulation).

Vertical adjusting screw for probe positioning up to a height of 90 mm without the need of an accessory.

Tolerancing of all parameters possible.

USB digital output for transfer of measured values to a PC with TESA MEASUREMENT STUDIO software (optional).

Unique in its category, this instrument can also do profile measurement (Z = 2 mm) if used with PROFILE SET 2 mm (optional).

Measures roughness parameters according to standards:

- ISO 4287
- 12085 (CNOMO)
- ISO 13565
- DIN 4776
- JIS B0601:2001
- ASME B46-2002

- ISO 3274 (cl. 1)
- 270 x 140 x 90 mm (without probe)
- USB
- 3 kg

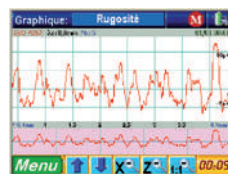

Roughness profile



Roughness parameters

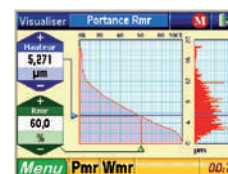

Bearing area curve (BAC) and amplitude distribution curve (ADC)

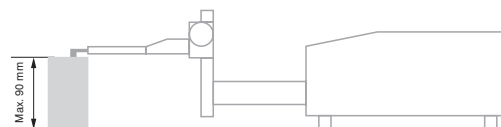

Fine adjustment of vertical position up to 90 mm

	06930012	
		TESA RUGOSURF 90G portable table roughness tester Z = ± 500 µm (± 0.0197 in) X = 50 mm (1.968 in) probe with detachable skid
	Measuring span, µm	Z Axis = 1000 µm (39370 µin); X Axis = 50 mm (1.969 in)
	Indication span, µm	Ra = 0 ÷ 400 µm; Rt = 0 ÷ 1000 µm
	Precision class	In accordance with ISO 3274 Class 1
	Measuring force, N	0,75 mN according to ISO 3274
	Resolution, µm	0,001 µm (0.01 µin)
	Display	Tactile graphic colour screen TFT 3.5" (320 x 240 pixels)
	Roughness parameters	DIN / ISO / JIS / ASME: Ra, Rq, Rt, Rp, Rc, Rv, RSm, Rδc, RPc Pa, Pq, Pt, Pp, Pc, Pv, PSm, Pδc, PPc Wa, Wq, Wt, Wp, Wc, Wv, WSm, Wδc, WPC Rmr, Rz, Rmax, Rsk, Rku, Wz Rk, Rpk, Rvk, Mr1, Mr2 DB N 31007: R3z, R3zm MOTIF ISO 12085 (CNOMO): Pt, R, Rx, AR, Wte, W, AW, Wx, Rke, Rpke, Rvke, Pdc, PPc, Mr1e, Mr2e
	Graphics	Profil-W, Profil-R, Profil-P, Bearing area curve
	Cut-off length, mm	0,08 – 0,25 – 0,80 – 2,50 – 8,00 mm
	Number of cut-off	1 to 19 for cut off up to 2,5 mm; 1 to 5 for cut off of 8,00 mm
	Diamond or stylus tip (R = µm; angle °)	R = 5 µm, 90°
	Memory capacity	Max. 60'000 measurements with parameters
	Dimensions (mm)	270 x 140 x 90 mm
	Degree of protection of keyboard (IP XX)	IP67 (membrane keyboard)
	Digital output (USB)	USB cable connector to PC
	Weight, kg	3 kg
	Included in delivery	<ul style="list-style-type: none"> – RUGOSURF 90G – Roughness standard Ra = 2,97 µm – Standard probe SB60/10 with or without skid – Probe holder – Guiding column, vertical setting range 90 mm – Integrated rechargeable battery, 12 V – Charger for battery
	Measuring response time	–
	Probing speed, mm/s	0,5 mm/s or 1,0 mm/s selection options
	Units	mm or inch
	Power supply	100 ÷ 240 VAC / 50 ÷ 60 Hz; 18 V, 2,2 Ah



OPTIONAL ACCESSORIES:

06960062	Cable RUGOSURF 10G and RUGOSURF 90G to PC (connector v3)
06960033	Printer for RUGOSURF + cables
06960048	MEASUREMENT STUDIO software + dongle for RUGOSURF 90G
06960055	Granite 630 x 400 mm with vertical support H250mm, 60 kg, Grade 0 for RUGOSURF 90G
06960064	Roughness standard Ra = 0,1 µm (4 µin)
06960065	Roughness standard Ra = 0,5 µm (20 µin)
06960066	Roughness standard Ra = 1,0 µm (40 µin)
06960100	PROFILE SET 2 mm for profile measurement with RUGOSURF 90G
06960056	100 mm extension for probe with skid for RUGOSURF 20, 10G, 90G
06960067	SB60/10 2µm probe for RUGOSURF 90G as SB60/10 but R = 2 µm
06960050	SB20P probe for RUGOSURF 90G for grooves of depth < 5 mm
06960051	SB30P probe for RUGOSURF 90G for small bores with Ø > 4 mm
06960052	SB40P probe for RUGOSURF 90G V-shape for cylinders with Ø > 1 mm
06960053	SB50P probe for RUGOSURF 90G for concave surfaces and for measuring at 90° with RUGOSURF 90G
06960054	SB120P probe for RUGOSURF 90G for grooves of depth < 20 mm
06960058	SB120S probe without skid for RUGOSURF 90G for grooves of depth < 15 mm
06960061	SB60-D2-L30 probe, L = 30 mm for RUGOSURF 90G for small bores of Ø > 2 mm

STANDARD ACCESSORIES:

06960049	SB60/10 standard probe for RUGOSURF 90G R = 5 µm, 90° detachable skid
06960041	Roughness standard Ra = 2,97 µm (117 µin)
056645	Transport case with internal protective foam for RUGOSURF 90G



N Roughness parameters according to: ISO 4287, ISO 13565-1, ISO 13565-2, ISO 12085, VDA 2007

Z = 2 mm
X = 50 mm

Z = 0,1 μ m
X = 0,4 to 4,0 μ m according to the length being measured

Z = 3,5 + 0,75*H microns, (H in the Z axis, in mm)
X = 3,5 + L/10 microns (L in the X axis, in mm)

0,3 mg (0,003 mN) with the SB2000 probe

1 mm/s

Maximum angle of 70° (upward position); maximum angle of 85° (downward position)

TESA PROFILE SET 2 mm

PROFILE SET 2 mm for profile measurement (compatible with RUGOSURF 90G).

When equipped with the SB2000 probe and used with the PROFILE STUDIO software dedicated for profile measurement STUDIO PROFILE, the RUGOSURF 90G roughness gauge converts into a profile-measuring tool.

A simple, ingenious and accurate solution, this optional accessory measures lengths, radii and angles of parts which are sometimes impossible to verify by other means.

The setting up and the evaluation of measurements is simple and fast. Dimensions can be inserted into the measured profile after defining geometric elements (point, line, arc or intersection between two lines, for example). The tolerance values allow verification of the results at a glance. Rotation and symmetry of the profile also allows its orientation.

A previous measurement can be used as model for the repeated measurement of a part of identical geometry. This saves valuable time and facilitates operations as important manual measurements can be replicated automatically.

A standard profile with a measurement report is included in the PROFILE SET 2 mm set.

A detailed measurement report with customizable header can be generated from the PROFILE STUDIO software.

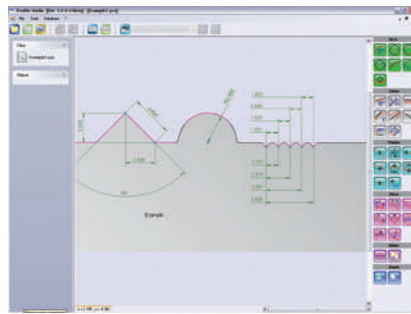

PROFILE STUDIO software

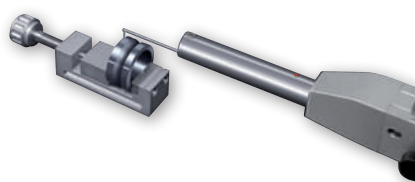
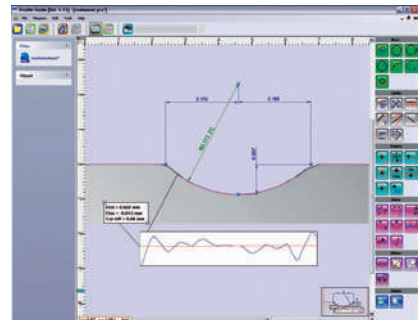

SB2000 probe

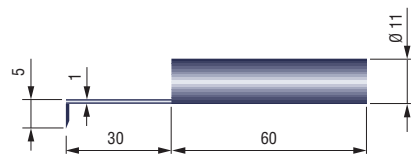

Nº

=

06960100 PROFILE SET 2 mm for profile measurement with RUGOSURF 90G

DELIVERED WITH THE FOLLOWING ACCESSORIES:

06960101 PROFILE STUDIO Software

06960102 SB2000 probe for PROFILE SET 2 mm, R = 15 μ m, 20°

06960103 Setting master for PROFILE SET 2 mm

06960062 Cable RUGOSURF 10G and RUGOSURF 90G to PC (connector v3)



RUGOSOFT Software

Software for RUGOSURF 20 and RUGOSURF 10G.

Enables the user to import stored measurement values from the device to the computer for the management of a database.

Optimal and detailed visualization of the results: parameters, profiles (R roughness and P primary profile) or a combination of both.

Calculation of roughness parameters.

Statistical analysis of a set of measurements.

Creation and storage of measuring programs (instrument parameters and parameters to be measured) in the software, which can then be loaded onto the instrument.

Customizable measurement report.

Output from the PC

- measuring results with measuring parameters
- profiles as coordinates
- measuring report in format: .xls .pdf .doc .rpt (Crystal Report) or also .rtf (Rich Text Format)

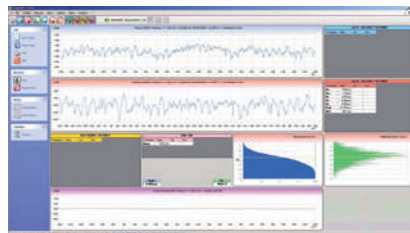

RUGOSOFT

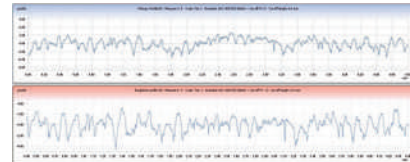

Roughness profile and primary profile

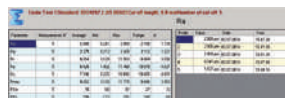

Statistics



Parameters and bearing area curve

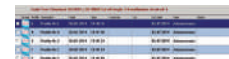

List of measurements



Included in delivery

06960034	RUGOSOFT Software + Dongle	<ul style="list-style-type: none"> - USB protection key (dongle) - Installation CD - User instructions plus online support (included in the installation CD)
-----------------	----------------------------	---

OPTIONAL ACCESSORIES:

04760099	Cable RUGOSURF 20 to PC
06960062	Cable RUGOSURF 10G and RUGOSURF 90G to PC (connector v3)



MEASUREMENT STUDIO Software

Software for RUGOSURF 90G.

Enables the import of stored measurement data from the device to the computer, for processing in a database.

Optimal and detailed visualization of the results: parameters, profiles (W undulation, P primary profile and R roughness) or the three.

Calculation of roughness parameters including VDA parameters.

Statistical analysis of a set of measurements.

Creation and storage of measuring programs in the software, which can then be loaded onto the instrument.

Customizable measurement report.

Output from the computer

- measuring results with measuring parameters
- profiles as coordinates
- measuring report in format .xls .pdf .doc .rpt (Crystal Report) or .rft (Rich Text Format)



MEASUREMENT STUDIO

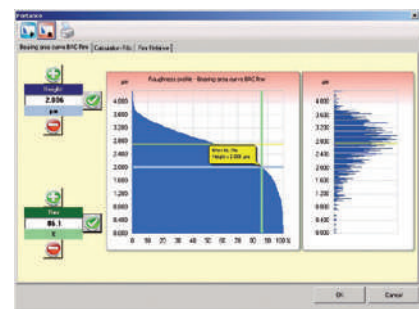

Bearing area curve

Parameter	Measurements	Average	Min	Max	Range	St
Pa	3	2.421	0.828	4.214	3.386	0.982
Pb	3	2.841	0.942	4.741	3.799	1.268
Pc	3	5.995	4.294	11.954	7.660	4.329
Pd	3	2.989	1.137	4.126	2.989	1.292
Pe	3	6.186	2.288	8.881	6.593	2.022
Pf	3	8.187	3.467	11.917	7.966	3.252
Pg	3	6.621	1.263	10.278	9.015	3.868
Ph	3	0	0	0	0	0
Pi	3	6.986	4.294	11.954	7.660	3.327
Pj	3	0	0	0	0	0
Pk	3	2.179	0.626	3.216	2.591	1.100
Pl	3	2.483	0.679	3.622	2.943	1.200
Pm	3	5.957	4.489	10.262	5.773	2.629
Pn	3	2.985	1.756	4.214	2.458	1.471
Po	3	6.192	2.750	7.225	4.445	2.172
Pp	3	7.625	1.737	10.266	8.529	3.734
Pq	3	0	0	0	0	0
Pr	3	0.957	0.455	1.022	0.567	0.309
Pt	3	0	0	0	0	0
Ps	1	0.336	0.336	0.336	0.366	0.000
Pu	1	0.695	0.695	0.695	0.966	0.000
Pv	1	0.912	0.912	0.912	0.966	0.000
Pw	1	0.906	0.906	0.906	0.966	0.000
Px	1	0.906	0.906	0.906	0.966	0.000
Pz	1	0.906	0.906	0.906	0.966	0.000
Paa	0	10.201	4.216	12.829	8.613	2.760
Pab	3	7.262	2.427	10.452	8.025	2.547
Pac	3	7.881	2.794	11.200	8.406	3.072
Pada	0	0.000	0.000	0.000	0.000	0.000
Padb	0	0.000	0.000	0.000	0.000	0.000
Padc	0	0.000	0.000	0.000	0.000	0.000
Pdad	0	0.000	0.000	0.000	0.000	0.000

Statistics

Paw VDA 2007			
Parameter	Value	Tol-	Tol+
wD5m	0.273 µm		
wDc	0.571 µm		
wDt	2.243 µm		

VDA parameters

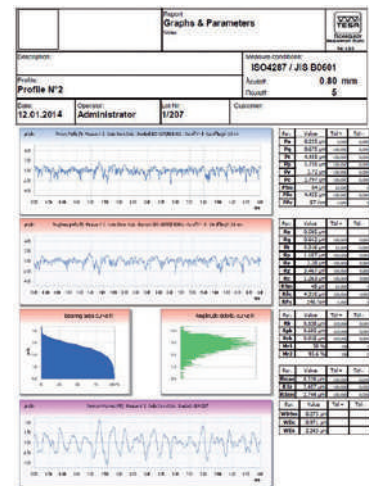

Measuring report with customisable header and logo



06960048

MEASUREMENT STUDIO software + dongle for RUGOSURF 90G

Included in delivery

- USB protection key (dongle)
- Installation CD, 6 languages
- User instructions (included on the installation CD)
- USB connection cable to the PC for RUGOSURF 10G and RUGOSURF 90G, length 1,80 m



PROFILE STUDIO Software

For profile measurement using the RUGOSURF 90G.

Allows evaluation of micro and macro geometric characteristics of a surface.

Measurement programme creation that can be saved for the same measurements on a batch of identical parts from the same set or for subsequent batch measurements: it is possible to use all the dimensions and tolerances of a reference profile for a measurement of a batch of the same part.

Measurement instructions and help assistance for calibration controlled from the PC.

Import and export of measurement parameters from and to the device.

Storage of measurement results and of the measured parameters as database.

Database search with filters (date, operator, batch, etc.).

Detailed visualization of the measured profile and geometric construction tools (arc, line, point, intersection, angle, etc.).

Measurements reports with customizable header.

Languages: English, German, French, Spanish, Italian, Portuguese, Slovenian.

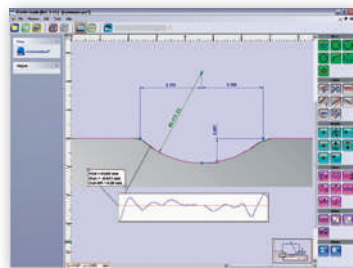

PROFILE STUDIO software

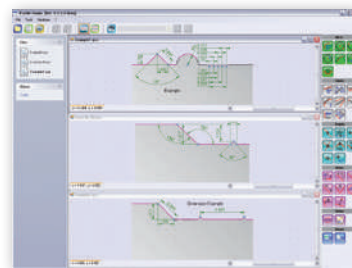

Measurement of geometric elements



No

=



Included in delivery

06960101	PROFILE STUDIO Software	CD with PROFILE STUDIO software
----------	-------------------------	---------------------------------

OPTIONAL ACCESSORIES:

06960102	SB2000 probe for PROFILE SET 2 mm, R = 15 µm, 20°
06960103	Setting master for PROFILE SET 2 mm
06960062	Cable RUGOSURF 10G and RUGOSURF 90G to PC (connector v3)

PROBES FOR TESA RUGOSURF

Standard probes for TESA RUGOSURF roughness gauges, available with different geometries and sizes according to the nature and type of surface being measured.

Standard Probes

Standard probes supplied with TESA surface roughness gauges and SB2000 probes for profile measurement

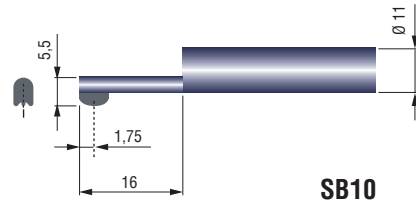

SB10

SB10 probe

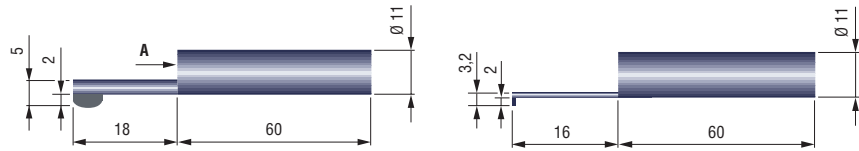

SB60/10 probe with removable skid for RUGOSURF 90G

SB2000 probe without skid



06960036

SB10 standard probe for RUGOSURF 20 and 10G
R = 5 μ m, 90°

06960049

SB60/10 standard probe for RUGOSURF 90G
R = 5 μ m, 90° detachable skid

Unless otherwise stated, 90° diamond tip, radius R = 5 μ m



Optional Probes for RUGOSURF 20 and 10G

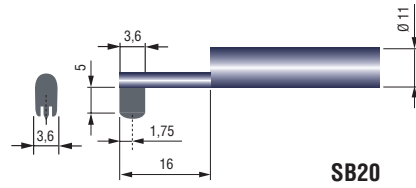

SB20

06960037

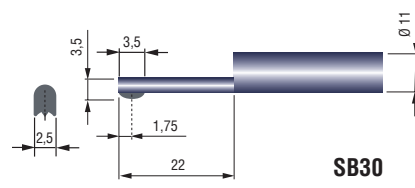

SB30

06960038

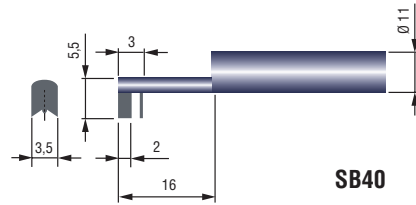

SB40

06960039

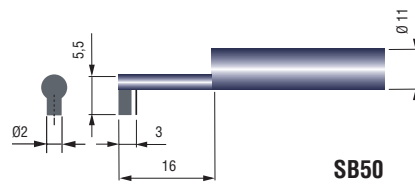

SB50

06960040

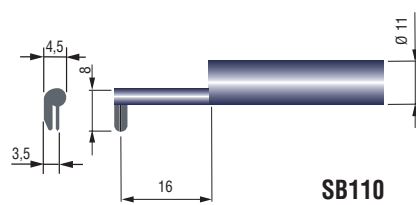

SB110

06960057

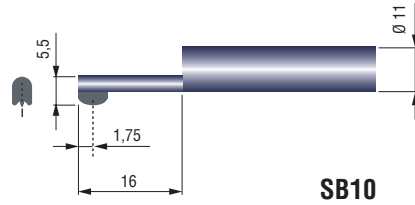

SB10

06960081 SB10 but R = 2 µm

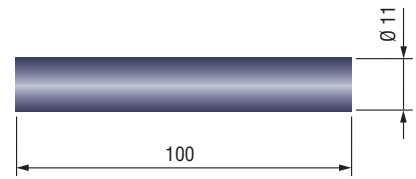

06960056

No	≡
06960037	SB20 probe for RUGOSURF 20 et 10G for grooves of depth < 5 mm
06960038	SB30 probe for RUGOSURF 20 and 10G for small bores of $\varnothing > 4$ mm
06960039	SB40 Probe for RUGOSURF 20 and 10G V-shape for cylinders of $\varnothing > 1$ mm
06960040	SB50 probe for RUGOSURF 20 and 10G for concave surfaces and for measuring at 90° with RUGOSURF 10G
06960057	SB110 probe for RUGOSURF 20 and 10G for concave or convex surfaces, R > 5 mm
06960081	Probe SB10 2µm for RUGOSURF 20 and 10G as SB10 but R = 2 µm
06960056	100 mm extension for probe with skid for RUGOSURF 20, 10G, 90G

Unless otherwise stated, 90° diamond tip, radius R = 5 µm



Optional Probes for RUGOSURF 90G

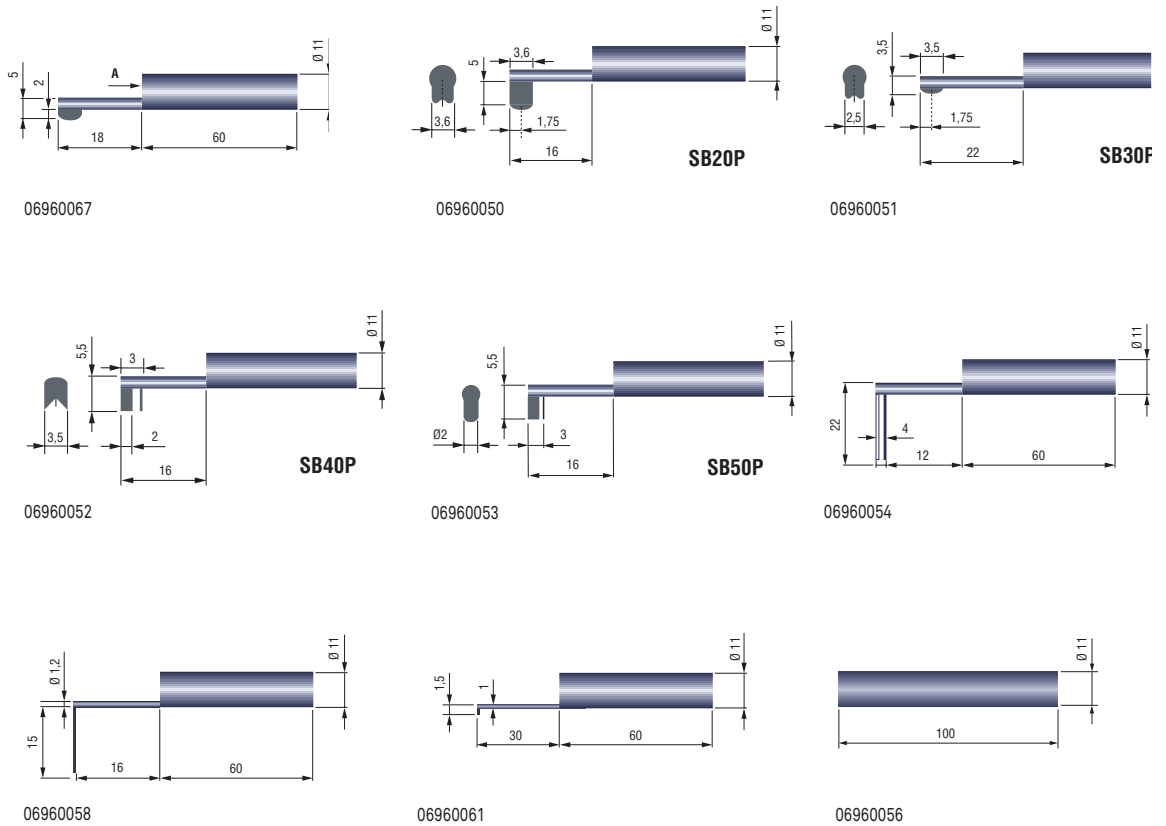

No	≡
06960067	SB60/10 2µm probe for RUGOSURF 90G as SB60/10 but R = 2 µm
06960050	SB20P probe for RUGOSURF 90G for grooves of depth < 5 mm
06960051	SB30P probe for RUGOSURF 90G for small bores with Ø > 4 mm
06960052	SB40P probe for RUGOSURF 90G V-shape for cylinders with Ø > 1 mm
06960053	SB50P probe for RUGOSURF 90G for concave surfaces and for measuring at 90° with RUGOSURF 90G
06960054	SB120P probe for RUGOSURF 90G for grooves of depth < 20 mm
06960058	SB120S probe without skid for RUGOSURF 90G for grooves of depth < 15 mm
06960061	SB60-D2-L30 probe, L = 30 mm for RUGOSURF 90G for small bores of Ø > 2 mm
06960056	100 mm extension for probe with skid for RUGOSURF 20, 10G, 90G

Unless otherwise stated, 90° diamond tip, R = 5 µm



DOT MATRIX PRINTER FOR RUGOSURF

Dot matrix printer for TESA RUGOSURF portable roughness gauges and with built-in batteries, which enable the printing of measured parameters and roughness profiles regardless of the environment and the conditions.

It is also possible to print stored measurements data from the instrument memory.

PR Dot Matrix Printer

Dot matrix printer for TESA RUGOSOFT roughness gauges.

For printing measured parameters, and roughness profiles.

Also for printing measurement data saved in the instrument memory.



PR dot matrix portable printer for RUGOSURF

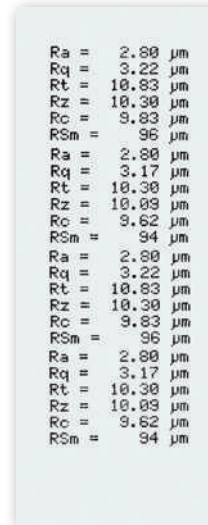

Roughness parameters measured



Measuring results and graphics with header

Roughness profile

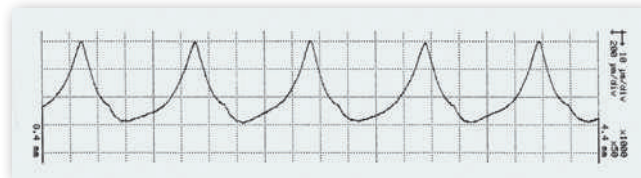

No	=	Characteristics	Dimensions L x W x H, mm	Weight, g	Included in delivery
06960033	Printer for RUGOSURF + cables	Print-out of measured parameters	165 x 120 x H100 mm (6.50 x 4.72 x H3.94 in)	760 g (only printer)	<ul style="list-style-type: none"> Printer Cables for connection to the RUGOSURF Ink ribbon Roll of paper Rechargeable battery User instructions Transport case

DELIVERED WITH THE FOLLOWING ACCESSORIES:

056109	Connecting cable RUGOSURF 10G and RUGOSURF 90G to dot matrix printer
058213	Connecting cable RUGOSURF 20 to dot matrix printer

Accessories for PR Dot Matrix Printer

Ink ribbon for printer

Paper roll

Battery

Transport case



06960044

No

=

06960043	Set of 3x ink ribbons for dot matrix printer
06960044	Set of 10 paper rolls size 57 mm for dot matrix printer
056133	Power supply 100 ÷ 240 V, 50 ÷ 60 Hz, 0,5 Ah, Output 9 V DC, max. 18 W, 5,5 mm connector with EU and US adapter, for PR dot matrix printer
056223	Transport case with foam for internal protection of PR dot matrix printer



ACCESSORIES FOR TESA RUGOSURF, PROFILE SET 2 MM

Accessories for TESA RUGOSURF surface roughness testers, including Ra roughness specimens, granite bases with measuring supports, vertical supports for positioning, etc.

Other Accessories for RUGOSURF

External control for RUGOSURF 10G or 90G

Fixing pin Ø 8mm for universal support for RUGOSURF 20 ou 10G

Vertical positioning supports for RUGOSURF 20 or 10G

Probe holder for RUGOSURF 90G



06960042

No	=
056631	Adjustable vertical positioning supports (2 parts) V-form for cylinder Ø > 100 mm for RUGOSURF 10G
057655	Vertical and adjustable positioning supports (2 parts) V-form for cylinder Ø > 100 mm for RUGOSURF 20
056633	Fixing pin Ø 8 mm for universal support for RUGOSURF 20 and 10G
056641	Probe holder with two positions – blocked position for measuring with a probe without skid – free position for measuring with a probe with skid for RUGOSURF 90G
06960042	External control for RUGOSURF 10G and 90G
06960059	External control with PR dot matrix printer cable for RUGOSURF 10G and 90G

Chargers and Rechargeable Batteries



06960045

No	=
06960045	Battery NiMH 7,2 V, 300 mAh, format PP3, for RUGOSURF 20 et 10G
056224	Battery NiMH 12 V, 1800 mAh, for RUGOSURF 90G
06960046	Charger and power supply 100 ÷ 240 VAC, 50 ÷ 60 Hz, 12 V, 400 ÷ 600 mAh with EU and US adapter for RUGOSURF 20 and 10G
056639	Charger and power supply 100 ÷ 240 VAC, 50 ÷ 60 Hz, 18 V, 2,2 Ah with EU and US adapter for RUGOSURF 90G



Granite Bases with Measuring Support for RUGOSURF

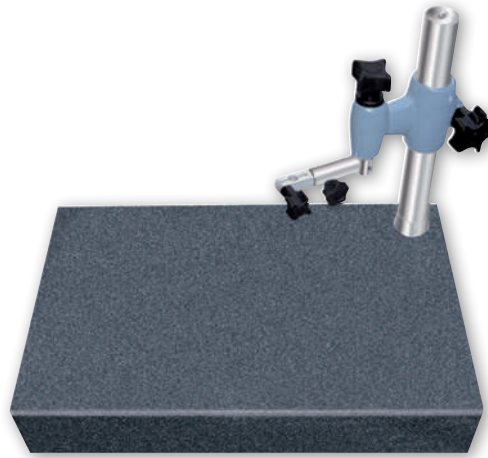

Granite base with measuring support for RUGOSURF 20 or 10G



Granite base with measuring support for RUGOSURF 90G with manual vertical positioning device

No

=

06960035

Granite 400 x 250 mm with vertical support H 150 mm,
25 kg, Grade 0
for Rugosurf 20 and 10G

06960055

Granite 630 x 400 mm with measuring support and manual vertical
positioning device H250mm, 60 kg, Grade 0
for RUGOSURF 90G



Ra Roughness Standards

As per EN ISO 5436-1 standard

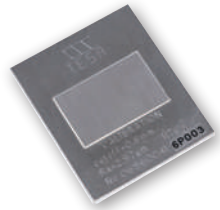

Standard Ra = 2,97 µm

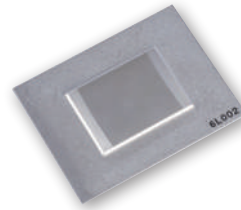

Standard Ra = 1,00 µm



Standard Ra = 0,50 µm

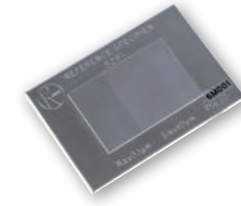

Standard Ra = 0,10 µm

No	=
06960041	Roughness standard Ra = 2,97 µm (117 µin)
06960066	Roughness standard Ra = 1,0 µm (40 µin)
06960065	Roughness standard Ra = 0,5 µm (20 µin)
06960064	Roughness standard Ra = 0,1 µm (4 µin)

Setting Standard for PROFILE SET

For profile measurement

No	=
06960103	Setting master for PROFILE SET 2 mm



ISO 2632
Parts 1 and 2

Rust-resistant
nickel

Specimens for
roughness compar-
ison cannot be
used as reference
ones. Therefore, they
are not suitable for
calibrating surface
roughness testers.

Leather case

RUGOTEST Roughness Comparison Specimens

For tactile and visual comparison of the workpiece surface finish according to various machining processes.



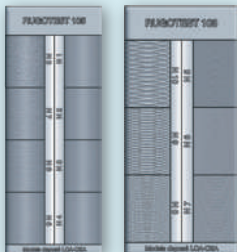

The specimen sets are according to individual machining processes.

ISO 2632-1 and 2632-2

No	=	RUGOTEST N°	Number of samples	ISO roughness parameters	Dimen- sions, mm	g	Included in delivery
081112053	RUGOTEST 1	1	27	M1 - N10	135 x 105	160	Side milling (3 specimens), N8-N9-N10; Face milling (5 specimens), N6-N7-N8-N9-N10; Turning/Planing (5 specimens), N6-N7-N8-N9-N10; Grinding (6 specimens), N2-N3-N4-N5-N6-N7; Lapping (4 specimens), N2-N3-N4-N5; Finish grinding / honing (4 specimens), N1-N2-N3-N4
081112054	RUGOTEST 2	2	16	N6 - N11	120 x 90	160	With samples for shot blasting, spherical coarse grains (3 specimens), N9-N10-N11; With samples for shot blasting, spherical fine grains (6 specimens), N6-N7-N8-N9-N10-N11; With samples for shot blasting, angular coarse grains (3 specimens), N9-N10-N11; With samples for shot blasting, angular fine grains (6 specimens), N6-N7-N8-N9-N10-N11
081112055	RUGOTEST 3	3	18	N6 - N11	120 x 90	190	
081112056	RUGOTEST 4	4	6	N6 - N8	120 x 90	160	
081112057	RUGOTEST 5	5	10	N0 - N4	120 x 90	200	Surface cylindrical form (5 specimens), N0-N1-N2-N3-N4; Surface flat form (5 specimens), N0-N1-N2-N3-N4;
081112058	RUGOTEST 101 Sanding	101	6	N6 - N11	110 x 50	110	
081112059	RUGOTEST 102 Turning	102	6	N5 - N10	110 x 50	105	
081112060	RUGOTEST 103 Face milling	103	6	N5 - N10	110 x 50	110	
081112061	RUGOTEST 104	104	8	N1 - N8	130 x 50	125	
081112062	RUGOTEST 105 Circular grinding	105	8	N1 - N8	130 x 50	130	
081112063	RUGOTEST 107 Spark erosion	107	6	N5 - N10	110 x 50	110	
081112344	RUGOTEST Spark erosion	12	12	Charmilles 12 to 45	127 x 27	60	
081112346	RUGOTEST A4 Set of 4 sets of surface specimens with RUGOTEST 1, 2, 3 and 4				330 x 250	710	
081112345	RUGOTEST A6 Set of 6 sets of surface specimens with RUGOTEST 101, 102, 103, 104, 105, 107				330 x 250	780	



ISO Roughness Parameters	Roughness Ra μm (μin)	Charmilles Roughness Parameters (VDI 3400)	Roughness Ra μm
N0	0,0125 (0.5)	12	0,40
N1	0,025 (1)	15	0,56
N2	0,05 (2)	18	0,80
N3	0,1 (4)	21	1,12
N4	0,2 (8)	24	1,60
N5	0,4 (16)	27	2,24
N6	0,8 (32)	30	3,15
N7	1,6 (63)	33	4,5
N8	3,2 (125)	36	6,3
N9	6,3 (250)	39	9,0
N10	12,5 (500)	42	12,5
N11	25,0 (1000)	45	18,0

-  ISO 2632 Parts 1 and 2
-  Rust-resistant nickel
-  The comparison specimens are not roughness standards. They should not be used for the calibration of surface roughness instruments
-  Leather case



Height Gauges



INSPECTION DURING THE COURSE OF THE MANUFACTURING PROCESS

Height gauges are single-axis handtools made to measure on a surface plate, preferably on granite. The TESA- μ HITE version being offered in this section clearly shows that combining a surface plate with any height gauge can create a complete measuring system.

Providing the necessary versatility, they are well suited for dimensional inspection directly on a machine or a group of machines, usually during the various setting and sampling operations throughout the whole manufacturing process.

They are specially made for checking parts that are difficult to machine due to their critical sizes.

TESA-HITE or TESA MICRO-HITE, whether manually operated or motor-driven, do not require any special skills. Nearly everyone working in the workshop can use them easily.



SCS Calibration Certificate

The newly implemented TESA-HITE and TESA MICRO-HITE production line now also includes its own temperature-controlled laboratory recently certified by the Swiss Accreditation Service (SCS), so that each height gauge comes with a SCS calibration certificate provided free of charge.

The negligible temperature variation along with the use of high-precision step gauges allow the lowest uncertainty of measurement to be achieved during the calibration process.

As a first step, all values needed for automatic compensation for the systematic errors of the finished height gauge through Computer Aided Accuracy (CAA) are captured.

Once conveniently calculated, each single compensation value is then stored in the tool memory so as to allow the automatic calculation of the measured values during calibration.

Finally, the relevant calibration certificate is issued based on the values obtained during a new series of measurements taken at another measuring station, also equipped with step gauges. The applied calibration procedure together with the SCS based certification ensure that every TESA height gauge is traceable to national standards.

Height Gauges – One of TESA's Strengths

TESA offers the largest range of height gauges for reliable one or two-dimensional measurements. End users can choose the most suitable model not only according to the requirements of their metrology applications, but also according to their financial resources.

This wide range goes from the simple height and scribing gauge to the motorised vertical column suitable for high-precision measurements in two coordinate directions.















					1D				2D		Motorized
	Height Gauges	µm (L in m)	Standard Accessory (mm)	Special Accessory (mm)							
	TESA-HITE Magna	8	870	1095	•	•					
	TESA-HITE	2,5 + 4L	870	1095	•	•	•				
	TESA-HITE plus M	2,5 + 3L	860	1085	•	•	•	•	•	•	•
	TESA MICRO-HITE	2 + 3L	1075	1300	•	•	•	•	•		
	TESA MICRO-HITE plus M	1,9 + 1,5L	1075	1300	•	•	•	•	•	•	•
	TESA-µHITE	1 or 2	160	360	•	•					•
	TESA-µHITE + POWER PANEL plus M	1 or 2	160	360	•	•		•	•	•	•
	ETALON height and scribing gauges	40	1000	-	•						



TESA-HITE Magna 400 and 700

Conceived using well-proven TESA technology, both the TESA-HITE magna 400 and 700 models are equipped with the TESA patented magna μ measuring system and can be used in the harshest workshop conditions, especially where the gauges are exposed to splashing liquids of any kind and the penetration of dust particles. Their unique characteristics means that the gauges offer the most favourable price/performance ratio found in the market and constitute an essential tool in the workshop. Robust and reliable, their futuristic design guarantees maximum strength when used near production machines. Each height gauge is provided with a rechargeable battery and can be used to measure height or step dimensions as well as diameters, centre to centre distance of bores or grooves, the size of grooves and much more.

- Wide application range, two sizes available with measuring span to 415 mm/ 16 in or 715 mm/28 in, respectively.
- Electronics totally protected against oil and water splashing or dust particles (IP65).
- Control panel with numerical display to 0,001 / 0,005/0,01 mm or 0,0001/0.0002/ 0.001 in.
- Dynamic probing of the workpiece with a constant measuring force.
- Easiness, high reliability when checking bores or shafts using TESA's unique device for automatic detection of the culmination point – patented.
- Acoustic signal to acknowledge value capture, also conveniently programmable.
- Ability to measure parallelism errors.
- TESA's magnetic system, guaranteeing correct operating even in harsh workshop conditions – patented.
- Large LC display, also with symbols for the measuring functions.
- Zero-setting anywhere within the measuring range.
- PRESET function for entering any given value.
- Metric/inch conversion.
- RS 232 data output.
- SCS calibration certificate provided with each height gauge.

-  Factory standard
-  83 x 49 mm LC display, 7-decade plus minus sign. Also with graphical symbols for all active functions.
-  0,001 mm or 0.0001 in
-  12 mm
-  Magnetic scale, patented system
-  Metric/Inch conversion
-  1,5 \pm 0,5 N (at switch point)
-  500 mm/s 20 in/s
-  Probing head mounted on a ball-bearing, hand wheel for head displacement, fine setting. Head drive carriage can be locked.
-  RS232
-  Rechargeable batteries, 6V
-  ~ 60 h
-  Fixed zero



- Linear expansion
($12 \pm 1,5$) $\times 10^{-6} K^{-1}$
- 100 %
- IP55 or IP65 for both electronics and measuring system (IEC 60529)
- SCS calibration certificate

No	=		
		mm	in
00730047	Height gauge TESA-HITE magna 400	415	16
00730059	Height gauge TESA-HITE magna 700	715	28
CONSISTING OF:		400	700
00760143	Standard probe insert holder	●	●
00760157	Rechargeable battery, 6V	●	●
00760164	Standard probe insert with 5 mm dia. steel ball tip	●	●
00760231	Master piece for establishing the probe constant, nominal dimension 6,350 mm / 0.250 in	●	●
04761054	Mains adapter 100 ÷ 200 VAC / 50 ÷ 60 Hz	●	●
04761055	Cable EU for mains adapter	●	●
04761056	Cable US for mains adapter	●	●
OPTIONAL ACCESSORIES:			
04761052	Extension cable, Sub-D 9p/f to 9p/m, 2 m		
04761063	Sub-D 9p/m to USB cable, 2 m		

Technical Data

Models	TESA-HITE magna 400		TESA-HITE magna 700	
		mm	415	715
	in	16	28	28
With standard accessory	mm	0 ÷ 570	0 ÷ 870	0 ÷ 870
	in	0 ÷ 22	0 ÷ 34	0 ÷ 34
With probe insert holder No. 00760057	mm	0 ÷ 625	0 ÷ 925	0 ÷ 925
	in	0 ÷ 24	0 ÷ 36	0 ÷ 36
With probe insert holder No. S07001622	mm	0 ÷ 795	0 ÷ 1095	0 ÷ 1095
	in	0 ÷ 31	0 ÷ 43	0 ÷ 43
With standard accessory	µm	< 8	< 8	< 8
	in	< 0.0003	< 0.0003	< 0.0003
With standard accessory	On flat surfaces: $2\sigma = < 3\mu\text{m} / < 0.00015\text{ in}$			
	Into bores: $2\sigma = < 5\mu\text{m} / < 0.00020\text{ in}$			
	kg	15	18	18

Standard Accessories

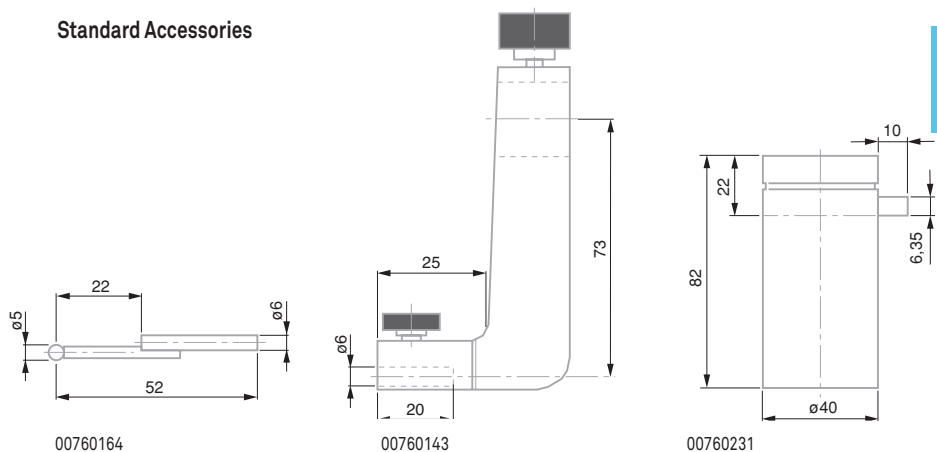

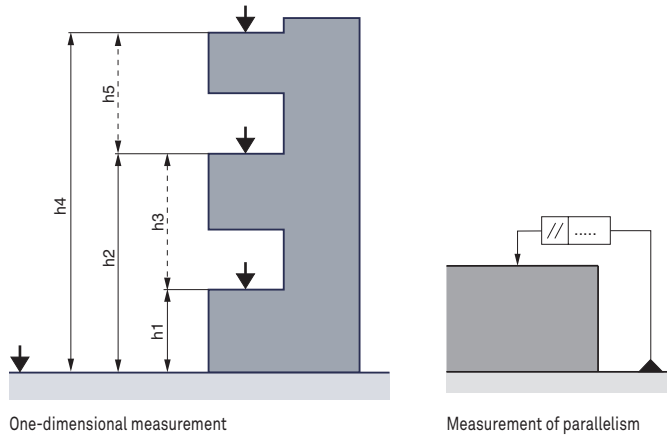

One-dimensional measurement

Measurement of parallelism

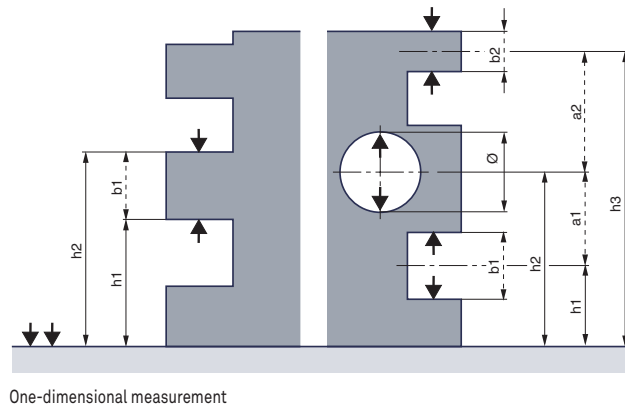

One-dimensional measurement



N Factory standard

000 83 x 49 mm LC display, 7-decade plus minus sign. Also with graphical symbols for all active functions.

000 0,0001 mm or 0.00001 in

B 12 mm

Incremental glass scale, opto-electronic

mm in mm/in conversion

1,5 ± 0,5 N (at switch point)

500 mm/s 20 in/s

A Air-cushion for easy displacement over the surface plate.

***** Probing head mounted on a ball-bearing, hand wheel for head displacement, fine setting. Head drive carriage can be locked.

RS232

Rechargeable batteries, 6V

≈ 60 h

Fixed zero

TESA-HITE 400 / 700

By their robustness and reliability, the TESA-HITE 400 and 700 provided with its optoelectronic incremental rule (TESA patented) measurement system are ideally suited for applications in the workshop.

Their battery power gives them full autonomy.

Each version allows, among other things, the entry height dimensions or staged, the diameter, the distance between two grooves or two holes and groove width.

- Integrated air-bearing for easy displacement across the granite plate.
- Electronics totally protected against oil and water splashing, dust particles (IP65).
- Control panel with numerical display to 0,0001 / 0,001 / 0,01 mm or 0.00001 / 0.0001 / 0.001 in.
- Dynamic probing of the workpiece with a constant measuring force.
- Easiness, high reliability when checking bores or shafts using TESA's unique device for automatic detection of the culmination point – patented.
- Acoustic signal to acknowledge value capture, also conveniently programmable.
- Ability to measure any deviation in parallelism.
- Possible use of a digital sensor for determining perpendicularity errors with stated angle of the linear regression line.
- Patented TESA's opto-electronic system. Long-lasting stability of the glass scale for unbroken high accuracy.
- Large LC display with symbols for the measuring functions.
- Zero-setting anywhere within the measuring range.
- PRESET function for entering any given value.
- Metric/inch conversion.
- RS 232 data output.
- SCS calibration certificate provided with each height gauge.



00730043	TESA-HITE 400	415	16
00730044	TESA-HITE 700	715	28
CONSISTING OF:		400	700
00760143	Standard probe insert holder	●	●
00760157	Rechargeable battery, 6V	●	●
00760219	Master piece for establishing the probe constant, nominal dimension to 6,350 mm / 0.250 in	●	●
00760226	Electric pump for creating the air-cushion beneath the gauge base, already mounted	●	●
00760227	Standard probe insert with shank and 5 mm dia. ball tip in tungsten carbide	●	●
04761054	Mains adapter 100 ÷ 200 VAC / 50 ÷ 60 Hz	●	●
04761055	Cable EU for mains adapter	●	●
04761056	Cable US for mains adapter	●	●
OPTIONAL ACCESSORIES:			
04761052	Extension cable, Sub-D 9p/f to 9p/m, 2 m		
04761063	Sub-D 9p/m to USB cable, 2 m		
04760070	RS port, used to connect a digital sensor for perpendicularity measurement		

- Linear expansion $(12 \pm 1,5) \times 10^{-6} K^{-1}$
- IP40, electronics to IP65 (IEC 60529)
- SCS calibration certificate

Technical data

	Models		TESA-HITE 400	TESA-HITE 700
		mm in	415 16	715 28
	With standard accessory	mm in	0 ÷ 570 0 ÷ 22	0 ÷ 870 0 ÷ 34
	With probe insert holder No. 00760057	mm in	0 ÷ 625 0 ÷ 24	0 ÷ 925 0 ÷ 36
	With probe insert holder No. S07001622	mm in	0 ÷ 795 0 ÷ 31	0 ÷ 1095 0 ÷ 43
	With standard accessory	µm in	(2,5 + 4 L) µm (L in m) (0.0001 + 0.000004 L) in (L in in)	
	With standard accessory		On flat surfaces: $2\sigma < 2 \mu\text{m} / < 0.0001 \text{ in}$ Into bores: $2\sigma < 3 \mu\text{m} / < 0.00015 \text{ in}$	
	Frontal, mechanical	µm in	9 0.00035	13 0.0005
		kg	27	32

Standard Accessories

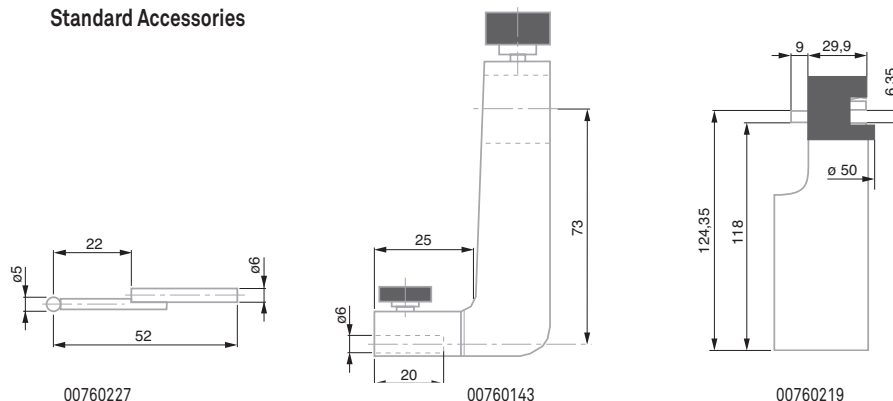

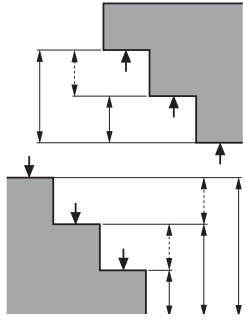

One-dimensional measurement

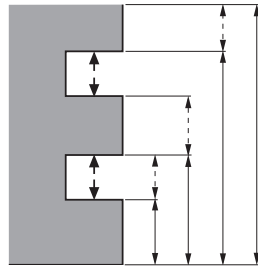

One-dimensional measurement

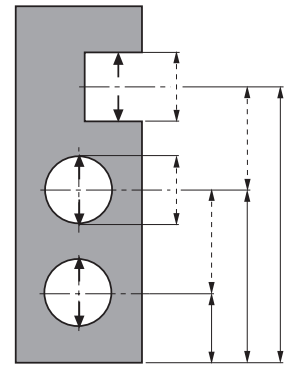

One-dimensional measurement

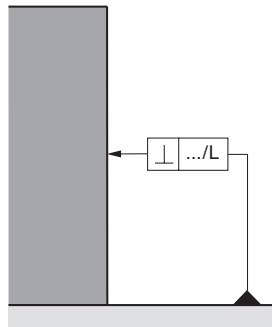

Perpendicularity measurement

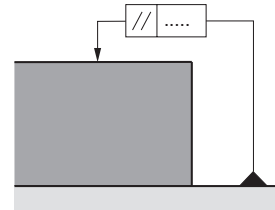

Parallelism measurement



Squareness verification with inductive probe and TWIN-T10 display



TESA-HITE Plus M 400 / 700

The added value of the motorised TESA-HITE plus M 400 / 700 is not only noticeable in their technical features, but also in their ease of use. Combine with the programming function, this solution is ideal for recurrent measurements in the shop floor environment.

Advanced functions allow for complex calculations such as those required for two-axis or perpendicularity measurement. These height gauges with outstanding features offer the most attractive price/performance relationship, making them indispensable for the workshop.

- Wide application range.
- Electronics entirely protected from the penetration of liquids and dust particles.
- Integrated air cushion, mounted control panel.
- Easy, intuitive use of the rotary power control.
- Provide all the measuring functions of a dedicated motorised column, including height, diameter, distance, parallelism, perpendicularity, straightness, angle and 2D measurement besides programming, automatic probing cycles, statistical value processing.
- TESA's patented measuring system, opto-electronic.
- Probe insert holder and inserts compatible with those of TESA MICRO-HITE.
- SCS calibration certificate attached to each height gauge.



- Factory standard
- Dual LC display, 128 x 63 mm in size.
 - Upper display field for length values (7 segments/sign) also with symbols for the functions.
 - Lower full dot display field for perpendicularity and straightness along with symbols for all operator-controlled function keys.
 - 7 segment display plus minus sign for the measured values
- 0,0001 mm or 0.00001 in
- Main display with a size to 12,7 x 6,4 mm or 6,3 x 4,2 mm for auxiliary display
- Incremental glass scale, opto-electronic data capture
- Mm/in conversion
- 1 N
- Air bearing for easy displacement on the granite plate.
- Measuring head mounted on a ball-bearing. Electro-motorised head displacement at varying speeds from 7,5 up to 40 mm/s. Manual displacement: ≤ 600 mm/s. Automatic value acquisition with a constant measuring force.
- RS232
- Rechargeable batteries, 6V
- ≈ 60 h, full charging takes 8 hours
- Fixed zero



- Linear expansion
($12 \pm 1,5$) $\times 10^{-6} K^{-1}$
- IP40, IP65 for the
electronic control
panel (IEC 60529)
- SCS calibration
certificate

No	=		
		mm	in
00730045	TESA-HITE plus M 400	405	16
00730046	TESA-HITE plus M 700	705	27
00730057	TESA-HITE plus M 400 + printer	405	16
00730058	TESA-HITE plus M 700 + printer	705	27
CONSISTING OF:		400	700
00760143	Standard probe insert holder	●	●
00760157	Rechargeable battery, 6V	●	●
00760219	Master piece for establishing the probe constant, nominal dimension to 6,350 mm / 0.250 in	●	●
00760226	Electric pump for creating the air-cushion beneath the gauge base, already mounted	●	●
00760227	Standard probe insert with shank and 5 mm dia. ball tip in tungsten carbide	●	●
04761054	Mains adapter 100 ÷ 200 VAC / 50 ÷ 60 Hz	●	●
04761055	Cable EU for mains adapter	●	●
04761056	Cable US for mains adapter	●	●
OPTIONAL ACCESSORIES:			
04760070	RS port, used to connect a digital sensor for perpendicularity measurement		
04761052	Extension cable, Sub-D 9p/f to 9p/m, 2 m		
04761063	Sub-D 9p/m to USB cable, 2 m		
04765008	Thermal paper 57 MM		

Technical Data

Models		TESA-HITE plus M 400	TESA-HITE plus M 700
	mm	405	705
	in	16	27
	mm	0 ÷ 560	0 ÷ 860
	in	0 ÷ 22	0 ÷ 33
With probe insert holder No. 00760057	mm	0 ÷ 615	0 ÷ 915
	in	0 ÷ 24	0 ÷ 35
With probe insert holder No. S07001622	mm	0 ÷ 785	0 ÷ 1085
	in	0 ÷ 31	0 ÷ 42
	µm	(2,5 + 3 L) µm (L in m)	
	in	(0.0001 + 0.000003 L) in (L in in)	
	With standard accessory		
	On flat surfaces: 2 σ = < 1 µm / < 0.00005 in		
	Into bores: 2 σ = < 2 µm / < 0.0001 in		
	µm	8	12
	in	0.00031	0.00047
	kg	27	32

Standard Accessories

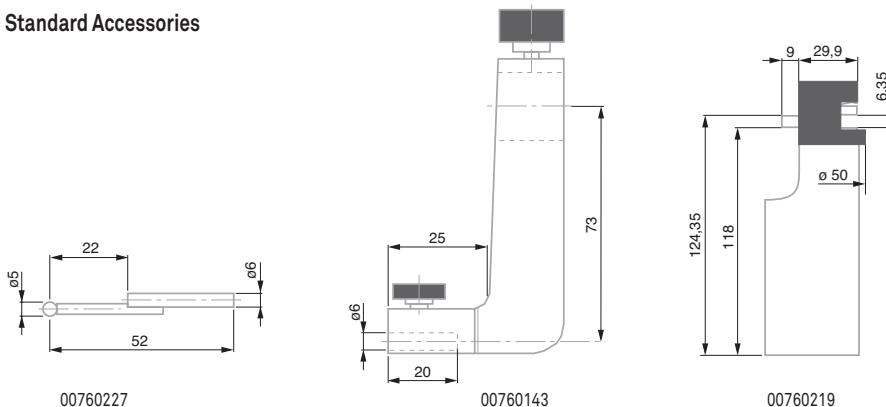

TESA MICRO-HITE 350 / 600 / 900

Autonomous instruments for measurement in one or two coordinate directions of inside dimensions, outside, step, height, depth and distance on geometric elements with flat, parallel or cylindrical surfaces.

The culmination point is automatically entered on the bores and shafts - With memory function "max.", "min." and "max.-min." as dynamic measurement. The use of digital probe TESA IG-13 can also capture perpendicularity, rectitude and parallelism differences, as well as errors of radial and axial runout. Operating results in accordance with ISO 1101.















TESA IG-13

- State-of-the-art concept associated with a high-quality design is the fruit of years of experience in the manufacture of electronic height gauges.
- Ideal for dimensional inspection close to the manufacturing cell. No cumbersome cables to clutter up the working area.
- Fast, simple and reliable probing of the workpiece or holes, especially.
- 3 main gauges available with either a 365, 615 or 920 mm measuring span.
- Numerical display to 0,0005, 0,001, 0,01 and 0,1 mm, or equivalent inch units.
- Extremely accurate measuring of deviations from length, straightness and perpendicularity due to the automatic correction of the bias errors through CAA (Computer Aided Accuracy).
- Coefficient of linear expansion identical to steel ($11,5 \times 10^{-6} \text{ K}^{-1}$).
- POWER PANEL for value processing and output with interactive display to guide the operator.
- No manual calculation.
- 99 workpiece oriented measurement cycles, programmable. Each cycle includes a number of 64 features with related limits of size.
- Built-in printer for result output or possible use of an external printer unit to get a hard copy in A4 format.
- RS232 data output.
- Every height gauge comes with a SCS calibration certificate.

TESA MICRO-HITE – Power and performance



-  Factory standard
-  Incremental glass scale with reference point, dividing period of 20 μm . Opto-electronic value capture (TESA patent).
-  Fixed zero
-  $1,6 \pm 0,25 \text{ N}$
-  300 mm/s 12 in/s
-  Air cushion usable for easy move of the height gauge over the surface plate.
-  RS232, opto-electronic
-  Rechargeable batteries, 6 V, 3,0 Ah or mains adapter
-  ≈ 12 hours for one battery pack; ≈ 2 hours for the pump used to form the air cushion
-  Linear expansion $11,5 \times 10^{-6} \text{ K}^{-1}$
-  IP40 (IEC 60529)
-  Net weight (w/o panel nor battery pack) Main gauges
350: 33 kg 600: 38 kg
900: 45 kg
-  SCS calibration certificate



No	=			
		mm	in	
00730033	SET MICRO-HITE 350	365	14	
00730034	SET MICRO-HITE 600	615	24	
00730035	SET MICRO-HITE 900	920	36	
CONSISTING OF:		350	600	900
00760141	Rechargeable battery pack	●	●	●
00760142	Electric pump for creating the air-cushion beneath the gauge base, already mounted	●	●	●
00760143	Standard probe insert holder	●	●	●
00760150	Master piece for establishing the probe constant, nominal dimension to 20,000 mm / 0.78740 in	●	●	●
00760151	Dust cover for TESA MICRO-HITE 350	●		
00760152	Dust cover for TESA MICRO-HITE 600		●	
00760153	Dust cover for TESA MICRO-HITE 900			●
00760227	Standard probe insert with shank and 5 mm dia. ball tip in tungsten carbide	●	●	●
04761054	Mains adapter 100 ÷ 200 VAC / 50 ÷ 60 Hz	●	●	●
04761055	Cable EU for mains adapter	●	●	●
OPTIONAL ACCESSORIES:				
00760144	Add-on fine adjust device for extra fine movement of the measuring head, complete			
00760157	Rechargeable battery, 6V			
04761023	Cable: miniDIN 8p/m to Sub-D 9p/f, 2m for TT10 and MICRO-HITE manual versions 10/11/12			
04761056	Cable US for mains adapter			

Technical Data

=	Models	MICRO-HITE			
		350	600	900	
		mm	365	615	920
		in	14	24	36
	With standard accessory	mm	0 ÷ 520	0 ÷ 770	0 ÷ 1075
		in	0 ÷ 20	0 ÷ 30	0 ÷ 42
	With probe holder No. 00760057	mm	0 ÷ 575	0 ÷ 825	0 ÷ 1130
		in	0 ÷ 22	0 ÷ 32	0 ÷ 44
	With probe holder No. S07001622	mm	0 ÷ 745	0 ÷ 995	0 ÷ 1300
		in	0 ÷ 29	0 ÷ 39	0 ÷ 51
0	With standard accessory		(2 + 3 L) μm (L in m) (0.0001 + 0.000003 L) in (L in in)		
	With standard accessory		2 σ = ≤ 1 μm / ≤ 0.00005 in		
⊥	Frontal, mechanical	μm	7	9	11
		in	0.00028	0.00035	0.00043
⊥	Frontal and lateral with TESA IG-13 probe	μm	6	8	10
		in	0.00024	0.00031	0.00039

Standard Accessories

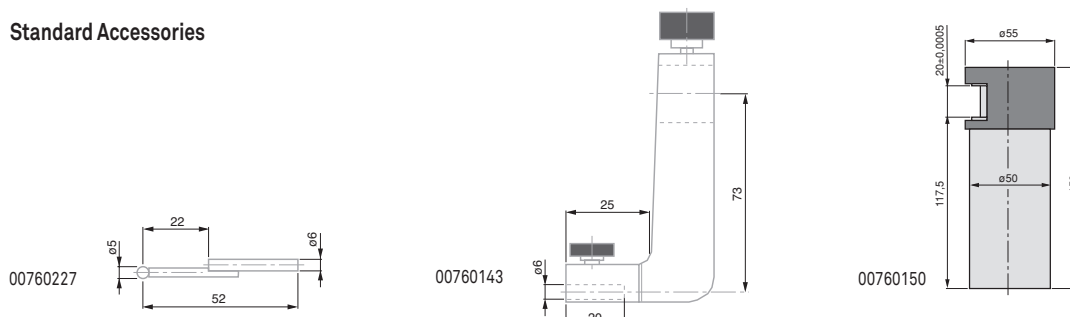

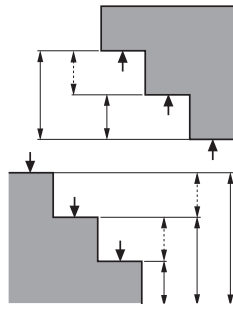

One-dimensional measurement

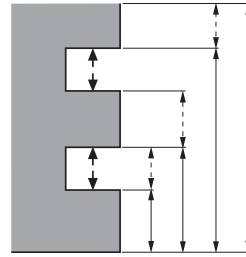

One-dimensional measurement

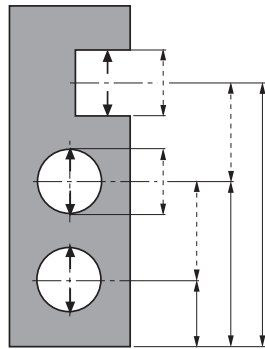

One-dimensional measurement

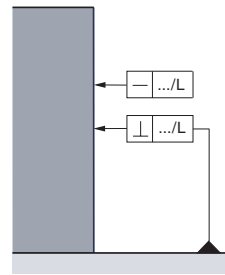

Programme functions for the detection of form and position errors.
With use of a TESA IG-13 digital probe.

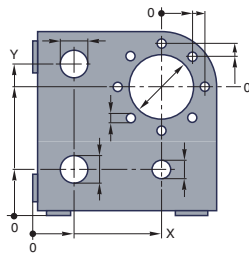

Two-Dimensional Measurement

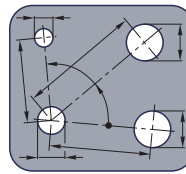

Two-Dimensional Measurement

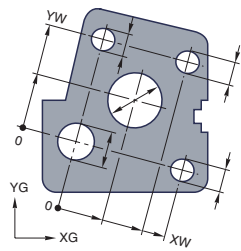

Two-Dimensional Measurement

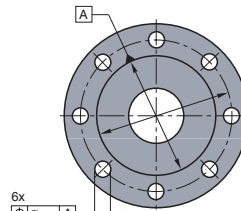

Two-Dimensional Measurement



Control Panel for TESA MICRO-HITE 350 / 600 / 900

Main Display 12,7 x 6,4 mm, 6,3 x secondary display 4,2 mm.

Conversion mm/in

Through TESA MICRO-HITE

IP40 (CEI 60529)

Dual LCD display size 128 x 63 mm.

- Measurement of lengths value display (7 segments / sign) and function symbols (top).
- Measurement of squareness / rectitude display values and symbols (function keys, control by the operator display (points))
- Measured: 7 decades Reduce sign.

PRESET function for entering a given value. Continuous displaying. Manual or automatic triggering of data transfer. Output of pre-defined report with headers in 5 languages plus A4 format using an external printer unit.

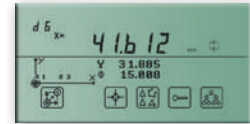

00760163	Power Panel	0,0005 / 0,001 / 0,01 / 0,1	0,00002 / 0,0001 / 0,001 / 0,01 / 0,1
OPTIONAL ACCESSORY:			
04765008	Thermal paper, 57 mm wide		





TESA MICRO-HITE Plus M 350 / 600 / 900

All TESA MICRO-HITE plus M height gauges are unique in that they have exceptional metrological capabilities and can be used intuitively with ease.

This method allows form and position error to be easily and quickly detected by means of a lever-type dial indicator – Check deviations from straightness or parallelism according to ISO 1101 when used in conjunction with TESA IG-13 linked to the Power panel plus M.

- Modular design descending from the successful TESA MICRO-HITE dynasty.
- Also equipped with the unique rotary power control located close to the rugged base. This feature serves for guiding the column that moves on an air cushion, commanding fast motion of the probe insert and triggering all main measuring functions. Its intuitive use allows accurate, easy handling of the column. A simple rotation causes the measuring head to move rapidly, approach the contact point quickly or slowly, probe up- or downward or execute bore measurement.
- Available in three different sizes with a measuring span of 365, 615 or 920 mm.
- Choice between two control panels for value processing and output.
- Metric and inch LC display with a resolution to 0,0001 and 0,001 mm, or inch equivalent.
- Autonomous run through batteries. No cumbersome cable.
- Built-in air bearing for easy displacement over the surface plate.
- Motorised measuring head for fast, accurate probing at each contact point with a constant measuring force.
- TESA μ system for matchless reliability and simplicity.
- High precision through CAA (Computer Aided Accuracy). All correction values stored in the memory still add to the mechanical precision.
- Coefficient of linear expansion matching that of steel ($11,5 \times 10^{-6} K^{-1}$).
- RS232 data output.
- SCS calibration certificate delivered with every height gauge.

- Factory standard
- Incremental glass scale with opto-electronic data acquisition. Grating period: 20 μ m. Op-to-electronic input (TESA Patent)
- 1 N
- Built-in air-bearing for easy move of the column over the surface plate
- Measuring head mounted on a ball-bearing. Motorised head displacement at a varying speed from 7,5 up to 40 mm/s. Manual displacement: ≤ 600 mm/s. Automatic value capture with a constant measuring force.
- Rechargeable 6 V, 3,0 Ah or network adapter 100 \div 240 Vac/50 \div 60 Hz
- ≈ 12 h after 8 h of charging
- Fixed zero



TESA μ System



Perpendicularity using TESA IG-13



Perpendicularity using TESAST



- Linear expansion
11,5 x 10⁻⁶ K⁻¹
- IP40 (CEI 60529)
- Net weight without desks or block batteries. Basic instrument 350: 33 kg, 600: 38 kg, 900: 45 kg
- Calibration certificate SCS

No	=			
		mm	in	
00730063	Set MICRO-HITE plus M 350	365	14	
00730064	Set MICRO-HITE plus M 600	615	24	
00730065	Set MICRO-HITE plus M 900	920	36	
CONSISTING OF:		350	600	900
00760141	Rechargeable battery pack	●	●	●
00760142	Electric pump for creating the air-cushion beneath the gauge base, already mounted	●	●	●
00760143	Standard probe insert holder	●	●	●
00760219	Master piece for establishing the probe constant, nominal dimension to 6,350 mm / 0.250 in	●	●	●
00760151	Dust cover for TESA MICRO-HITE 350	●		
00760152	Dust cover for TESA MICRO-HITE 600		●	
00760153	Dust cover for TESA MICRO-HITE 900			●
00760227	Standard probe insert with shank and 5 mm dia. ball tip in tungsten carbide	●	●	●
04761054	Mains adapter 100 ÷ 200 VAC / 50 ÷ 60 Hz	●	●	●
04761055	Cable EU for mains adapter	●	●	●
04761056	Cable US for mains adapter	●	●	●
OPTIONAL ACCESSORY:				
00760157	Rechargeable battery, 6V			

Technical data

	Models		MICRO-HITE plus M 350	MICRO-HITE plus M 600	MICRO-HITE plus M 900
		mm	365	615	920
		in	14	24	36
	With standard accessory	mm	0 ÷ 520	0 ÷ 770	0 ÷ 1075
		in	0 ÷ 20	0 ÷ 30	0 ÷ 42
	With probe insert holder No. 00760057	mm	0 ÷ 575	0 ÷ 825	0 ÷ 1130
		in	0 ÷ 22	0 ÷ 32	0 ÷ 44
	With probe insert holder No. S07001622	mm	0 ÷ 745	0 ÷ 995	0 ÷ 1300
		in	0 ÷ 29	0 ÷ 39	0 ÷ 51
	With standard accessory		(1,9 + 1,5 L) μm (L in m) (0.0001 + 0.0000015 L) in (L in in)		
	With standard accessory		On flat surfaces: 2σ ≤ 0,5 μm / ≤ 0.000025 in Into bores: 2σ ≤ 1 μm / ≤ 0.00005 in		
	Frontal, mechanical	μm	5	7	9
	Frontal and lateral using TESA IG-13	in	0,00020	0,00028	0,00035

Standard Accessories

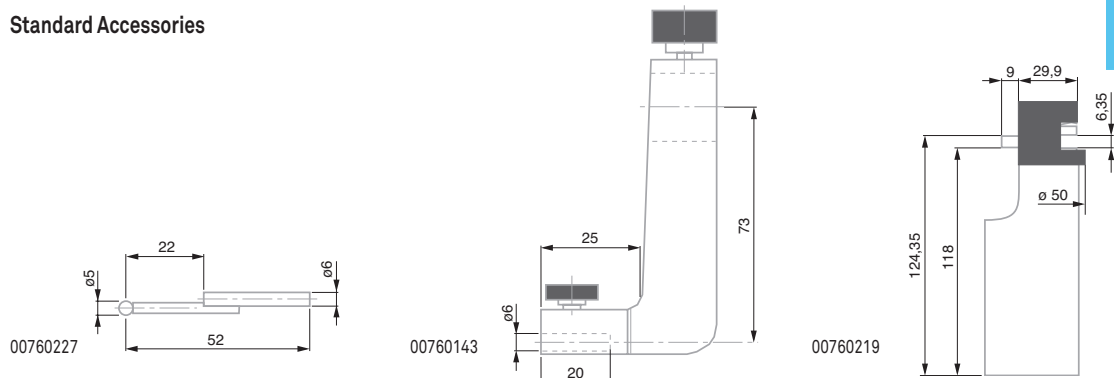

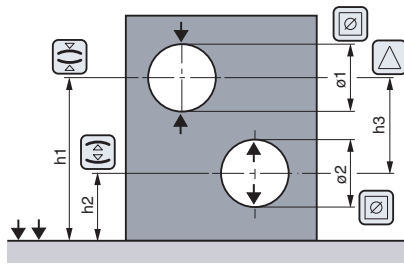

Measurement with change of the probe direction
Probe constant included, considering the culmination point

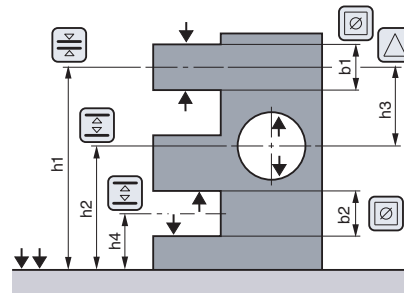

Measurement with change of the probe direction
Probe constant included, disregarding the culmination point

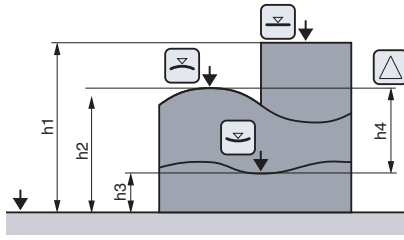

Measurement without change of the probe direction
Probe constant excluded

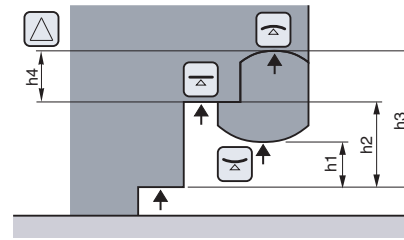

Measurement without change of the probe direction
Probe constant excluded

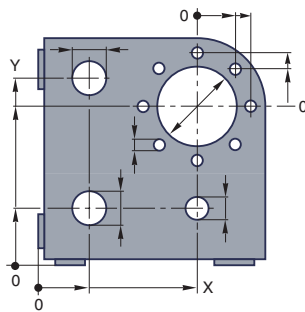

Two-Dimensional Measurement

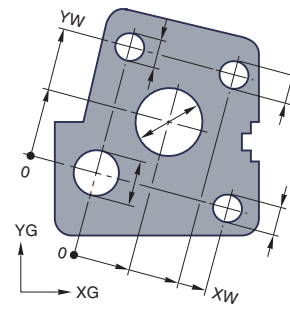

Two-Dimensional Measurement

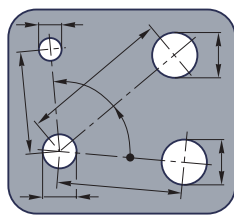

Two-Dimensional Measurement

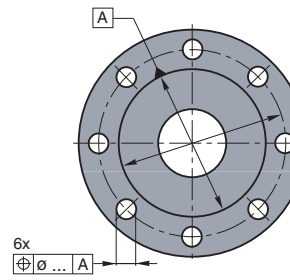

Two-Dimensional Measurement

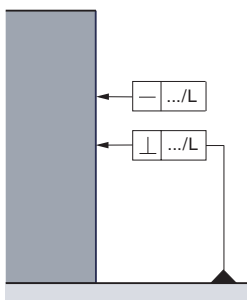

Measurement of form and position errors

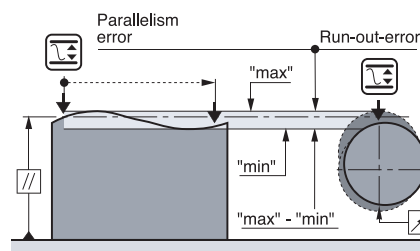

Measurement of form and position errors



12,7 x 6,4 mm main display, 6,3 x 4,2 or 3,8 x 2,9 mm auxiliary display

mm/in conversion

Via TESA MICRO-HITE plus M

IP50 (IEC 60529)

Bidirectional RS232, optoelectronic and Centronics

LC dual display, 128 x 63 mm in size.

- Length measurement: 7-segment/digit upper display field for values plus symbols for the functions.
- Straightness or perpendicularity measurement: display field for values plus symbols (function keys). Operator controlled operations (full dot display).
- Measured values: 7-decade display plus minus sign.

PRESET function for entering a given value. Acoustic signal. Manual or automatic triggering of data transfer. Output of predefined reports with headers in 5 languages (plus a programmable one) using an external printer unit (A4 format).

Control Panels for TESA MICRO-HITE Plus M 350 / 600 / 900



00760220	Power Panel for MICRO-HITE plus M with printer	0,0001 / 0,001 / 0,01	0.00001 / 0.0001 / 0.001
00760221	Power Panel for MICRO-HITE plus M	0,0001 / 0,001 / 0,01	0.00001 / 0.0001 / 0.001
OPTIONAL ACCESSORIES:			
04765008	Thermal paper, 57 mm wide		
04761052	Extension cable, Sub-D 9p/f to 9p/m, 2 m		
04761063	Sub-D 9p/m to USB cable, 2 m		



TESA IG-13 Probe Set for Perpendicularity Measurement

- Factory standard
- 13 mm / 0.51 in
- 1 µm
- 0,45 N at zero
0,75 N at stop

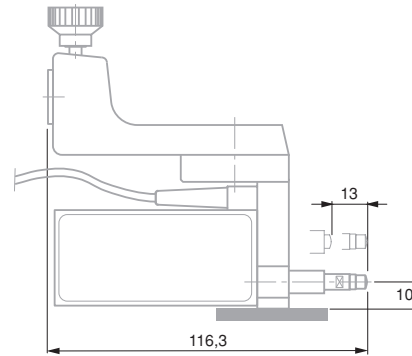

00760140

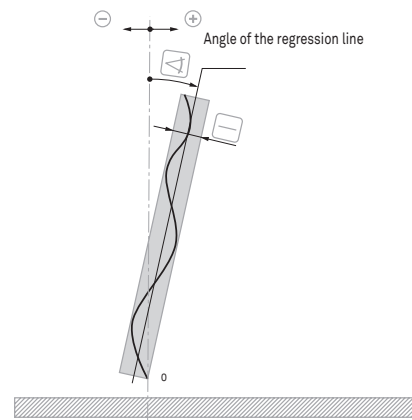
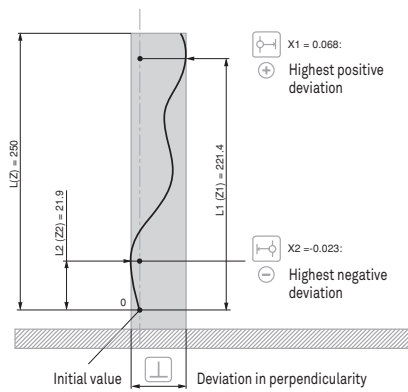

00760140	TESA IG-13 Probe set
CONSISTING OF:	
00760138	TESA IG-13 Attachment
00760139	TESA IG-13 Digital probe
OPTIONAL ACCESSORIES:	
01960005	Retraction lever
04761047	Connecting cable IG-13/Power Panel plus M 1 m (mini-DIN)



- Factory standard
- 100 mm / 4 in
- 0 to 160 mm / 0 to 6.3 in
- 0,0001 mm or 0.00001 in
- Incremental glass scale with opto-electronic data acquisition. Grating period: 20 µm.
- Accuracy class according to DIN 876, Part 1
- finely lapped
- Measuring table (L x P x H) 200 x 300 x 50 mm, Ø column 50 x 300 mm.
- Granite measuring table; dull-chrome plated steel column, hardened and ground.
- 0,63 ± 0,1 N and 1 ± 0,1 N, switchable. Electromotorised activation.
- Numerical interval to 0,001 mm / 0,0001 in = 10 mm/s; to 0,0001 mm / 0,00001 in = 5 mm/s; fast displacement = 30 mm/s
- Electro-motorised gauge head displacement; can also be moved manually.
- Via the control panel
- Linear expansion 11,5 x 10⁻⁶ K⁻¹
- Fixed zero

TESA-µHITE

Compact design with measuring stand included – Sensor equipped with a system for coaxial measuring according to the Abbe principle or using an offset probe relative to the gauge axis. Measures internal, external, height, depth, step and distance dimensions on geometric elements having either a flat, parallel or cylindrical surface – Automatic detection of the culminating point on bores or shafts – Dynamic probing with memory functions "max.", "min." and "max.-min.". The whole system provides the best solution for measuring straightness, flatness and parallelism or inspecting axial and radial runouts depending on the chosen tool configuration.

- Ideal for workpiece inspection close to the production area.
- 100 mm measuring span.
- 0,001 mm and 0,0001 mm or 0.0001 in and 0.00001 in scales intervals.
- Max. perm. error as low as 2 µm (or 1 µm when checking coaxiality).
- Integrated temperature sensor so that the coefficient of linear expansion of each gauge unit matches that of steel (11,5 x 10⁻⁶ K⁻¹).
- Motorised measuring head for fast probing at each point.
- Automatic value capture, controlled over the stability of the measuring force, but also all measured values.
- Constant measuring force through the motor-driven actuator. Switchable.
- No manual calculation needed.
- RS232 data output with direct connection to TESA PRINTER SPC.
- Memory capacity for 99 single values.

Accuracy

Insert's position relative to the axis of the measuring bolt				
	µm	in	µm	in
Coaxial	1,0	0.00005	0,5	0.00002
Offset	2,0	0.0001	1,0	0.00004

Applicable with used standard accessory

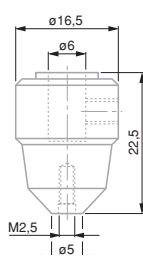
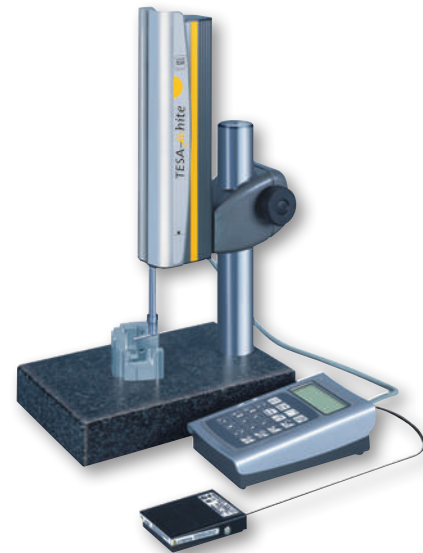

00760195

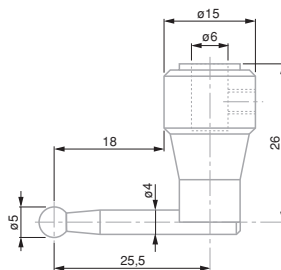

00760197

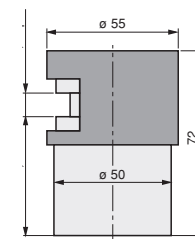

00760192

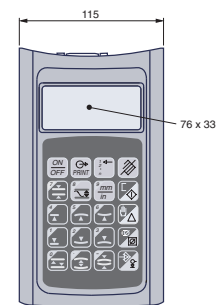

00760204

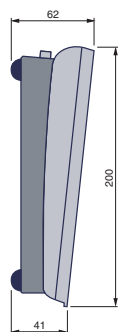

No	TESA-μHITE	mm 0 ÷ 160	in 0 ÷ 6,3	μm Coaxial tip: 1,0 off-centre tip 2,0	μm / in Coaxial tip: 0,5 / 0.00002; off-centre tip 1,0 / 0,00004
----	------------	---------------	---------------	--	---

CONSISTING OF:

- 00760203 TESA measuring support, granite measuring table, size 200 x 300 x 50 mm
- 00730054 TESA-μHITE electronic measuring equipment

CONSISTING OF:

- 038407 1 plastic case
- 00730050 TESA-μHITE probe
- 00760191 Connecting cable Panel / TESA-μHITE
- 00760192 Master piece for establishing the probe constant, nominal dimension 10 mm / 0.39370 in
- 00760195 Axial insert holder M2,5
- 00760197 Probe insert with a 5 mm dia. tungsten carbide ball tip, offset
- 00760204 Control panel, to be connected to TESA-μHITE
- 03510002 Measuring insert TN10W
- 04761054 Mains adapter 100 ÷ 200 VAC / 50 ÷ 60 Hz
- 04761055 Cable EU for mains adapter
- 04761056 Cable US for mains adapter

OPTIONAL ACCESSORIES:

- 00760186 Set of probe inserts for TESA-μHITE
- 04761052 Extension cable, Sub-D 9p/f to 9p/m, 2 m
- 04761063 Sub-D 9p/m to USB cable, 2 m

IP50 (IEC 60529)

Net weight 16,2 kg (measuring support No. 00760203), net weight 2,6 kg (TESA-μHITE No. 00730050), net weight 1,45 kg (control panel No. 00760204 with cable No. 00760191)

SCS calibration certificate

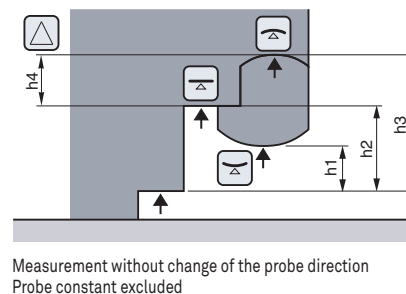
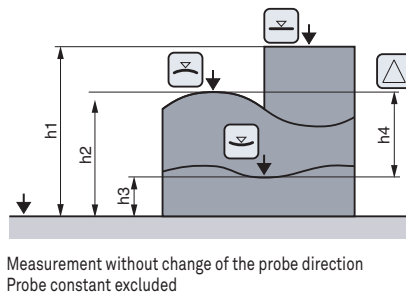

Measurement with change of the probe direction
Probe constant included, considering the culmination point

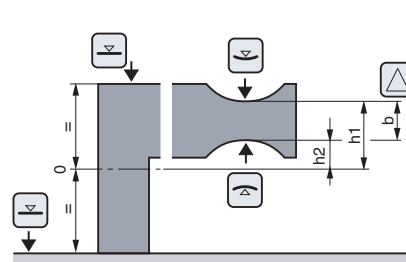
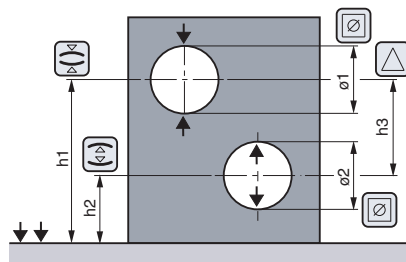

Measurement with change of the probe direction
Probe constant included, disregarding the culmination point

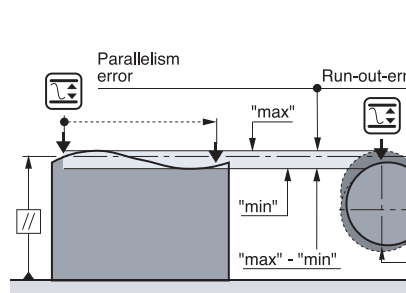
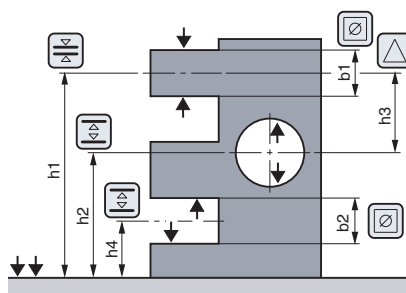

Optional Accessories for TESA- μ Hite

No	Icon	Description
00760194		Axial probe holder for probe inserts with a M1,4 thread
00760196		Axial probe holder for probe inserts with a M3 thread
00760198		Radial probe holder with a 4 mm dia. mounting bore
00760199		Universal probe insert holder with a 4 mm dia. clamping shank (used in conjunction with radial probe holder No. 00760198). M1,4 plus M3 threads (2 x 2) for the probe inserts
00760200		Probe insert with a 5 mm dia. tungsten carbide ball tip. Also with a 4 mm dia. fixing rod for use with radial probe holder insert No. 00760198.
00760201		Probe insert with a 3 mm dia. tungsten carbide ball tip. Also with a 4 mm dia. fixing rod for use with radial probe holder No. 00760198.
00760202		Spare batteries for control panel No. 00760204, 6 Vdc/1,2 Ah.
00760207		Swivel support for control panel

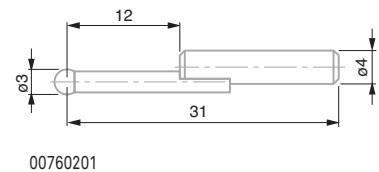
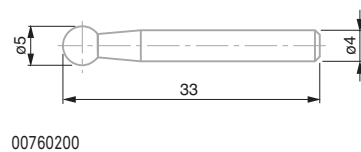
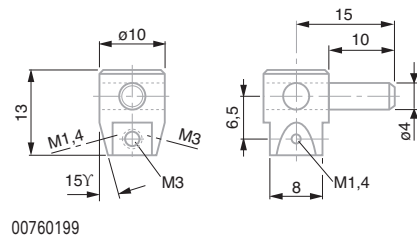
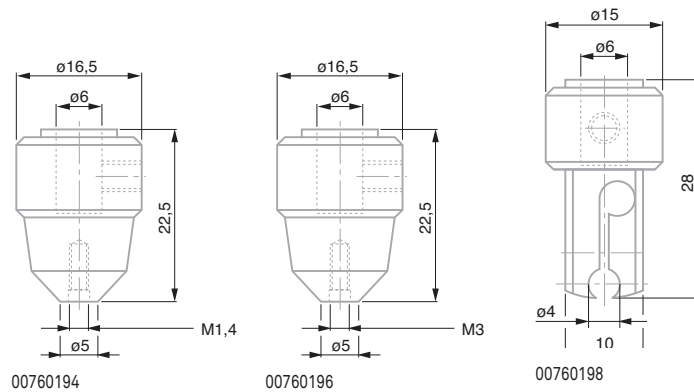

Sets of Accessories for Height Gauges



No	=
00760232	Starter accessory kit with 4 elements for TESA Height Gauges
<i>CONSISTING OF:</i>	
00760061	Probe insert with a 3 mm dia. carbide ball tip
00760075	Probe insert with a carbide disc tip E = 2 mm / Ø 14 mm for grooves, slots, centering shoulders etc.
00760082	2 mm dia. probe insert with a small cyl. carbide face
00760094	Probe inserts with a stainless steel shank, hardened. Also with one flat and one spherical carbide measuring face. Interchangeable shank.
059215	Plastic box

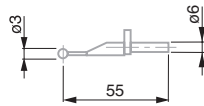

00760061

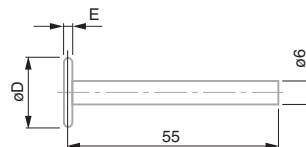

00760075

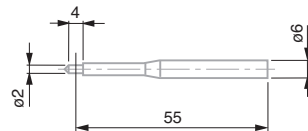

00760082

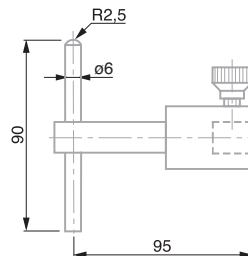

00760094



Sets of Accessories for Height Gauges

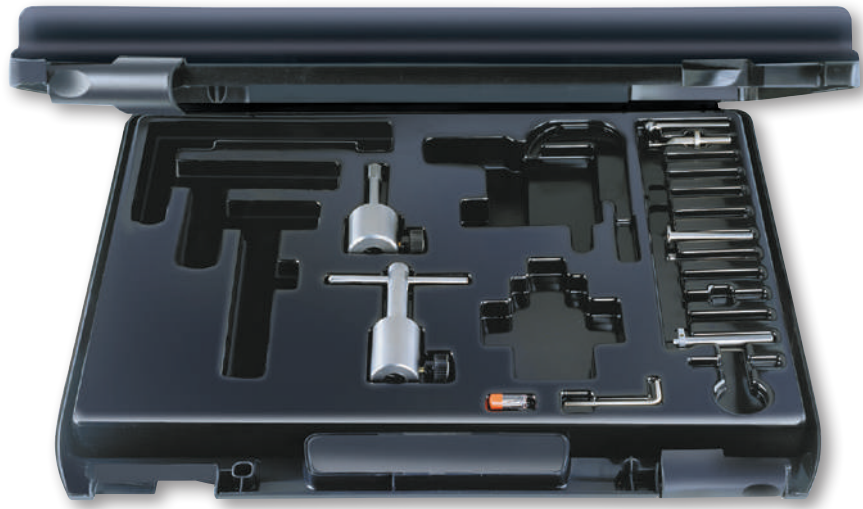

00760173 Starter accessory kit with 8 elements for TESA Height Gauges

CONSISTING OF:

- 00760061** Probe insert with a 3 mm dia. carbide ball tip
- 00760060** Probe insert with a 10 mm dia. carbide ball tip
- 00760075** Probe insert with a carbide disc tip E = 2 mm / Ø 14 mm for grooves, slots, centering shoulders etc.
- 00760093** Probe insert with a cylindrical, tungsten carbide measuring face (10 mm dia., 12 mm long). Stainless steel body, hardened.
- 00760094** Probe inserts with a stainless steel shank, hardened. Also with one flat and one spherical carbide measuring face. Interchangeable shank.
- 00760228** Probe insert dia. 1 mm with shank and ball tip in tungsten carbide
- 00760229** Probe insert dia. 2 mm with shank and ball tip in tungsten carbide
- 00760230** Probe insert dia. 3 mm with shank and ball tip in tungsten carbide

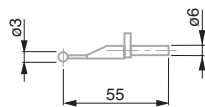

00760061

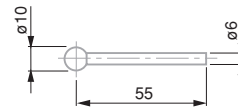

00760060

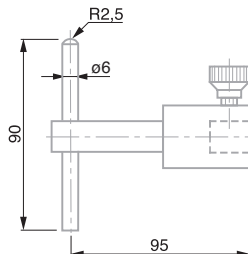

00760094

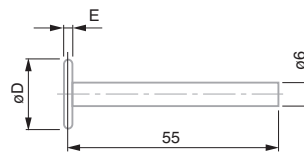

00760075

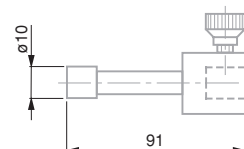

00760093

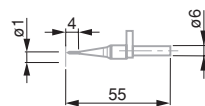

00760228

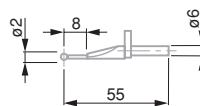

00760229

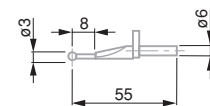

00760230



Sets of Accessories for Height Gauges

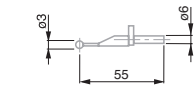

00760061

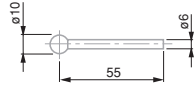

00760060

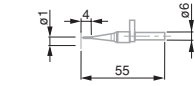

00760228

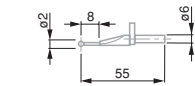

00760229

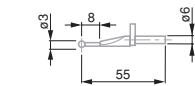

00760230

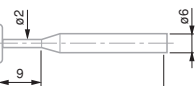

00760074

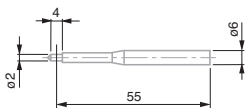

00760082

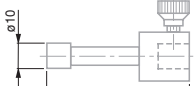

00760093

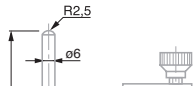

00760094



00760148 Full accessory set with 17 elements for TESA Height Gauges

CONSISTING OF:

- 00760057** Probe insert holder for extending the application range
- 00760060** Probe insert with a 10 mm dia. carbide ball tip
- 00760061** Probe insert with a 3 mm dia. carbide ball tip
- 00760066** Probe insert \varnothing 2,2 mm (for M3 to M16 threads) with carbide, barrel-shaped measuring faces for cylindrical bores as well as for determining the position of metric inside threads (or similar).
- 00760067** Probe insert \varnothing 4,5 mm (for M6 to M48 threads) with carbide, barrel-shaped measuring faces for cylindrical bores as well as for determining the position of metric inside threads (or similar).
- 00760068** Probe insert \varnothing 9,7 mm (for M12 to M150 threads) with carbide, barrel-shaped measuring faces for cylindrical bores as well as for determining the position of metric inside threads (or similar).
- 00760074** Probe insert with a carbide disc tip E = 1 mm / \varnothing 4,5 mm for grooves, slots, centering shoulders etc.
- 00760075** Probe insert with a carbide disc tip E = 2 mm / \varnothing 14 mm for grooves, slots, centering shoulders etc.
- 00760076** Probe insert with a carbide disc tip E = 3 mm / \varnothing 19 mm for grooves, slots, centering shoulders etc.
- 00760082** 2 mm dia. probe insert with a small cyl. carbide face
- 00760086** Probe insert holder for depth up to 110 mm (L = 75 mm)
- 00760087** Probe insert holder for depth up to 185 mm (L = 150 mm)
- 00760093** Probe insert with a cylindrical, tungsten carbide measuring face (\varnothing 10 mm, length 12 mm); stainless steel body, hardened
- 00760094** Probe inserts with a stainless steel shank, hardened. Also with one flat and one spherical carbide measuring face. Interchangeable shank.
- 00760228** Probe insert dia. 1 mm with shank and ball tip in tungsten carbide
- 00760229** Probe insert dia. 2 mm with shank and ball tip in tungsten carbide
- 00760230** Probe insert dia. 3 mm with shank and ball tip in tungsten carbide

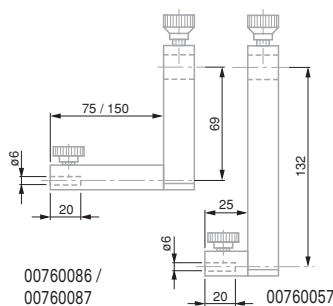

00760086 / 00760087

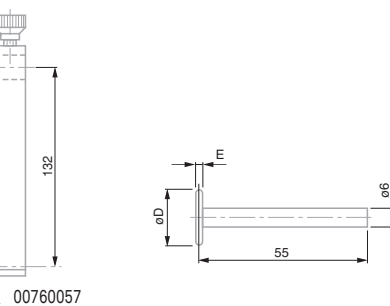

00760075 / 00760076

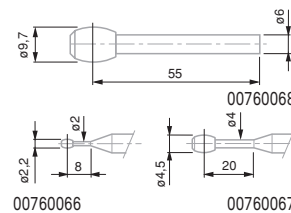

00760066

00760067



Sets of Accessories for Height Gauges



00760175 Set of probe inserts for TESA-HITE, TESA-HITE plus M, TESA-HITE magna, MICRO-HITE and MICRO-HITE plus M

CONSISTING OF:

- 00760177** Probe insert holder
- 00760178** Hardened steel rod for grooves, centring shoulders, blind bores etc, angled through 8°
- 00760179** Tungsten carbide cylindrical rod for depth measurement
- 00760180** Probe inserts with a 0,9 mm dia. hardened steel ball tip
- 00760181** Probe inserts with a 1,9 mm dia. hardened steel ball tip
- 00760182** Probe inserts with a 1,9 mm dia. hardened steel ball tip
- 00760183** Hardened steel probe insert with a cone-shaped measuring face, 8 mm dia.
- 00760184** Extension, 20 mm, with a M3 thread for inserts with M3 thread
- 00760185** Extension, 20 mm, with a M3 thread for inserts with M2,5 thread

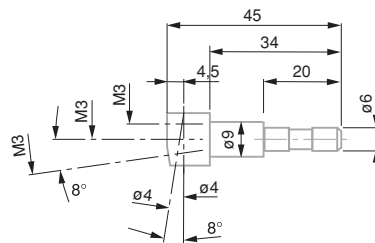

00760177

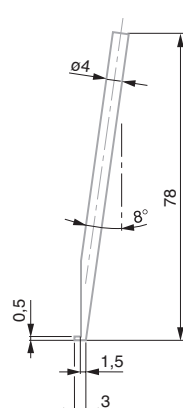

00760178

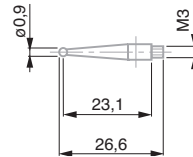

00760180

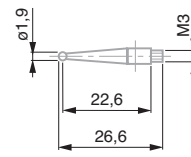

00760181

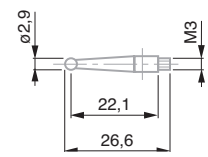

00760182

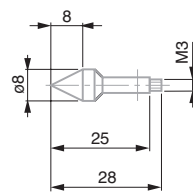

00760183

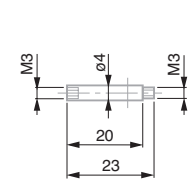

00760184

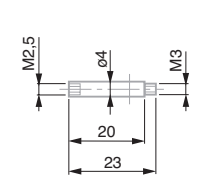

00760185

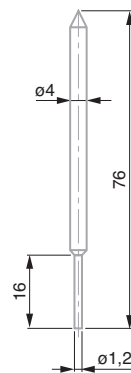

00760179

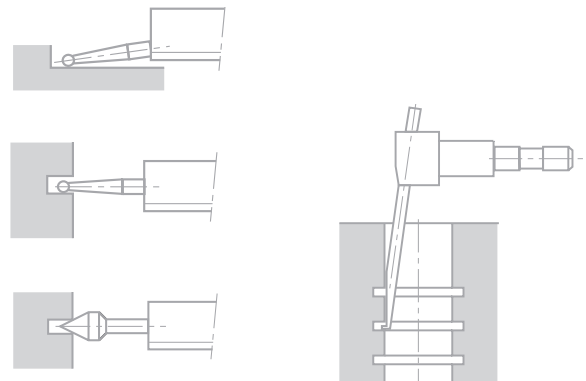

Sets of Accessories for Height Gauges



00760186 Set of probe inserts for TESA- μ HITE

CONSISTING OF:

- 00760178** Hardened steel rod for grooves, centring shoulders, blind bores etc, angled through 8°
- 00760179** Tungsten carbide cylindrical rod for depth measurement
- 00760180** Probe inserts with a 0,9 mm dia. hardened steel ball tip
- 00760181** Probe inserts with a 1,9 mm dia. hardened steel ball tip
- 00760182** Probe inserts with a 2,9 mm dia. hardened steel ball tip
- 00760183** Hardened steel probe insert with a cone-shaped measuring face, 8 mm dia.
- 00760184** Extension, 20 mm, with a M3 thread for inserts with M3 thread
- 00760185** Extension, 20 mm, with a M3 thread for inserts with M2,5 thread
- 00760187** Probe insert holder

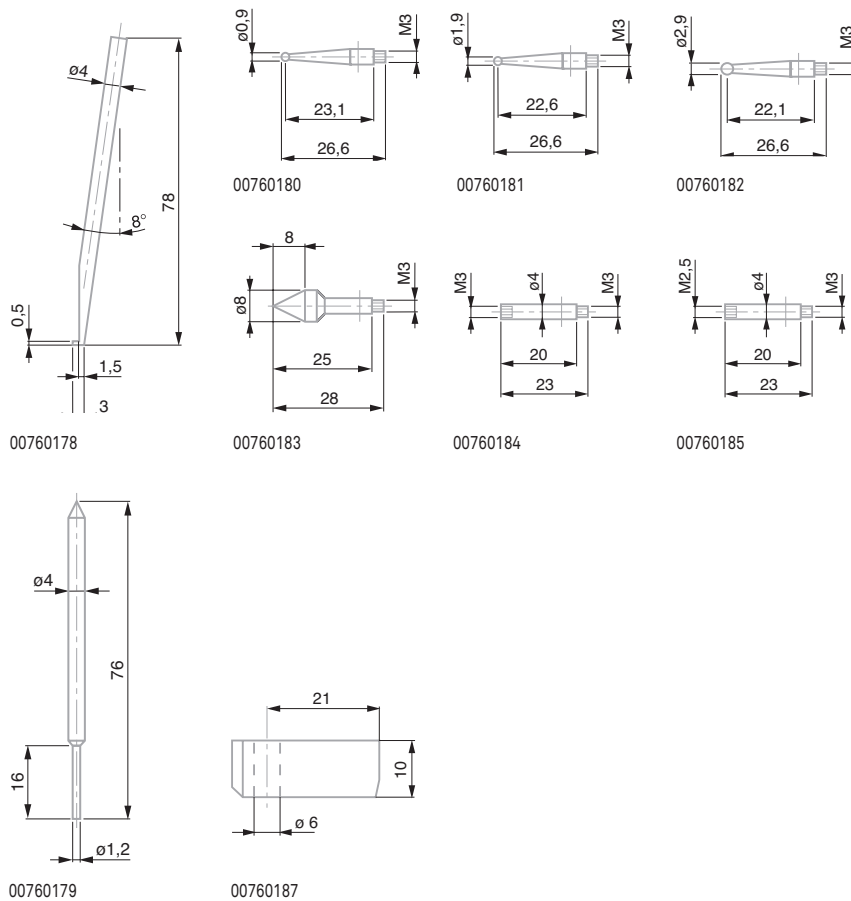

Probe Holder No. 00760223 for Inserts with 8 mm Diameter



00760223 Probe holder for inserts with 8 mm diameter

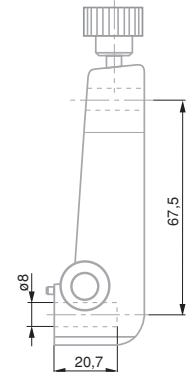

Optional Accessories for Use with Insert Holder No. 00760223



- 0071684815 Probe insert with a 4 mm dia. tungsten carbide ball tip
- 0071684816 Probe insert with a 6 mm dia. tungsten carbide ball tip
- 0071684817 Long probe insert with a 10 mm dia. tungsten carbide ball tip
- 0071684818 Probe insert with a 1 mm dia. steel tip, hardened. Also with adjustable shank for depth measurement.
- 0071684819 Probe insert with cone-shaped measuring face in hardened steel for $\varnothing 5 \div 20$ mm
- 0071684820 Probe insert with cylindrical measuring face in hardened steel, $\varnothing 10$ mm, 12 mm long
- 0071684822 Probe insert with cone-shaped measuring face in hardened steel, $\varnothing 0,5 \div 5,5$ mm
- 0071684825 Probe insert with a 6 mm dia. tungsten carbide ball tip
- 0071684826 Attachment for interchangeable inserts with M1,4 thread. Supplied with 1 insert No. 01860201 having a 1 mm dia. carbide ball tip.
- 0071684827 Probe insert with disc-shaped face $\varnothing 12$ mm, 3 mm wide
- 0071684828 Attachment for interchangeable insert with M1,4 thread. Supplied with 2 probe inserts No. 0186020 having a 2 mm dia. carbide ball tip
- 0071684829 Probe insert with a 10 mm dia. tungsten carbide ball tip
- 0071684832 Probe insert with a 8 mm dia. tungsten carbide ball tip

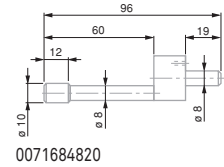

0071684820

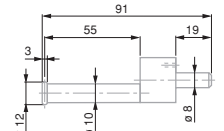

0071684827

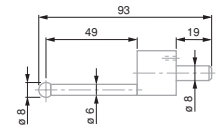

0071684832

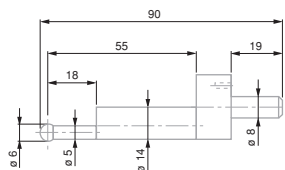

0071684825

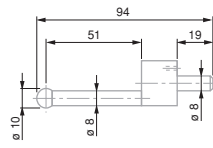

0071684829

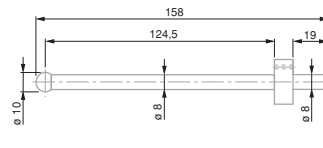

0071684817

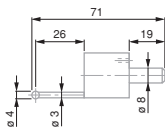

0071684815

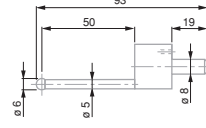

0071684816

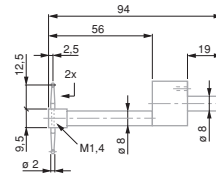

0071684828

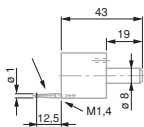

0071684826

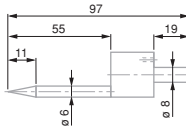

0071684822

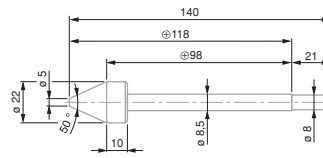

0071684819

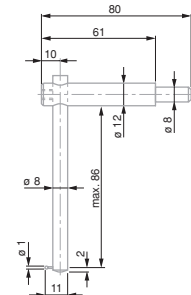

0071684818



Accessories for Measuring Perpendicularity by Means of a Dial Test Indicator

Used with TESA MICRO-HITE plus M, TESA MICRO-HITE, TESA-HITE 400/ 700 and TESA-HITE plus M 400/ 700.

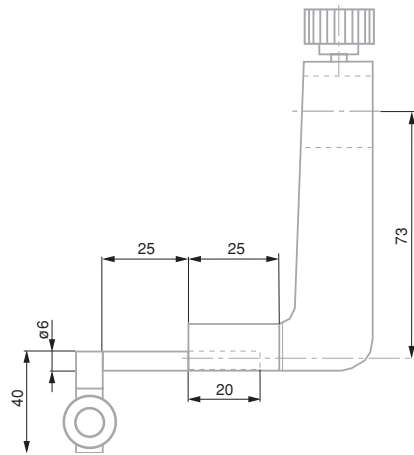

00760222 Probe insert holder for a dial test indicator (lever-type)



- Factory standard
- Floating zero
- DIN 862
For lengths up to
600 mm = 30 µm
1000 mm = 40 µm
- Steel base,
hardened
- Slider with inter-
changeable scriber.
Also with back
mounted clamping
holder having
a 8 mm diameter.
Slider with locking
screw and fine
adjust device.
Base has a ground
face with dust
grooves. Top face
also ground.
- Preset and Hold
functions



ETALON Height and Scribing Gauges with Digital Display

Electronic height and scribing gauges

- Resolution to 0,01 mm/0.005 in
- RS232 interface

No	mm	in	Column, mm	Base (L x H x W) mm
07739001	0 ÷ 300	0 ÷ 12	25 x 6	60 x 40 x 100
07739002	0 ÷ 600	0 ÷ 24	30 x 12	110 x 50 x 160
07739003	0 ÷ 1000	0 ÷ 40	30 x 12	110 x 50 x 160

Accessories for ETALON Height and Scribing Gauges with Digital Display



07769005



07769006

No		Suitable for models	Length, mm
07769001	Scriber for 300 mm length	65	300
07769003	Scriber for 6 to 1000 mm, length	75	600, 1000
07769005	Holder to replace the scriber		
07769006	Rotating and tilting version with a 8 mm dia. shank. To be used with No. 07769005		





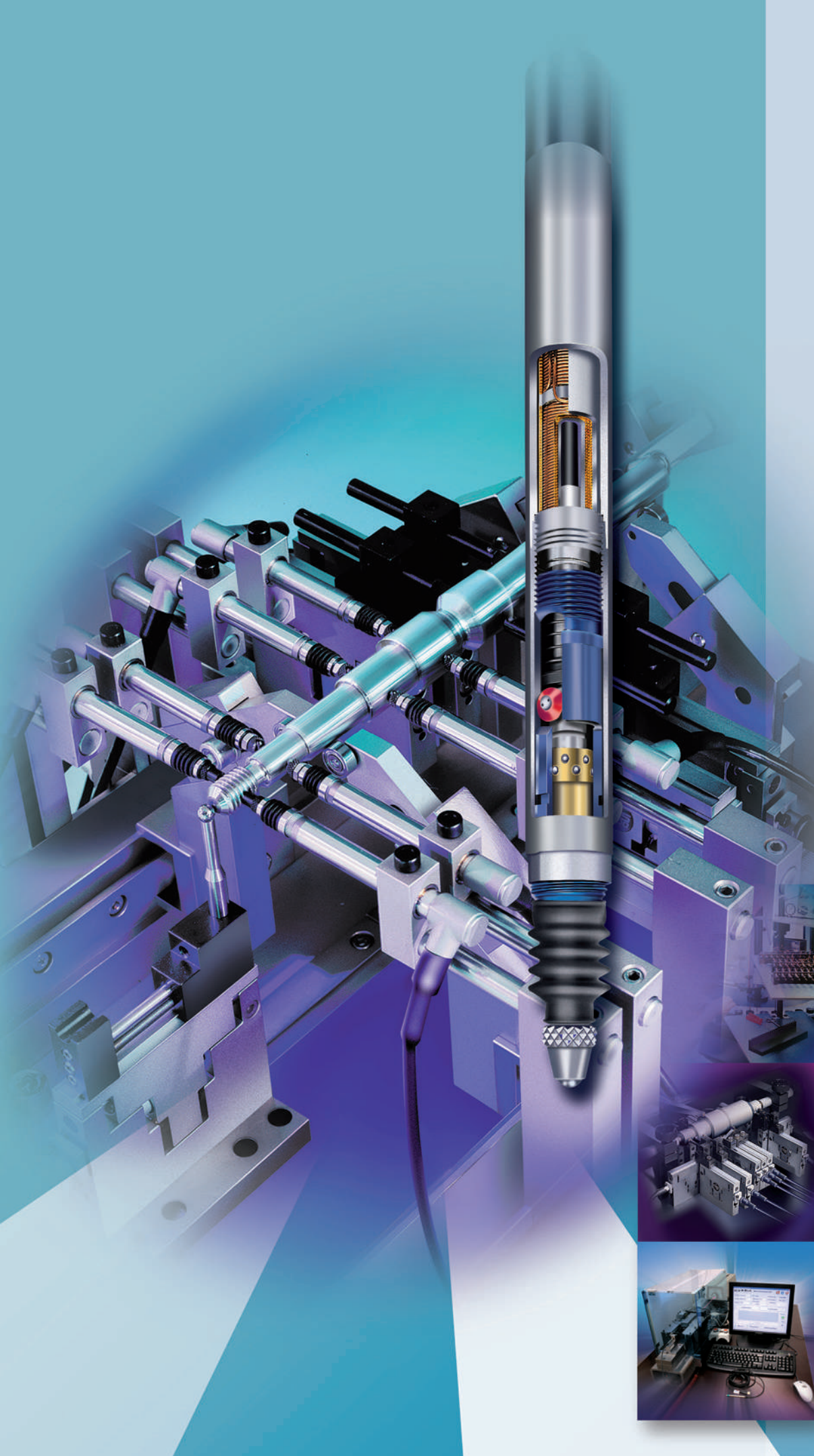

Electronic Length Measuring Equipment

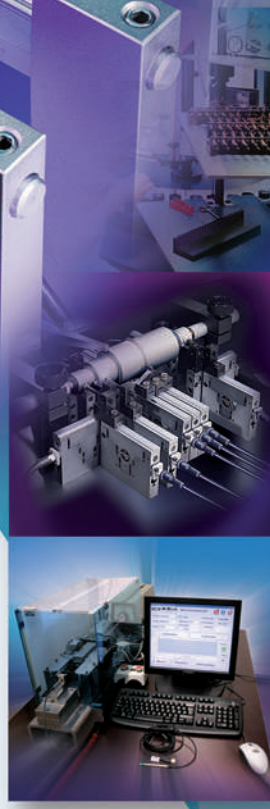

TESA INDUCTIVE PROBES AND ELECTRONIC EQUIPMENT

TESA probes: At the cutting edge of technology

TESA develops, manufactures and remains a leader in the inductive probe sector with an experience of more than 40 years. It offers a complete and unique line of probes designed to meet the requirements of varied as well as demanding applications.

Dimensional inspection of medium and large batches of parts in multigauging fixtures represents a major application area where measuring speed coupled with a high level of accuracy is needed.

High precision inductive probes (type GTL-21 HP) are, for example, also suited for the measurement of gauge blocks. The display resolution can reach a digital step of 0,01 μm !

On request, TESA probes can be supplied in versions compatible with the electronic equipment of other suppliers.

Typical qualities of TESA inductive probes : excellent repeatability, durability and longevity

All TESA inductive axial movement are mounted on a ball bearing with the exception of miniature models.

The ball bearing guidance system is insensitive to any radial force exerted on the probe housing. An anti-rotation guiding system ensures perfect movement of the mechanical guide.

The axial probe guide system is effectively protected against penetration of liquids (oils) or solids (dust) by sealing bellows of high elastic quality. Under normal conditions, the standard nitrile elastomer bellows provide sufficient protection against oils and solvents. For applications where the probes remain in prolonged contact with coolants or lubricants and aggressive chemicals, Viton bellows are recommended. Viton is a fluorelastomer resistant to the heat of oils and aggressive chemicals.

The retraction (lifting) of the measuring bolt rod can be made by the suction of air (vacuum) accumulated within the probe thanks to the airtightness provided by the sealing bellows. This method of working principle does not use any mechanical device ensures the operation of the guidance system in an optimal manner. Similarly, the probe can be moved into its measuring position by a pneumatic activation (pressure), depending on the probe model.

Inserts (measuring inserts) can be replaced or exchanged. A wide choice of geometrical forms and sizes are available

The measuring force can be adjusted by changing the spring, depending on the probe model.

The probes integrate an electronic amplifier of the signal without relying on any mechanical conversion device. Thus, these probes are distinguished by their high repeatability and very low hysteresis errors.

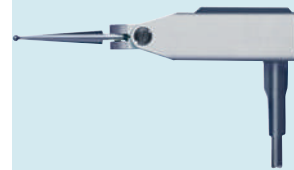
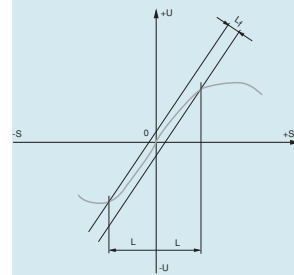

GT-31

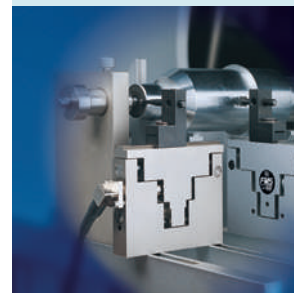

Probe FMS



TT20



USB probe



Wireless probe



Application examples of measuring functions

Measuring external dimensions with use of a measuring stand, snap gauge etc.

Single measurements with positive polarity sign (+A)

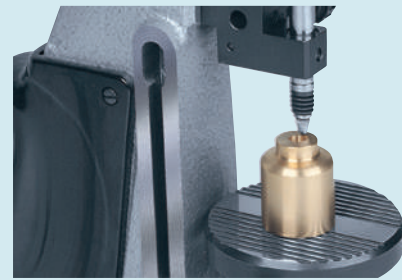
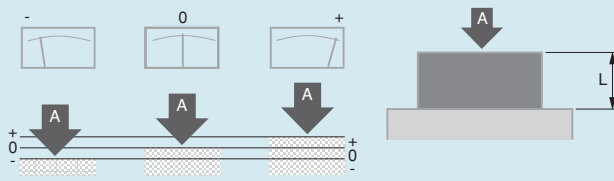

Inversion of polarity with displayed value equal to bore or diameter

Single measurements with negative polarity sign (-A)

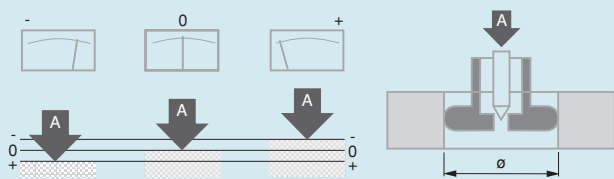

Measuring external dimensions regardless of form and position errors

Sum measurements with positive polarity signs (+A +B)

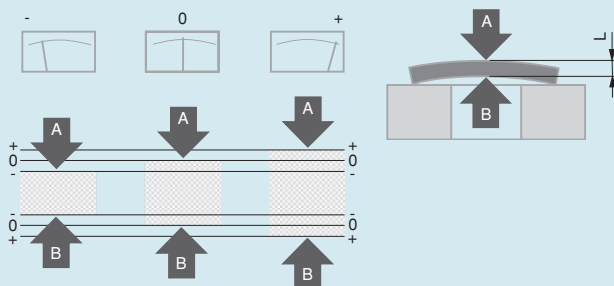

Cone, inclination and step measurements.

Difference measurements with opposite polarity signs (+A -B)

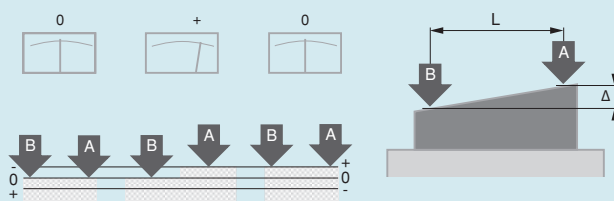

Establishing form and position errors with "max - min" memory function as in the example for runout errors

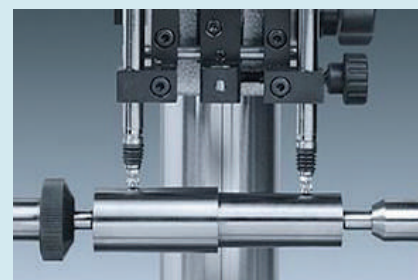
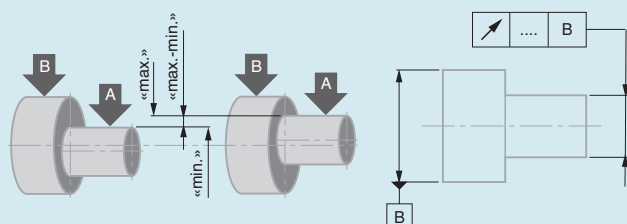

For the acquisition of measured values, TESA offers a complete family of probes and measuring instruments for the most demanding applications. The probes, supplied in standard execution, do not need any form of adaptation. They function on the inductive half-bridge principle.

The market offers other equipment using probes that partly operate on the principle of a differential transformer and these are known as LVDT (Linear Variable Differential Transformer) probes.

TESA also offers a range of probes compatible with other electronic equipment, using an adaptor and a connector depending on the origin of the equipment. A description of TESA standard half-bridge and LVDT probes is provided below.

Standard half-bridge probes for TESA equipment

OPERATING PRINCIPLE

All TESA electronic probes (value sensors) work based on the inductive principle with mechanical contact of the workpiece.

They are fitted with a coil system inducing an alternating output voltage that depends on the the position of the ferro magnetic core. When symmetrically positioned – i.e. at electrical zero – no voltage is impressed. A move of the core, which may be attached to the measuring bolt while the measurand is being taken, causes the inductance to change. This change generates a signal that is amplified and rectified before being displayed and further output. Depending on the instrument type, the analogue signal will be shown on a voltmeter or a numerical display after a digital transformation.

Unambiguous assessment of the measurand (at bolt position) to the signal (displayed value) is the main characteristic of analogue value acquisition. One of its distinct advantages lies in the value primarily displayed, which will be reproduced in the event of a power cut (switch-off or power failure).

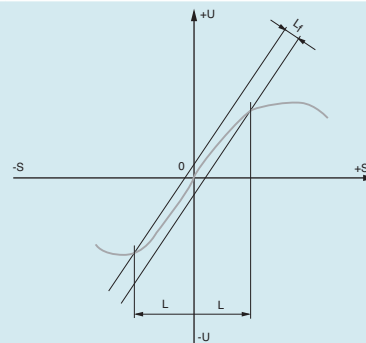

Inductive measuring
 S: Travel
 U: Output current
 0: Electrical zero
 L: Linearity range
 Lf: Linearity error

TESA Standard Half-Bridge Probes for TESA Electronic Equipment

These probes have two serial coils with middle output mounted side by side, which are energized by a sinusoidal alternation signal at 13 kHz. Both are linked together to a Wheatstone bridge over an additional half-bridge.

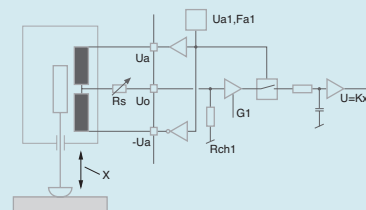

Wiring plan of half-bridge probes

TESA LVDT Probes

These probes are based on a Linear Variable Differential Transformer (LVDT). They have three coils, i.e. one primary coil being energized by a sinusoidal alternation at 5 kHz, and two secondary coils connected in opposite phase, which generate the output current proportional to the measuring travel.

Available upon request.

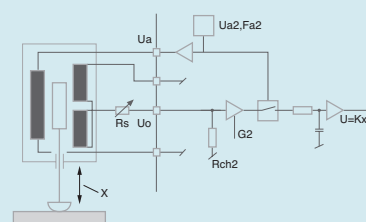

Wiring plan of LVDT probes



Multiple application possibilities

TESA probes have been designed for applications for use with instruments for internal and external measurements, measuring supports or special measuring systems. For such applications, different probe executions can be supplied such as probes with an axial measuring bolt or parallel guides, refer also to angle lever probes. In addition, there are also special executions developed for multi-gauging inspection fixtures or 'in-process' inspection stations, which enable an economy in the number of components needed. Apart from a few exceptions, the measuring operations executed are always comparative measurements with reference to a standard such as a gauge block, a setting ring or any other component that can be used as a master.

The measurements are extremely accurate. Bias error influence is negligible compared to the budget for measuring uncertainty given the fact that the comparison is being established between two almost practically equal values

Random errors also lose their influence in a procedure where the display setting is made under the same conditions as the subsequent probing measurements

TESA measuring instruments are equipped with an analogue and/or digital display, depending on the model.

Internal processing of measured values

Depending on the application, the electrical signals are processed in different ways within the instrument.

Mathematical Data Processing

The signals can be processed with positive polarity sign as well as negative polarity sign. The use of a single probe enables single measurement of internal or external dimensions while the combination of the signals of two probes produces either a "sum measurement" or a "difference measurement".

Value Storage

The storage of measured values in the memory ensures the reliability of dynamic measuring cycles. The characteristic values are the two minimum and maximum values or the difference between the smallest and largest value acquired while measuring form or position errors.

Classification of Values

The measured values can be classified after the entering of limit deviations. In this case, the control signals can be used by an external peripheral unit.

Components of a TESA inductive probe

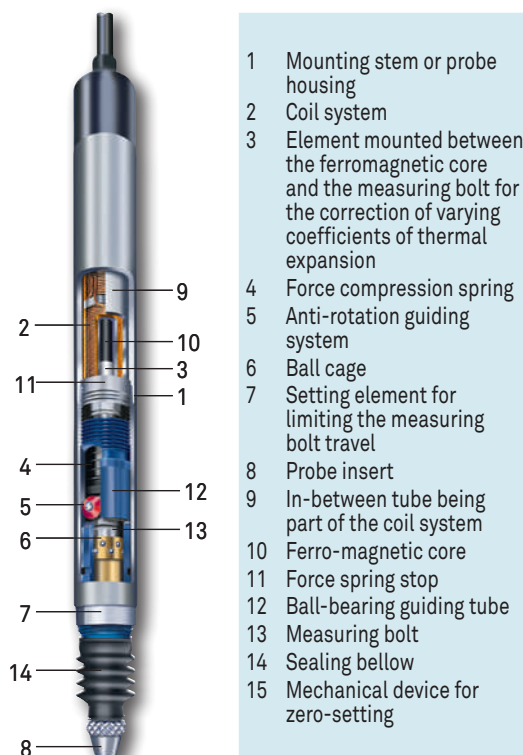

Sensitivity of TESA half-bridge probes for TESA electronic interfaces and electronic displays

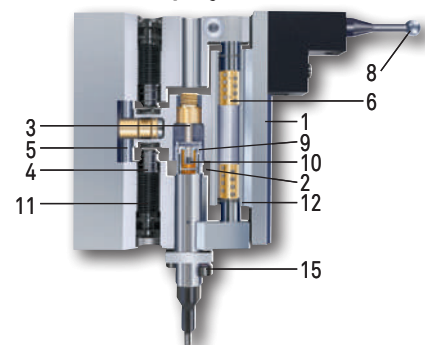

Sensitivity	73,75 mV/V/mm
	29,50 mV/V/mm (GT 61, GT 62)
	7,375 mV/V/mm (GT 61S, GT 62S)
	49,17 mV/V/mm (FMS 130, FMS 132)
All given values are valid for the following reference conditions :	
Drive voltage	3 V
Drive frequency	13 kHz
Adjustment load	2 k Ω











Probes with Axial Movement, Ø 8 mm

							
	No		Measuring range, mm	Measuring bolt travel, mm	Cable output	Measuring bolt retraction	Sealing bellows
	03210904	GT 21	± 1 mm	4,3	Axial	Mechanical	Nitrile
	03210924	GT 22	± 1 mm	4,3	Radial	Mechanical / vacuum	Nitrile
	03230057	GTL 21	± 2 mm	4,3	Axial	Mechanical	Viton
	03230072	GTL 211	± 2 mm	4,3	Axial	Mechanical / vacuum	Viton
	03230056	GTL 22	± 2 mm	4,3	Radial	Mechanical / vacuum	Viton
	03230027	GT 27	± 2 mm	10,3	Axial	Mechanical	Viton
	03230073	GT 271	± 2 mm	10,3	Axial	Mechanical / vacuum	Viton
	03230026	GT 28	± 2 mm	10,3	Radial	Mechanical / vacuum	Viton
	03230041	GT 61	± 5 mm	10,3	Axial	Mechanical	Viton
	03230042	GT 62	± 5 mm	10,3	Radial	Mechanical / vacuum	Viton
	03230036	GT 21 HP	± 0,2 mm	4,3	Axial	Mechanical	Nitrile
	03230021	GT 22 HP	± 0,2 mm	4,3	Radial	Mechanical / vacuum	Nitrile



* Nominal value of the measuring force at electrical zero, max. deviation $\pm 25\%$

** For an amplitude of 10 % to the last value of the measuring range

 Nominal measuring force*, N	 Mobile weight, g	 Mechanical limit max frequency** (Hz)	 Partially removable	 Répeatability, μm	 Max. permissible error for deviations in linearity, μm (L in mm)	 Hysteresis, μm	 Protection level (IP XX), as per IEC 60529
0,63	6	60	Yes	0,01 μm	$0,2 + 3 \cdot L^3 \mu\text{m}$	0,02	IP65
0,63	6	60	Yes	0,01 μm	$0,2 + 3 \cdot L^3 \mu\text{m}$	0,02	IP65
0,63	6	60	Yes	0,01 μm	$0,2 + 2,4 \cdot L^2 \mu\text{m}$	0,02	IP65
0,63	6	60	Yes	0,01 μm	BPX / TWIN-T10: $0,2 + 0,8 \cdot L \mu\text{m}$	0,02	IP65
0,63	6	60	Yes	0,01 μm	$0,2 + 2,4 \cdot L^2 \mu\text{m}$	0,02	IP65
0,63	6	60	Yes	0,01 μm	BPX / TWIN-T10: $0,2 + 0,8 \cdot L \mu\text{m}$	0,02	IP65
0,63	6	60	Yes	0,01 μm	$0,2 + 2,4 \cdot L^2 \mu\text{m}$	0,02	IP65
0,63	6	60	Yes	0,01 μm	BPX / TWIN-T10: $0,2 + 0,8 \cdot L \mu\text{m}$	0,02	IP65
0,63	8	60	Yes	0,05 μm	$0,2 + 3 \cdot L^3 \mu\text{m}$	0,05	IP65
0,63	8	60	Yes	0,05 μm	$0,2 + 3 \cdot L^3 \mu\text{m}$	0,05	IP65
0,63	8	60	Yes	0,05 μm	$0,2 + 3 \cdot L^3 \mu\text{m}$	0,05	IP65
0,90	8	60	Yes	0,05 μm	$1 + 4 \cdot L \mu\text{m}$	0,05	IP65
0,90	8	60	Yes	0,05 μm	BPX / TWIN-T10: $0,6 + 0,8 \cdot L \mu\text{m}$	0,05	IP65
0,90	8	60	Yes	0,05 μm	$1 + 4 \cdot L \mu\text{m}$	0,05	IP65
0,90	8	60	Yes	0,05 μm	BPX / TWIN-T10: $0,6 + 0,8 \cdot L \mu\text{m}$	0,05	IP65
0,63	6	60	No	0,01 μm	$0,07 + 0,4 \cdot L \mu\text{m}$	0,01	IP64
0,63	6	60	No	0,01 μm	$0,07 + 0,4 \cdot L \mu\text{m}$	0,01	IP64











Probes with Axial Movement, Ø 8 mm, with Activation of the Measuring Bolt by Pneumatic Pressure

						
			Measuring range, mm	Measuring bolt travel, mm	Cable output	Sealing bellows
	03230060	GTL 212	± 1,5 mm	3,2	Axial	Viton
	03230054	GTL 222	± 1,5 mm	3,2	Radial	Viton
	03230067	GTL 212-A	± 1,5 mm	3,2	Axial	Without bellows
	03230063	GTL 222-A	± 1,5 mm	3,2	Radial	Without bellows
	03230061	GT 272	± 2 mm	10,3	Axial	Viton
	03230053	GT 282	± 2 mm	10,3	Radial	Viton
	03230068	GT 272-A	± 2 mm	10,3	Axial	Without bellows
	03230069	GT 282-A	± 2 mm	10,3	Radial	Without bellows
	03230062	GT 612	± 5 mm	10,3	Axial	Viton
	03230055	GT 622	± 5 mm	10,3	Radial	Viton
	03230070	GT 612-A	± 5 mm	10,3	Axial	Without bellows
	03230071	GT 622-A	± 5 mm	10,3	Radial	Without bellows



* Nominal value of the measuring force at electrical zero, max. deviation $\pm 25\%$

** For an amplitude of 10 % to the last value of the measuring range

 Measuring force, nominal*, N	 Mobile weight, g	 Max. mechanical frequency limit** (Hz)	 Partially removable	 Repeatability, μm	 Max. permissible error for deviations in linearity, μm (L in mm)	 Hysteresis, μm	 Protection level (IP XX), as per IEC 60529
1,2	6	60	Yes	0,015 μm	0,2 + 2,4 · L ² μm BPX / TWIN-T10: 0,2 + 0,8 · L μm	0,02	IP65
1,2	6	60	Yes	0,015 μm	0,2 + 2,4 · L ² μm BPX / TWIN-T10: 0,2 + 0,8 · L μm	0,02	IP65
0,2	6	60	Yes	0,015 μm	0,2 + 2,4 · L ² μm BPX / TWIN-T10: 0,2 + 0,8 · L μm	0,02	IP50
0,2	6	60	Yes	0,015 μm	0,2 + 2,4 · L ² μm BPX / TWIN-T10: 0,2 + 0,8 · L μm	0,02	IP50
1,0	8	60	Yes	0,05 μm	0,2 + 3 · L ³ μm	0,05	IP65
1,0	8	60	Yes	0,05 μm	0,2 + 3 · L ³ μm	0,05	IP65
0,85	8	60	Yes	0,05 μm	0,2 + 3 · L ³ μm	0,05	IP50
0,85	8	60	Yes	0,05 μm	0,2 + 3 · L ³ μm	0,05	IP50
2,0	8	60	Yes	0,05 μm	1 + 4 · L μm BPX / TWIN-T10: 0,6 + 0,8 · L μm	0,05	IP65
2,0	8	60	Yes	0,05 μm	1 + 4 · L μm BPX / TWIN-T10: 0,6 + 0,8 · L μm	0,05	IP65
1,0	8	60	Yes	0,05 μm	1 + 4 · L μm BPX / TWIN-T10: 0,6 + 0,8 · L μm	0,05	IP50
1,0	8	60	Yes	0,05 μm	1 + 4 · L μm BPX / TWIN-T10: 0,6 + 0,8 · L μm	0,05	IP50











USB, DC, Wireless Probes

							
			Measuring range, mm	Max. plunger travel, mm	Cable output	Bolt retraction	Sealing bellows
	03230500	GTL 21 W	± 2 mm	4,3	Without cable	Mechanical	Viton
	03230502	GT61 W	± 5 mm	10,3	Without cable	Mechanical	Viton
	03230501	GTL 212 W	± 1,5 mm	4,3	Without cable	Pressure (bolt activation), bellows spring (bolt retraction)	Viton
	03230503	GT 612 W	± 5 mm	10,3	Without cable	Pressure (bolt activation), bellows spring (bolt retraction)	Viton
	03230201	GTL 22 USB	± 2 mm	4,3	Radial	Mechanical / vacuum	Viton
	03230200	GTL 21 USB	± 2 mm	4,3	Axial	Mechanical	Viton
	03230204	GT 61 USB	± 5 mm	10,3	Axial	Mechanical	Viton
	03230205	GT 62 USB	± 5 mm	10,3	Radial	Mechanical / vacuum	Viton
	03230202	GTL 222 USB	± 1,5 mm	3,1	Radial	Pressure (bolt activation), bellows spring (bolt retraction)	Viton
	03230058	GTL 22 DC	± 2 mm	4,3	Radial	Mechanical / vacuum	Viton
	03230059	GTL 21 DC	± 2 mm	4,3	Axial	Mechanical	Viton
	03230087	GT 62 DC	± 5 mm	10,3	Radial	Mechanical / vacuum	Viton
	03230086	GT 61 DC	± 5 mm	10,3	Axial	Mechanical	Viton
	03230085	GT 44 DC	± 1 mm	2,1	Radial	Mechanical / vacuum	Viton
	03230081	GT 31 DC	± 0,3 mm	0,7	Angled	Without retraction	Without bellows













* Nominal value of the measuring force at electrical zero, max. deviation $\pm 25\%$

** For an amplitude of 10% to the last value of the measuring range



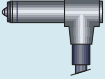

 Nominal measuring force*, N	 Mobile weight, g	 Max. mechanical frequency limit**, (Hz)	 Partially removable	 Repeatability, μm	 Maximum permissible error, μm (L in mm)	 Hysteresis, μm	 Level of protection (IP XX), as per IEC 60529
0,63	6	60	No	0,10 μm	$0,4 + 0,8 \cdot L \mu\text{m}$	0,5	IP54
0,9	8	60	No	0,24 μm	$0,8 + 0,8 \cdot L \mu\text{m}$	0,5	IP54
1,2	6	60	No	0,10 μm	$0,4 + 0,8 \cdot L \mu\text{m}$	0,5	IP54
2,0	8	60	No	0,24 μm	$0,8 + 0,8 \cdot L \mu\text{m}$	0,5	IP54
0,63	6	60	No	0,1 μm	$0,4 + 0,8 \cdot L \mu\text{m}$	0,5	IP65
0,63	6	60	No	0,1 μm	$0,4 + 0,8 \cdot L \mu\text{m}$	0,5	IP65
0,90	8	60	No	0,24 μm	$0,8 + 0,8 \cdot L \mu\text{m}$	0,5	IP65
0,90	8	60	No	0,24 μm	$0,8 + 0,8 \cdot L \mu\text{m}$	0,5	IP65
1,2	6	60	No	0,1 μm	$0,4 + 0,8 \cdot L \mu\text{m}$	0,5	IP64
0,63	6	60	Yes	0,1 μm	$0,2 + 3,5 \cdot L^2 \mu\text{m}$		IP65
0,63	6	60	Yes	0,1 μm	$0,2 + 3,5 \cdot L^2 \mu\text{m}$		IP65
0,9	8	60	No	0,1 μm	$1 + 4 \cdot L \mu\text{m}$		IP65
0,9	8	60	Yes	0,1 μm	$1 + 4 \cdot L \mu\text{m}$		IP65
0,4	2	60	No	0,1 μm	$0,2 + 5 \cdot L^2 \mu\text{m}$		IP65
0,1	12	25	No	0,1 μm	$0,2 + 50 \cdot L^2 \mu\text{m}$		IP50



Probes with Axial Movement, $\varnothing 8$ mm

							
			Measuring range, mm	Measuring bolt travel, mm	Cable output	Bolt retraction	Sealing bellows
	03230001	GT 41	$\pm 0,3$ mm	0,7	Axial	None	Nitrile
	03230002	GT 42	$\pm 0,3$ mm	0,7	Radial	Vacuum	Nitrile
	03230035	GT 43	± 1 mm	2,1	Axial	Mechanical	Viton
	03230017	GT 44	± 1 mm	2,1	Radial	Vacuum	Viton

Unbranded Axial Probes with Measuring Bolt Mounted on a Ball-bearing









	96410012	410	± 1 mm	2,5	Axial and radial	Mechanical	Nitrile
	96160013	160	± 1 mm	3,3	Axial	Mechanical	Viton
	96430029	430	$\pm 0,5$ mm	1,25	Axial	Mechanical	Nitrile
	96441041	451	$\pm 0,5$ mm	2,10	Radial	Mechanical	Nitrile

Probe with Inclinable Lever

	03210802	GT 31	$\pm 0,3$ mm	0,7	Angled	Without	Without bellows
---	----------	-------	--------------	-----	--------	---------	-----------------

* Nominal value of the measuring force at electrical zero, max. deviation $\pm 25\%$

** For an amplitude of 10 % to the last value of the measuring range

 Nominal measuring force*, N	 Mobile weight, g	 Max. mechanical frequency limit**, (Hz)	 Partially removable	 Repeatability, μm	 Max. permissible error for deviations in linearity, μm (L en mm)	 Hysteresis, μm	 Level of protection (IP XX), as per IEC 60529
0,63	2	60	No	0,01 μm	$0,2 + 5 \cdot L^2 \mu\text{m}$	0,01	IP65
0,63	2	60	No	0,01 μm	$0,2 + 5 \cdot L^2 \mu\text{m}$	0,01	IP65
0,4	2	60	No	0,1 μm	$0,2 + 5 \cdot L^2 \mu\text{m}$	0,15	IP65
0,4	2	60	No	0,1 μm	$0,2 + 5 \cdot L^2 \mu\text{m}$	0,15	IP65

0,60	3,1	60	No	0,1 μm	0,2 % (for a measuring span of ± 1 mm) μm		IP62
0,60	2,5	60	No	0,1 μm	0,2 % (for a measuring span of ± 1 mm) μm		IP62
0,75	1,9	60	No	0,2 μm	0,2 % (for a measuring span of $\pm 0,5$ mm) μm		IP62
0,60	3,0	60	No	0,1 μm	0,2 % (for a measuring span of $\pm 0,5$ mm) μm		IP62

0,1	12	25	No	0,1 μm	$0,2 + 50 \cdot L^2 \mu\text{m}$	0,25	IP40
-----	----	----	----	-------------------	----------------------------------	------	------











Universal FMS Probes

			 Measuring range, mm	 Measuring bolt travel, mm	 Cable output	 Bolt retraction	 Sealing bellows
	03230019	FMS 100	± 2 mm	5,8	Parallel	Retraction by air pressure (optional)	Without bellows
	03230049	FMS 130	± 2,9 mm	5,8	Parallel	Retraction by air pressure (optional)	Without bellows
	03230028	FMS 102	± 2 mm	5,8	Parallel	Retraction by air pressure (optional)	Without bellows
	03230050	FMS 132	± 2,9 mm	5,8	Parallel	Retraction by air pressure (optional)	Without bellows
	03230037	FMS100-P	± 2 mm	5,8	Parallel	Retraction by air pressure (optional)	Without bellows
	03230051	FMS130-P	± 2,9 mm	5,8	Parallel	Retraction by air pressure (optional)	Without bellows
	03230038	FMS102-P	± 2 mm	5,8	Angled	Retraction through air pressure (optional)	Without bellows
	03230052	FMS132-P	± 2,9 mm	5,8	Angled	Retraction through air pressure (optional)	Without bellows



* Nominal value of the measuring force at electrical zero, max. deviation $\pm 25\%$

** For an amplitude of 10% to the last value of the measuring range

 Nominal measuring force*, N	 Mobile weight, g	 Max. mechanical frequency limit**, Hz	 Partially removable	 Repeatability, μm	 Max. permissible error for deviation in linearity, μm (L in mm)	 Hysteresis, μm	 Protection level (IP XX), as per IEC 60529
2	110	25	Yes	0,5 μm	0,2 + 3 · L ³ μm	0,5	IP50
2	110	25	Yes	0,5 μm	0,2 + 3 · L ³ μm	0,5	IP50
2	110	25	Yes	0,5 μm	0,2 + 3 · L ³ μm	0,5	IP50
2	110	25	Yes	0,5 μm	0,2 + 3 · L ³ μm	0,5	IP50
2	110	25	Yes	0,5 μm	0,2 + 3 · L ³ μm	0,5	IP54
2	110	25	Yes	0,5 μm	0,2 + 3 · L ³ μm	0,5	IP54
2	110	25	Yes	0,5 μm	0,2 + 3 · L ³ μm	0,5	IP54
2	110	25	Yes	0,5 μm	0,2 + 3 · L ³ μm	0,5	IP54



Standard Probes, ± 1 mm, 4,3 mm Travel (GT21)

Universal probes for standard and continuous use applications.

- 8 mm diameter probe housing. Can be clamped over its entire length.
- Measuring bolt mounted on a ball bearing.
- Both the probe housing and ball-bearing guide are separate from one another, so that the measuring bolt moves easily even if the probe is not clamped appropriately.
- Degree of protection IP65 according to IEC 60529.
- Wide range of accessories including measuring inserts, spring sets, etc.
- LVDT probes compatible with measuring equipment from other makers available on request.



GT21

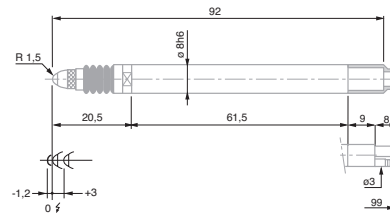

GT 21

		Measuring range, mm	Nominal measuring force*, N	Measuring bolt retraction	Sealing bellows
03210904	GT 21	± 1	0,63	Mechanical	Nitrile
03210905	GT 21	± 1	1,00	Mechanical	Nitrile
03210906	GT 21	± 1	1,60	Mechanical	Nitrile
03210907	GT 21	± 1	2,50	Mechanical	Nitrile
03210908	GT 21	± 1	4,00	Mechanical	Nitrile

Measuring bolt travel, mm	Max. permissible error for deviations in linearity, µm (L in mm)	Repeatability, µm	Hysteresis, µm	Setting of the lower bolt stop***, mm (factory setting)	Cable output	Data Sheet No.	
GT 21	4,3	0,2 + 3 · L ³	0,01	0,02	-2,2 to 0,1 (factory setting -1,2)	Axial	03200249

* Electrical zero (N) ± 25 % deviation limit. Valid in vertical mounting position, measuring bolt lowered and in static measuring.

** For an amplitude of 10 % to the last value of the measuring range.

*** Distance from electrical zero.

DIN 32876 Part 1

Nickel-plated housing. Stainless steel measuring bolt, hardened. Nitrile sealing bellows = resistant elastomer

Fixing shank Ø 8 mm. Measuring bolt guided on ball-bearing. Distance from electrical zero of both stops is either adjustable (downward) or depending on the position of the lower stop (upward). Interchangeable inserts. M2,5 thread. Carbide ball tip Ø 3 mm. 2 m long cable, 5-pin DIN 45322 connector.

Supply frequency: 13 kHz (± 5 %). Max mechanical frequency** 60 Hz.

0,15 µm/°C

20 ± 0,5°C

Protection level IP65 (IEC 60529)

Mobile weight: 6 g

Inspection report with a declaration of conformity



N DIN 32876
Part 1

B Nickel-plated housing. Stainless steel measuring bolt, hardened. Nitrile sealing bellows = resistant elastomer

A Fixing shank Ø 8 mm. Measuring bolt guided on ball-bearing. Distance from electrical zero of both stops is either adjustable (downward) or depending on the position of the lower stop (upward). Interchangeable inserts. M2,5 thread. Carbide ball tip Ø 3 mm. 2 m long cable. 5-pin DIN 45322 connector.

⚡ Supply frequency: 13 kHz (± 5 %). Max mechanical frequency** 60 Hz.

👉 0,15 µm/°C

👉 20 ± 0,5°C

🛡️ Protection level IP65 (IEC 60529)

📦 Mobile weight: 6 g

📄 Inspection report with a declaration of conformity

Standard Probes, ± 1 mm, 4,3 mm Travel (GT22)

Universal probes for common but constraining applications.

- 8 mm diameter probe housing. Can be clamped over its entire length.
- Measuring bolt mounted on a ball bearing.
- Both the probe housing and ball-bearing guide are separate from one another, so that the measuring bolt moves easily even if the probe is not clamped appropriately.
- Degree of protection IP65 according to IEC 60529.
- Wide range of accessories including measuring inserts, spring sets, etc.
- LVDT probes compatible with measuring equipment from other makers available on request.



GT 22

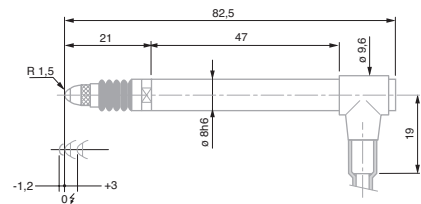

GT 22

No	=	 	👉	⚡	🛡️
		Measuring range, mm	Nominal measuring force*, N	Measuring bolt retraction	Sealing bellows
03210924	GT 22	± 1	0,63	Mechanical / vacuum	Nitrile
03210921	GT 22	± 1	0,16	Mechanical / vacuum	Nitrile
03210922	GT 22	± 1	0,25	Mechanical / vacuum	Nitrile
03210923	GT 22	± 1	0,40	Mechanical / vacuum	Nitrile
03210925	GT 22	± 1	1,00	Mechanical	Nitrile
03210926	GT 22	± 1	1,60	Mechanical	Nitrile
03210927	GT 22	± 1	2,50	Mechanical	Nitrile
03210928	GT 22	± 1	4,00	Mechanical	Nitrile

=	 	0±	↕	⌚	A	⚡	⚠️
Measuring travel, mm	Max. permissible error for deviations in linearity, µm (L in mm)	Repeatability, µm	Hysteresis, µm	Setting of the lower bolt stop***, mm (factory setting)	Cable output	Data Sheet No.	
GT 22	4,3	0,2 + 3 · L ³	0,01	0,02	-2,2 to 0,1 (factory setting -1,2)	Radial	03200250

* Electrical zero (N) ± 25 % deviation limit. Valid in vertical mounting position, measuring bolt lowered and in static measuring.

** For an amplitude of 10 % to the last value of the measuring range.

*** Distance from electrical zero.



Standard Probes ± 2 mm, 4,3mm Bolt Travel, Linear Travel

Universal probes for standard and continual usage applications.

- Probe housing Ø 8 mm with possibility of clamping over its entire length.
- Measuring bolt mounted on a ball bearing.
- Both the probe housing and ball-bearing guide are separate from one another, so that the measuring bolt moves easily even if the probe is not clamped appropriately.
- Degree of protection IP65 according to IEC 60529.
- Wide range of accessories including measuring inserts, spring sets, etc.
- LVDT probes compatible with measuring equipment from other makers available on request.

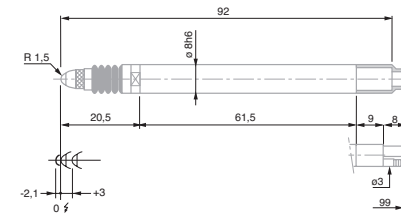

GTL 21
GTL 211

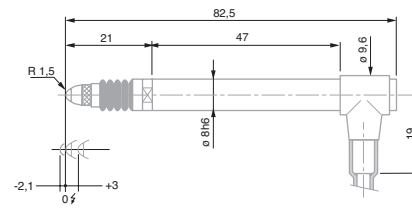

GTL 22



GTL 21
GTL 211



GTL 22

No		Measuring range, mm	Nominal measuring force*, N	Measuring bolt retraction	Sealing bellows
03230057	GTL 21	± 2	0,63	Mechanical	Viton
03230072	GTL 211	± 2	0,63	Mechanical / vacuum	Viton
03230056	GTL 22	± 2	0,63	Mechanical / vacuum	Viton

	Measuring bolt travel, mm	Max. permissible error for deviation in linearity, µm (L in mm)	Repeatability, µm	Hysteresis, µm	Setting of measuring bolt lower stop***, mm (factory setting)	Cable output	Data Sheet No.
GTL 21	4,3	0,2 + 2,4 · L ² (BPX: 0,2 + 0,8 · L)	0,01	0,02	-2,2 to 0,1 (factory setting -2,1)	Axial	03200391
GTL 211	4,3	0,2 + 2,4 · L ² (BPX: 0,2 + 0,8 · L)	0,01	0,02	-2,2 to 0,1 (factory setting -2,1)	Axial	03200435
GTL 22	4,3	0,2 + 2,4 · L ² (BPX: 0,2 + 0,8 · L)	0,01	0,02	-2,2 to 0,1 (factory setting -2,1)	Radial	03200392

* Electrical zero (N) ± 25 % deviation limit. Valid in vertical mounting position, measuring bolt lowered and in static measuring.

** For an amplitude of 10 % to the last value of the measuring range.

*** Distance from electrical zero.

- N** DIN 32876 Part 1
- N** Nickel-plated housing. Stainless steel measuring bolt, hardened. Viton sealing bellows = highly resistant fluoroelelastometer
- A** Fixing shank Ø 8 mm. Measuring bolt guided on ball-bearing. Distance from electrical zero of both stops is either adjustable (downward) or depending on the position of the lower stop (upward). Interchangeable inserts. M2,5 thread. Carbide ball tip Ø 3 mm. 2 m long cable. 5-pin DIN 45322 connector.
- N** Supply frequency: 13 kHz (± 5 %) Max. mechanical frequency** 60 Hz.
- N** 0,2 µm/°C
- N** 20 ± 0,5°C
- N** Protection level IP65 (IEC 60529)
- N** Mobile weight: 6 g
- N** Inspection report with a declaration of conformity



N DIN 32876 Part 1

⚙️ Nickel-plated housing. Stainless steel measuring bolt, hardened. Viton bellows = high-resistance fluoroelastomer

A Fixing shank Ø 8 mm. Measuring bolt guided on ball-bearing. Distance from electrical zero of both stops is either adjustable (downward) or depending on the position of the lower stop (upward). Interchangeable inserts. M2,5 thread. Carbide ball tip Ø 3 mm. 2 m long cable. 5-pin DIN 45322 connector.

⚙️ Supply frequency: 13 kHz (± 5 %) Max. mechanical frequency** 60 Hz.

🌡️ 0,15 µm/°C

👉 20 ± 0,5°C

🛡️ Protection level IP65 (IEC 60529)

📏 Mobile weight: 8 g

📄 Inspection report with a declaration of conformity

Standard Probes, ± 2 mm, 10,3 mm Travel, with Long Retraction Travel

Universal inductive probes for various applications, especially for use with multi-gauging inspection fixtures.

- Long retraction travel to prevent the probe from being damaged.
- Protection level IP65 as per IEC 60529.
- Large choice of accessories: measuring inserts, spring sets, etc.
- LVDT probes compatible with measuring equipment from other suppliers also available on request.



GT 27



GT 271



GT 28

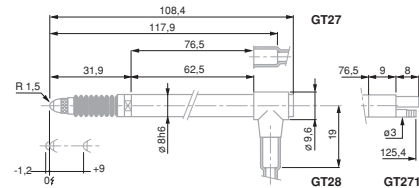

GT 27/ 28
GT 271

No	=	 	👉	⚙️	⚙️
		Measuring range, mm	Nominal measuring force*, N	Measuring bolt retraction	Sealing bellows
03230027	GT 27	± 2	0,63	Mechanical	Viton
03230073	GT 271	± 2	0,63	Mechanical / vacuum	Viton
03230026	GT 28	± 2	0,63	Mechanical / vacuum	Viton

=	 	↕	↔	↔	A	⚙️	⚠️
Measuring bolt travel, mm	Max. permissible error for deviations in linearity, µm (L in mm)	Repeatability, µm	Hysteresis, µm	Setting of measuring bolt lower stop***, mm (factory setting)	Cable output	Data Sheet No.	
GT 27	10,3	0,2 + 3 · L ³	0,05	0,05	-2,2 to 0,1 (factory setting -1,2)	Axial	03200251
GT 271	10,3	0,2 + 3 · L ³	0,05	0,05	-2,2 to 0,1 (factory setting -1,2)	Axial	03200436
GT 28	10,3	0,2 + 3 · L ³	0,05	0,05	-2,2 to 0,1 (factory setting -1,2)	Radial	03200252

* Electrical zero (N) ± 25 % deviation limit. Valid in vertical mounting position, measuring bolt lowered and in static measuring.

** For an amplitude of 10 % to the last value of the measuring range.

*** Distance from electrical zero



Standard Probes ± 5 mm, 10,3 mm Bolt Travel, Extended Range

- Designed for long measuring travels and low resolution of values
- Specially suited for use on multigauging inspection fixtures.
- Correction factor applied to get the true value is 2,5x (10x for the S probe version).
- Protection level IP 65 as per IEC 60529.
- Large choice of accessories: Measuring inserts, spring sets, etc.
- LVDT probes compatible with measuring equipment from other suppliers also available on request.



GT 61



GT 62

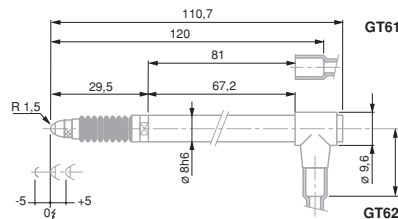

GT 61 / GT 62

- N** DIN 32876 Part 1
- S** Nickel-plated housing. Stainless steel measuring bolt, hardened. Viton bellows = highly resistant fluoroe-lastomer
- A** Fixing shank Ø 8 mm. Measuring bolt guided on ball-bearing. Distance from electrical zero of both stops is either adjustable (downward) or depending on the position of the lower stop (upward). Interchangeable inserts. M2,5 thread. Carbide ball tip Ø 3 mm. 2 m long cable. 5-pin DIN 45322 connector.
- S** Supply frequency: 13 kHz (± 5 %) Max. mechanical frequency** 60 Hz.
- T** 0,09 µm/°C
- H** 20 ± 0,5°C
- J** Protection level IP65 (IEC 60529)
- M** Mobile weight: 8 g
- R** Inspection report with a declaration of conformity

	No	=	 	✋	✳	✳
			Measuring range, mm	Nominal measuring force*, N	Measuring bolt retraction	Sealing bellows
03230041	GT 61	± 5	0,90	Mechanical	Viton	
03230042	GT 62	± 5	0,90	Mechanical / vacuum	Viton	

	=	 	0	↕	↔	A	✳	⚠
	Measuring bolt travel, mm	Max. permissible error for deviations in linearity, µm (L in mm)	Repeatability, µm	Hysteresis, µm	Measuring bolt***, mm (factory setting)	Cable output	Data Sheet No.	
GT 61	10,3	1 + 4 · L (BPX: 0,2 + 0,8 · L)	0,05	0,05	Lower - 5,1 upper + 5,2 (factory setting -5)	Axial	03200294	
GT 62	10,3	1 + 4 · L (BPX: 0,2 + 0,8 · L)	0,05	0,05	Lower - 5,1 upper + 5,2 (factory setting -5)	Radial	03200295	

* Electrical zero (N) ± 25 % deviation limit. Valid in vertical mounting position, measuring bolt lowered and in static measuring.
 ** For an amplitude of 10 % to the last value of the measuring range.
 *** Distance from electrical zero.



GT 21 HP High Precision Probes, ± 0,2 mm, 4,3 mm Travel

N DIN 32876 Part 1

N Nickel-plated housing. Stainless steel measuring bolt, hardened. Nitrile sealing bellow = resistant elastomer

A Fixing shank Ø 8 mm. Measuring bolt guided on ball-bearing. Distance from electrical zero of both stops is either adjustable (downward) or depending on the position of the lower stop (upward). Interchangeable inserts. M2,5 thread. Carbide ball tip Ø 3 mm. 2 m long cable. 5-pin DIN 45322 connector.

N Supply frequency: 13 kHz (± 5 %) Max. mechanical frequency** 60 Hz.

N 0,15 µm/°C

N 20 ± 0,5°C

N Protection level IP65 (IEC 60529)

N Mobile weight: 6 g

N Inspection report with a declaration of conformity

- Universal probe for common and continuous use applications.
- Very high precision probe suited for the measurement of gauge blocks.
- 8 mm diameter probe housing. Can be clamped over its entire length.
- Measuring bolt mounted on a ball bearing.
- Both the probe housing and ball-bearing guide are separate from one another, so that the measuring bolt moves easily even if the probe is not clamped appropriately.
- Level of protection IP65 according to IEC 60529.
- Wide range of accessories including measuring inserts, spring sets, etc.
- LVDT probes compatible with measuring equipment from other makers available on request.



GT 21 HP

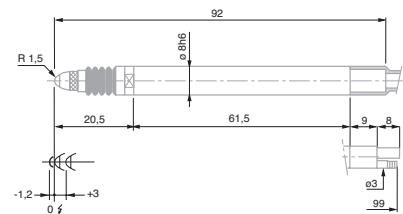

GT 21 HP

No	=	N	N	N	N
		Measuring range, mm	Measuring force, nominal*, N	Bolt retraction	Sealing bellows
03230036	GT 21 HP	± 0,2	0,63	Mechanical	Nitrile

=	N	0	N	N	A	N	N
Measuring bolt travel, mm	Max. permissible error for deviations in linearity, µm (L in mm)	Repeatability, µm	Hysteresis, µm	Setting of lower stop of measuring bolt***, mm (factory setting)	Cable output	Data Sheet No.	
GT 21 HP 4,3	07 + 0,4 · L	0,01	0,01	-2,2 to +0,1 (factory setting -1,2)	Axial	03200264	

* Electrical zero (N) ± 25 % deviation limit. Valid in vertical mounting position, measuring bolt lowered and in static measuring.
 ** For an amplitude of 10 % to the last value of the measuring range.
 *** Distance from electrical zero.



GT 22 HP High Precision Probe, ± 0,2 mm, 4,3 mm Travel

Universal probe for standard and continuous use applications.

- Very high precision probe suitable for the measurement of gauge blocks.
- 8 mm diameter probe housing. Can be clamped over its entire length.
- Measuring bolt mounted on a ball bearing.
- Both the probe housing and ball-bearing guide are separate from one another, so that the measuring bolt moves easily even if the probe is not clamped appropriately.
- Level of protection IP65 according to IEC 60529.
- Wide range of accessories including measuring inserts, spring sets, etc.
- LVDT probes compatible with measuring equipment from other makers available on request.



GT 22 HP

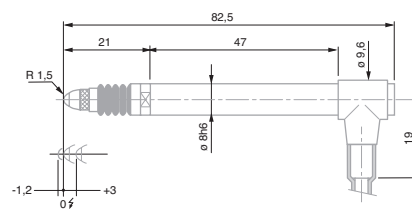

GT 22 HP

03230021	GT 22 HP	± 0,2	0,63	Mechanical / vacuum	Nitrile
		Measuring range, mm	Measuring force, nominal*, N	Bolt retraction	Sealing bellows

GT 22 HP	4,3	0,07 + 0,4 · L	0,01	0,01	-2,2 to +0,1 (usine -1,2)	Radial	03200265
	Measuring travel, mm	Max. permissible error for deviations in linearity, µm (L in mm)	Repeatability, µm	Hysteresis, µm	Setting of lower stop of the measuring bolt***, mm (factory setting)	Cable output	Data Sheet No.

* Electrical zero (N) ± 25 % deviation limit. Valid in vertical mounting position, measuring bolt lowered and in static measuring.

** For an amplitude of 10 % to the last value of the measuring range.

*** Distance from electrical zero.

DIN 32876 Part 1

Nickel-plated housing. Stainless steel measuring bolt, hardened. Nitrile sealing bellows = resistant elastomer

Fixing shank Ø 8 mm. Measuring bolt guided on ball-bearing. Distance from electrical zero of both stops is either adjustable (downward) or depending on the position of the lower stop (upward). Interchangeable inserts. M2,5 thread. Carbide ball tip Ø 3 mm. 2 m long cable. 5-pin DIN 45322 connector.

Supply frequency: 13 kHz (± 5 %) Max. mechanical frequency*** 60 Hz.

0,15 µm/°C

20 ± 0,5°C

Protection level IP65 (IEC 60529)

Mobile weight: 6 g

Inspection report with a declaration of conformity

Pneumatic Probes ± 1,5 mm, 3,2 mm Bolt Travel, Linear

N DIN 32876 Part 1

Nickel-plated housing, Stainless steel measuring bolt, hardened. Viton sealing bellows = highly resistant fluoroelastomer

A Fixing shank Ø 8 mm. Measuring bolt guided on ball-bearing. Distance from electrical zero of both stops is either adjustable (downward) or depending on the position of the lower stop (upward). Interchangeable inserts. M2,5 thread. Carbide ball tip Ø 3 mm. 2 m long cable. 5-pin DIN 45322 connector.

Supply frequency: 13 kHz (± 5 %) Max. mechanical frequency** 60 Hz.

0,2 µm/°C

20 ± 0,5°C

Protection level: IP65 (IEC 60529) or IP50 for GTL 212-A and GTL 222-A

Mobile weight: 6 g

Inspection report with a declaration of conformity

Probes for use with measuring fixtures or inspection machines integrating semi-automated or automated measuring routines.

- 8 mm diameter probe housing. Can be clamped over its entire length.
- Measuring bolt mounted on a ball bearing.
- Both the probe housing and ball-bearing guide are separate from one another, so that the measuring bolt moves easily even if the probe is not clamped appropriately.
- Degree of protection IP65 according to IEC 60529.
- Wide range of accessories including measuring inserts, etc.
- LVDT probes compatible with measuring equipment from other makers available on request.

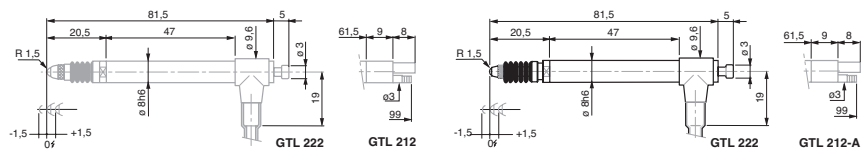

GTL 212 / GTL 222

GTL 212-A / GTL 222-A



GTL 222

GTL 212

GTL 212-A

GTL 222-A

No	Measuring bolt travel, mm	Measuring range, mm	Measuring force, nominal*, N	Measuring bolt retraction	Sealing bellows	Nominal/Maximal pressure, bar
03230060	GTL 212	± 1,5	1,2	Pressure (bolt activation), spring (bolt retraction)	Viton	0,7 / max 1,0
03230054	GTL 222	± 1,5	1,2	Pressure (bolt activation), spring (bolt retraction)	Viton	0,7 / max 1,0
03230067	GTL 212-A	± 1,5	0,2	Pressure (bolt activation), spring (bolt retraction)	Without bellows	0,25 / max 6,0
03230063	GT 222-A	± 1,5	0,2	Pressure (bolt activation), spring (bolt retraction)	Without bellows	0,25 / max 6,0

	Measuring bolt travel, mm	Max. permissible error for deviations in linearity, µm (L in mm)	Repeatability, µm	Hysteresis, µm	Cable output	Data Sheet No.
GTL 212	3,2	0,2 + 2,4 · L ² (BPX: 0,2 + 0,8 · L)	0,015	0,02	Axial	03200413
GTL 222	3,2	0,2 + 2,4 · L ² (BPX: 0,2 + 0,8 · L)	0,015	0,02	Radial	03200393
GTL 212-A	3,2	0,2 + 2,4 · L ² (BPX: 0,2 + 0,8 · L)	0,015	0,02	Axial	03200430
GT 222-A	3,2	0,2 + 2,4 · L ² (BPX: 0,2 + 0,8 · L)	0,015	0,02	Radial	03200422

* Electrical zero (N) ± 25 % deviation limit. Valid in vertical mounting position, measuring bolt lowered and in static measuring.

** For an amplitude of 10 % to the last value of the measuring range.



Pneumatic Probes ± 2 mm, 10,3 mm Bolt Travel, with Long Retraction Travel

These probes are intended for use with measuring fixtures or machines integrating automated and semi-automated measuring routines.

- 8 mm diameter probe housing. Can be clamped over its entire length.
- Measuring bolt mounted on a ball bearing.
- Both the probe housing and ball-bearing guide are separate from one another, so that the measuring bolt moves easily even if the probe is not clamped appropriately.
- Degree of protection IP65 according to IEC 60529.
- Wide range of accessories including measuring inserts, etc.
- LVDT probes compatible with measuring equipment from other makers available on request.



GT 282-A

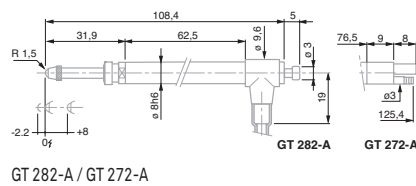

GT 282-A / GT 272-A

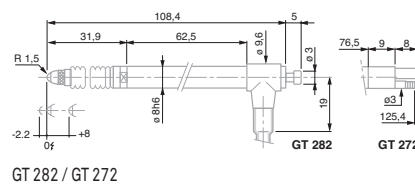

GT 282 / GT 272



GT 282



GT 272



GT 272-A

		Measuring range, mm	Measuring force, nominal*, N	Bolt retraction	Sealing bellows	Nominal/Maximal pressure, bar
03230061	GT 272	± 2	1,0	Pressure (bolt activation), spring (bolt retraction)	Viton	1,1 / max 1,5
03230053	GT 282	± 2	1,0	Pressure (bolt activation), spring (bolt retraction)	Viton	1,1 / max 1,5
03230068	GT 272-A	± 2	0,85	Pressure (bolt activation), spring (bolt retraction)	Without bellows	1,0 / max 6,0
03230069	GT 282-A	± 2	0,85	Pressure (bolt activation), spring (bolt retraction)	Without bellows	1,0 / max 6,0

	Measuring bolt travel, mm	Max. permissible error for deviations in linearity, µm (L in mm)	Repeatability, µm	Hysteresis, µm	Cable output	Data Sheet No.
GT 272	10,3	0,2 + 3 · L ³	0,05	0,05	Axial	03200414
GT 282	10,3	0,2 + 3 · L ³	0,05	0,05	Radial	03200390
GT 272-A	10,3	0,2 + 3 · L ³	0,05	0,05	Axial	03200431
GT 282-A	10,3	0,2 + 3 · L ³	0,05	0,05	Radial	03200432

* Electrical zero (N) ± 25 % deviation limit. Valid in vertical mounting position, measuring bolt lowered and in static measuring.

** For an amplitude of 10 % to the last value of the measuring range.

- DIN 32876 Part 1
- Nickel-plated housing. Stainless steel measuring bolt, hardened. Viton sealing bellows = highly resistant fluoroelastomer
- Fixing shank Ø 8 mm. Measuring bolt guided on ball-bearing. Distance from electrical zero of both stops is either adjustable (downward) or depending on the position of the lower stop (upward). Interchangeable inserts. M2,5 thread. Carbide ball tip Ø 3 mm. 2 m long cable. 5-pin DIN 45322 connector.
- Supply frequency: 13 kHz (± 5 %) Max. mechanical frequency** 60 Hz.
- 0,15 µm/°C
- 20 ± 0,5°C
- Protection level: IP65 (IEC 60529), IP64 for GT 21 HP
- Mobile weight: 8 g
- Inspection report with a declaration of conformity



Wireless Probe ± 2 mm

Probes developed for devices requiring a greater freedom of movement during the measurement or for parts with large dimensions.

Bidirectional and wireless communication synchronized with the TWIN-STATION Receiver.

- Resolution 0,1 μ m.
- Range of 8 m, depending on environment.
- TESA wireless communication protocol independent of WiFi or Bluetooth.
- Autonomy 40 hours (rechargeable battery).
- Mounting stem \varnothing 8 mm with clamping possible over entire length.
- Measuring bolt mounted on ball bearing.
- Ball bearing guide separated from mounting stem in order not to negatively influence the movement of the measuring bolt in the event of improper clamping of the probe body.
- Level of protection IP54 according to IEC 60529.
- Wide range of measurement inserts.
- The TWIN-STATION (part number 05030012) manages and synchronizes up to 8 wireless probes.
- Interface Software TIS included in delivery content of the TWIN-STATION (part number 05030012): display of measured values, possibility to indicate tolerances, simple functions +A, -A, +A+B, +A-B, and export of values as a .csv file.

Note: The sales is limited to EU countries, Switzerland, USA, Canada and China.



GTL 21 W

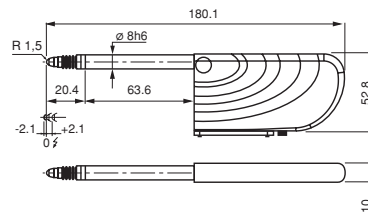

GTL 21 W

		Measuring range, mm	Nominal measuring force*, N	Bolt retraction	Sealing bellows
03230500	GTL 21 W	± 2	0,63	Mechanical	Viton
OPTIONAL ACCESSORY:					
05030012	TWIN-STATION Interface for wireless probes				

	Max. plunger travel, mm	Maximum permissible error, μ m (L in mm)	Repeatability, μ m	Hysteresis, μ m	Setting of lower stop of the measuring bolt***, mm	Cable output	Data sheet No.
GTL 21 W	4,3	0,4 + 0,8 · L	0,10	0,5	Fixed stops: lower -2,1 upper +2,1	Without cable	03200602

* Electrical zero (N) ± 25 % deviation limit. Valid in vertical mounting position, measuring bolt lowered and in static measuring.
 ** For an amplitude of 10 % to the last value of the measuring range.
 *** Distance from electrical zero.

- DIN 32876 Part 1
- Nickel-plated housing
Stainless steel measuring bolt, hardened
Viton sealing bellows = highly resistant fluoroe-lastomer
- Fixing body nickel \varnothing 8 mm
Stainless steel measuring bolt, hardened and ball bearing guided
Fixed upper and lower stops
Interchangeable inserts
M2,5 thread
Carbide ball \varnothing 3 mm
Mini jack connector for charger.
- Mechanical max. frequency**: 60 Hz
Power supply: 100 \div 240 VAC, 50 \div 60 Hz; 240 mAh Rechargeable battery; 3,7 V, min. 550 mAh or 800 mAh
Frequency band: 2,4 GHz Range: 8 m, depending on environment.
- Wireless transmission, TWIN-STATION Receiver (05030012)
- $\pm 0,2$ μ m/ $^{\circ}$ C
- $20 \pm 0,5$ $^{\circ}$ C
- Protection level IP54 (IEC 60529)
- GTL 21 W: 6g
- Inspection report with a declaration of conformity



Wireless Probe ± 5 mm, Large Measuring Range

Probes developed for devices requiring a greater freedom of movement during the measurement or for parts with large dimensions.

Bidirectional and wireless communication synchronized with the TWIN-STATION Receiver.

- Resolution 0,1 µm.
- Range of 8 m, depending on environment.
- TESA wireless communication protocol independent from WiFi or Bluetooth.
- Autonomy 40 hours (rechargeable battery).
- Mounting body Ø 8 mm with possibility of clamping over entire length.
- Measuring bolt mounted on ball bearing.
- Separate guide bearing on the mounting body in order not to negatively influence the movement of the measuring bolt in the event of improper clamping on the probe body.
- Level of protection IP54 according to IEC 60529.
- Wide range of measurement probes.
- The TWIN-STATION (part number 05030012) manages and synchronizes up to 8 wireless probes.
- Interface Software TIS included in supply content of the TWIN-STATION (part number 05030012): display of measured values, possibility to indicate tolerances, simple functions +A, -A, +A+B, +A-B, and export of values in a .csv file.

Note: The sales is limited to EU countries, Switzerland, USA, Canada and China.

N DIN 32876 Part 1

☆ Nickel-plated housing
Stainless steel measuring bolt, hardened. Viton = highly resistant fluoroelastomer

A Fixing shank Ø 8 mm. Measuring bolt guided on ball-bearing. Distance from electrical zero of both stops is either adjustable (downward) or depending on the position of the lower stop (upward). Interchangeable inserts. M2,5 thread. Carbide ball tip Ø 3 mm. Connector Mini-jack for charger.

☆ Mechanical max. frequency** : 60 Hz
Power supply: 100 ÷ 240 VAC, 50 ÷ 60 Hz; 240 mAh
Rechargeable battery: 3,7 V, min. 550 mAh or 800 mAh
Frequency band: 2,4 GHz
Range: 8 m, depending on environment.

📶 Wireless transmission, TWIN-STATION Receiver (05030012)

📏 ± 0,2 µm/°C

👤 20 ± 0,5°C

🛡️ Protection operating envelope IP54 (IEC 60529)

⚖️ GT 61 W: 8 g

📄 Inspection report with a declaration of conformity



GT 61 W

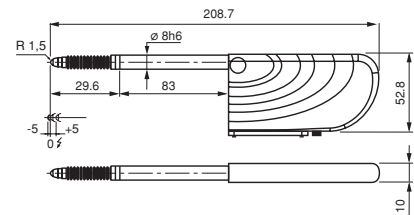

GT 61 W

No	=	📏	👤	☆	☆
		Measuring range, mm	Nominal measuring force*, N	Bolt retraction	Sealing bellows
03230502	GT 61 W	± 5	0,9	Mechanical	Viton
OPTIONAL ACCESSORY:					
05030012	TWIN-STATION Interface for wireless probes				

=	📏	0	↕	↔	A	☆	⚠️
	Max. bolt travel, mm	Maximum permissible error, µm (L in mm)	Repeatability, µm	Hysteresis, µm	Setting of lower stop of measuring bolt***, mm	Cable output	Data sheet No.
GT 61 W	10,3	0,8 + 0,8 · L	0,24	0,5	Fixed stops lower -5 upper +5	Without cable	03200621

* Electrical zero (N) ± 25 % deviation limit. Valid in vertical mounting position, measuring bolt lowered and in static measuring.

** For an amplitude of 10 % to the last value of the measuring range.

*** Distance from electrical zero.



Wireless Pneumatic Probe $\pm 1,5$ mm

Probes developed for devices requiring a greater freedom of movement during the measurement or for parts with large dimensions.

Bidirectional and wireless communication synchronized with the TWIN-STATION Receiver.

- Resolution 0,1 μ m.
- Range of 8 m, depending on environment.
- TESA wireless communication protocol independent from WiFi or Bluetooth
- Autonomy 40 hours (rechargeable battery).
- Support structure \varnothing 8 mm with enhanced clamping over its entire length
- Measuring rod mounted on ball bearing.
- Separate guide bearing on the holding body in order not to negatively influence the movement of the measuring rod in the event of improper clamping of the probe beads.
- Level of protection IP54 according to IEC 60529.
- Wide range of measurement probes.
- The TWIN-STATION (part number 05030012) manages and synchronizes up to 8 wireless probes.
- Interface Software TIS included in delivery content of the TWIN-STATION (art. 05030012): display of measured values, possibility to indicate tolerances, simple functions +A, -A, +A+B, +A-B, and export of values in a .csv file.

Note: The sales is limited to EU countries, Switzerland, USA, Canada and China.



GTL 212 W

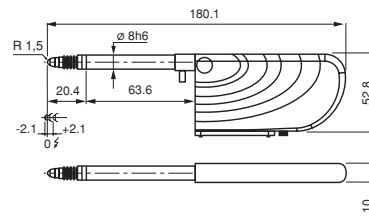

GTL 212 W

No	Model	Measuring range, mm	Nominal measuring force*, N	Bolt retraction	Sealing bellows	Nominal/maximal pressure, bar
03230501	GTL 212	$\pm 1,5$	1,2	Pressure (bolt activation), spring (bolt retraction)	Viton	0,7 / max. 1,0

OPTIONAL ACCESSORY:

05030012 TWIN-STATION Interface for wireless probes

Model	Max. measuring bolt travel, mm	Maximum permissible error, μ m (L in mm)	Repeatability, μ m	Hysteresis, μ m	Setting of lower stop of the measuring bolt***, mm	Cable output	Data sheet No.
GTL 212 W	4,3	0,4 + 0,8 · L	0,10	0,5	Fixed stops: lower -2,1 upper +2,1	Without cable	03200620

* Electrical zero (N) ± 25 % deviation limit. Valid in vertical mounting position, measuring bolt lowered and in static measuring.

** For an amplitude of 10 % to the last value of the measuring range.

*** Distance from electrical zero.

- N** DIN 32876 Part 1
- B** Nickel-plated housing
Stainless steel measuring bolt, hardened
Viton sealing bellows = highly resistance fluoroe-lastomer
- A** Fixing body nickel \varnothing 8 mm
Stainless steel measuring bolt, hardened and ball bearing guided
Fixed upper and lower stops
Probe interchangeable
M2,5 thread
Carbide ball \varnothing 3 mm
Mini jack connector for charger.
- B** Mechanical max. frequency**: 60 Hz
Power supply: 100 \div 240 VAC, 50 \div 60 Hz; 240 mAh
Rechargeable battery: 3,7 V, min. 550 mAh or 800 mAh
Frequency band: 2,4 GHz Range: 8 m, depending on environment.
- B** Wireless transmission, TWIN-STATION Receiver (05030012)
- $\pm 0,2 \mu\text{m}/^\circ\text{C}$
- $20 \pm 0,5^\circ\text{C}$
- Protection IP54 (IEC 60529)
- GTL 212 W: 6g
- Inspection report with a declaration of conformity



N DIN 32876 Part 1

Nickel-plated housing
Stainless steel measuring bolt, hardened
Viton sealing bellows = highly resistance fluoroelastomer

A Fixing body nickel \varnothing 8 mm
Stainless steel measuring bolt, hardened and ball bearing guided
Fixed upper and lower stops
Probe interchangeable
M2,5 thread
Carbide ball \varnothing 3 mm
Mini jack connector for charger

Mechanical max. frequency**: 60 Hz
Power supply: 100 \div 240 VAC, 50 \div 60 Hz; 240 mAh
Rechargeable battery: 3,7 V, min. 550 mAh or 800 mAh
Frequency band: 2,4 GHz
Range: 8 m, depending on environment.

Wireless transmission, TWIN-STATION Receiver (05030012)

$\pm 0,2 \mu\text{m}/^\circ\text{C}$

$20 \pm 0,5^\circ\text{C}$

Protection level IP54 (IEC 60529)

GT 612 W: 8 g

Inspection report with a declaration of conformity

Wireless Pneumatic Probe ± 5 mm, Large Measuring Range

Probes developed for devices requiring a greater freedom of movement during the measurement or for pieces with large dimensions.

Bidirectional and wireless communication synchronized with the TWIN-STATION Receiver.

- Resolution 0,1 μm .
 - Range of 8 m, depending on environment.
 - TESA wireless communication protocol independent from WiFi or Bluetooth.
 - Autonomy 40 hours (rechargeable battery).
 - Mounting body \varnothing 8 mm with enhanced clamping over its entire length.
 - Measuring bolt mounted on ball bearing.
 - Separate guide bearing on the holding body in order not to negatively influence the movement of the measuring bolt in the event of improper clamping on the probe body.
 - Level of protection IP54 according to IEC 60529.
 - Wide range of measurement probes.
 - The TWIN-STATION (part number 05030012) manages and synchronizes up to 8 wireless probes.
 - Interface Software TIS included in delivery content of the TWIN-STATION (art. 05030012): display of measured values, possibility to indicate tolerances, simple functions +A, -A, +A+B, +A-B, and export of values in a .csv file.
- Note: The sales is limited to EU countries, Switzerland, USA, Canada and China.



GT 612 W

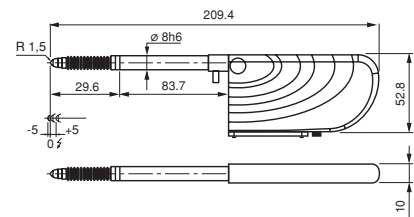

GT 612 W

No		Measuring range, mm	Nominal measuring force*, N	Bolt retraction	Sealing bellows	Nominal/maximal pressure, bar
03230503	GT 612 W	± 5	2,0	Pressure (bolt activation), spring (bolt retraction)	Viton	1,1 / max. 1,5

OPTIONAL ACCESSORY:

05030012 TWIN-STATION Interface for wireless probes

	Max. bolt travel, mm	Maximum permissible error, μm (L in mm)	Repeatability, μm	Hysteresis, μm	Setting of lower stop of measuring bolt***, mm	Cable output	Data sheet No.
GT 612 W	10,3	$0,8 + 0,8 \cdot L$	0,24	0,5	Fixed stops: lower -5 upper +5	Without cable	03200622

* Electrical zero (N) ± 25 % deviation limit. Valid in vertical mounting position, measuring bolt lowered and in static measuring.

** For an amplitude of 10 % to the last value of the measuring range.

*** Distance from electrical zero.



USB Probes ± 2 mm, 4,3 mm Range

Universal probes for applications aided by a USB connection.

- Probe mounting body Ø 8 mm with enhanced clamping over its entire length.
- Measuring bolt mounted on ball bearing.
- Separate guide bearing on the mounting body in order not to negatively influence the movement of the measuring bolt in the event of improper clamping of the probe beads.
- Level of protection IP65 according to IEC 60529.
- Wide range of measurement inserts.
- TSIP software interface included in supply 1 to 4 USB probes display.
- Possibility of indicating tolerances and simple functions + A, -A, + A + B + AB.
- To manage more than 4 probes USB, use the DATA-DIRECT (part number 04981001) or STAT-EXPRESS software (part number 04981002), available as an option.



TSIP Software

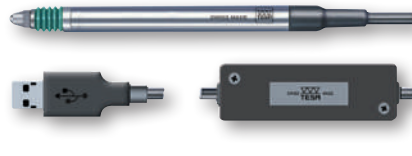

GTL 21 USB

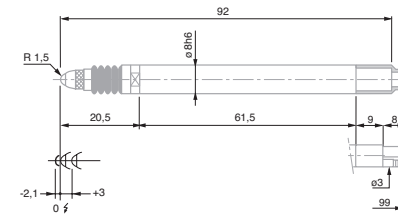

GTL 21 USB



GTL 22 USB

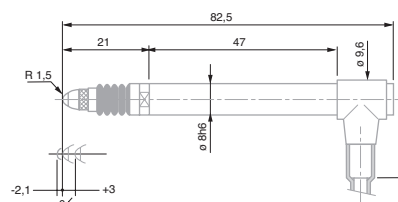

GTL 22 USB

- DIN 32876 Part 1
- Nickel-plated housing. Stainless steel measuring bolt, hardened. Viton sealing bellows = highly resistant fluoroelastomer
- Fixing body Ø 8 mm. Measuring bolt guided on ball bearing. Fixed upper and lower stops. Interchangeable inserts. M 2,5 thread. Carbide ball Ø 3 mm. Cable length: 2,9 m. USB Type A plug connector
- Max. mechanical frequency** 60 Hz. Consumption: 70 mAh, 5V. Normal measuring interval = 80ms (optimal accuracy). Minimal measuring interval = 20ms (most rapid transfer of data). Stabilisation time after switching power on = 12 min.
- 0,2 µm/°C
- 20 ± 0,5°C
- IP65 (IEC 60529)
- Mobile weight: 6 g
- Inspection report with a declaration of conformity

		Measuring range, mm	Nominal measuring force*, N	Bolt retraction	Sealing bellows
03230200	GTL21 USB	± 2	0,63	Mechanical	Viton
03230201	GTL 22 USB	± 2	0,63	Mechanical / vacuum	Viton

	Measuring bolt travel, mm	Max. permissible error, µm (L in mm)	Repeatability, µm	Hysteresis, µm	Setting of lower stop of measuring bolt*** mm	Cable output	Data sheet No.
GTL21 USB	4,3	0,4 + 0,8 · L	0,1	0,5	Fixed stops: lower -2,0 upper +2,0	Axial	03200587
GTL 22 USB	4,3	0,4 + 0,8 · L	0,1	0,5	Fixed stops: lower -2,0 upper +2,0	Radial	03200588

* Electrical zero (N) ± 25 % deviation limit. Valid in vertical mounting position, measuring bolt lowered and in static measuring.

** For an amplitude of 10 % to the last value of the measuring range.

*** Distance from electrical zero.

USB Pneumatic Probes ± 1,5 mm, 3,1 mm Bolt Travel

Universal probes for applications facilitated by a USB connection

- Mounting body Ø 8 mm with possibility of clamping over its entire length.
- Measuring rod mounted on ball bearing.
- Separate guide bearing on the holding body in order not to negatively influence the movement of the measuring bolt in the event of improper clamping of the probe beads.
- Level of protection IP65 or IP50 according to IEC 60529.
- Wide range of measurement inserts.
- TSIP software interface included in supply: display 1 to 4 USB probes. Possibility of indicating tolerances and simple functions + A, -A, + A + B + AB.
- To manage more than 4 probes USB, use the DATA-DIRECT (part number 04981001) or STAT-EXPRESS software (part number 04981002), available as an option.

N DIN 32876 Part 1

***** Nickel-plated housing, Stainless steel measuring bolt, hardened. Viton sealing bellows = highly resistant fluoroelastomer

A Fixing shank Ø 8 mm. Measuring bolt on ball bearing guide. Fixed lower and upper stops. Interchangeable measuring insert. Thread M2,5. Carbide ball Ø 3 mm Cable length: 2,9 m USB type A connector

***** Max. mechanical frequency** 60 Hz.
Consumption: 70 mAh, 5V
Normal measuring interval = 80 ms (optimal accuracy)
Minimal measuring interval = 20 ms (most rapid transfer of data)
Stabilisation time after switching power on = 12 min.
Remark: Compressed air supply must be generated through a filter and precision regulator. The air should have a humidity of < 60 % and be filtered to < 0,5 µm.

***** 0,2 µm/°C

***** 20 ± 0,5°C

***** IP65 (IEC 60529) or IP50 for GTL222-A

***** Mobile weight: 6 g

***** Inspection report with a declaration of conformity



GTL222 USB

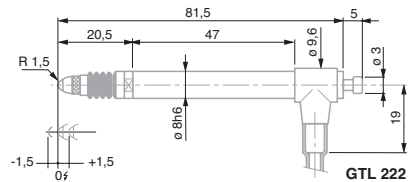

GTL222 USB



TSIP Software

		Measuring range, mm	Nominal measuring force*, N	Bolt retraction	Sealing bellows	Nominal/Maximal Pressure, bar
03230202	GTL222 USB	± 1,5	1,2	Pressure (bolt activation), spring (bolt retraction)	Viton	0,7 / max 1,0

	Measuring bolt travel, mm	Max. permissible error, µm (L in mm)	Repeatability, µm	Hysteresis, µm	Cable output	Data sheet No.
GTL222 USB	3,1	0,4 + 0,8 · L	0,1	0,5	Radial	03200589

* Electrical zero (N) ± 25 % deviation limit. Valid in vertical mounting position, measuring bolt lowered and in static measuring.
** For an amplitude of 10 % to the last value of the measuring range.



USB Probes ± 5 mm, 10,3 mm Bolt Travel, Extended Measuring Range

USB universal probes for applications facilitated by a USB connection.

- Probes designed for long measuring travel and low resolution measurement values.
- Probe mounting body Ø 8 mm with possibility of clamping over its entire length.
- Measuring bolt mounted on ball bearing.
- Separate guide bearing on the holding body in order not to negatively influence the movement of the measuring bolt in the event of improper clamping of the probe beads.
- Level of protection IP65 according to IEC 60529.
- Wide range of measurement inserts.
- TSIP software interface included in supply 1 to 4 USB probes display. Possibility of indicating tolerances, simple functions + A, -A, + A + B + AB.
- To manage more than 4 USB probes, use the DATA-DIRECT (part number 04981001) or STAT-EXPRESS software (part number 04981002), available as an option.



GT 61 USB

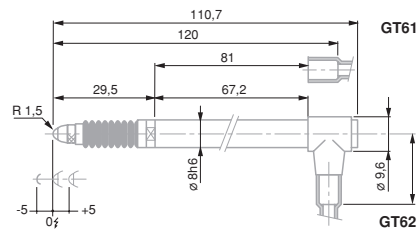

GT 61 USB / GT 62 USB



TSIP Software

		Measuring range, mm	Nominal measuring force*, N	Bolt retraction	Sealing bellows
03230204	GT61 USB	± 5	0,90	Mechanical	Viton
03230205	GT62 USB	± 5	0,90	Mechanical / vacuum	Viton

	Measuring bolt travel, mm	Max. permissible error, µm (L in mm)	Repeatability, µm	Hysteresis, µm	Settings of lower stop of bolt***, mm	Cable output	Data sheet No.
GT61 USB	10,3	0,8 + 0,8 · L	0,24	0,5	Fixed stops: lower -5,0 upper +5,0	Axial	03200591
GT62 USB	10,3	0,8 + 0,8 · L	0,24	0,5	Fixed stops: lower -5,0 upper +5,0	Radial	03200592

* Electrical zero (N) ± 25 % deviation limit. Valid in vertical mounting position, measuring bolt lowered and in static measuring.

** For an amplitude of 10 % to the last value of the measuring range.

*** Distance from electrical zero.

- DIN 32876 Part 1
- Nickel-plated housing. Stainless steel measuring bolt, hardened. Viton sealing bellows = highly resistant fluoroelelastomer
- Fixing shank Ø 8 mm. Measuring bolt guided on ball-bearing. Distance from electrical zero of both stops is either adjustable (downward) or depending on the position of the lower stop (upward). Interchangeable inserts. M2,5 thread. Carbide ball tip Ø 3 mm. Cable length 2,9 m. USB type A connector. 5-pin DIN 45322 connector.
- Max. mechanical frequency 60 Hz
Power consumption: 70 mAh
Normal measurement interval = 80ms (maximum accuracy)
Minimum measurement interval = 20ms (fastest transfer data).
Stabilisation time after power on = 12 min

- 0,09 µm/°C
- 20 ± 0,5°C
- IP65 (IEC 60529)
- Mobile weight: 8 g
- Inspection report with a declaration of conformity



N DIN 32876 Part 1

See standard probes technical data

A Cable length: 2 m. DIN 45322 plug connector, 5 poles. Use to connect to a device with an analogue input. For more information, refer to technical data for standard probes

Supply voltage: ± 15 V
Consumption: 15 mA
Adjustable load: > 1 k Ω . Can be used in any position.
Special versions on request: Sensitivity: 2 V/mm, 5 V/mm, 10 V/mm output: 0 V to +10 V (max +10 V)

See standard probes technical data

See standard probes technical data

See standard probes technical data

See standard probes technical data

See standard probes technical data

DC Probes ± 2 mm (Output Signal in V)

Probe provided with an electronic box which converts the signal to obtain an output DC voltage

Typically used for direct connection to a computer unit or interface equipped with an analogue input



GTL 21 DC

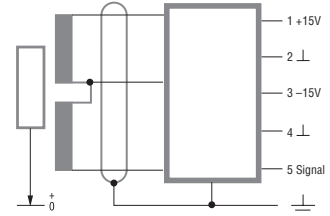

DIN 5 pin connection schematic

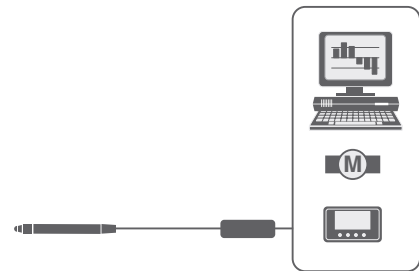

Connection of DC probe to a computer, an interface or a tracker

			Measuring range, mm	Nominal measuring force*, N	Bolt retraction	Sealing bellows	Output voltage, V	Sensitivity, V/mm
03230059	GTL 21 DC		± 2	0,63	Mechanical	Viton	± 2	1
03230058	GTL 22 DC		± 2	0,63	Mechanical / vacuum	Viton	± 2	1

		Measuring bolt travel, mm	Max. permissible error for deviations in linearity, μ m (L in mm)	Repeatability, μ m	Data sheet No.
GTL 21 DC		4,3	$0,2 + 3,5 \cdot L^2$	0,1	03200396
GTL 22 DC		4,3	$0,2 + 3,5 \cdot L^2$	0,1	03200397

* Electrical zero (N) ± 25 % deviation limit. Valid in vertical mounting position, measuring bolt lowered and in static measuring.



DC Probes ± 5 mm (Output Signal in V), with Extended Measuring Range

Probe provided with an electronic box which converts the signal to obtain an output DC voltage

Typically used for direct connection to a computer unit or an interface equipped with an analogue input

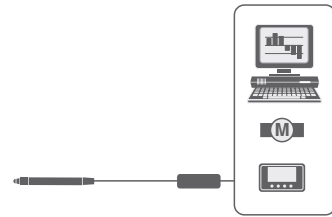

Connection of DC probe to a computer, an interface or a plotter

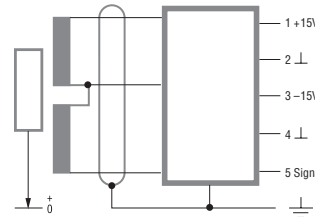

DIN 5 pin connector schematic

- DIN 32876 Part 1
- See standard probes technical data
- Cable length: 2 m. DIN 45322 plug connector, 5 poles. Use to connect to a device with an analogue input. For more information, refer to technical data on standard probes
- Supply voltage: ± 15 V
Consumption: 15 mA
Adjustment load: > 1 kΩ
Can be used in any position. Special versions on request. Sensitivity: 2 V/mm, 5 V/mm, 10 V/mm
Output: 0 V to +10 V (max +10 V).
- See standard probes technical data
- See standard probes technical data
- See standard probes technical data
- See standard probes technical data
- See standard probes technical data

		Measuring range, mm	Nominal measuring force*, N	Bolt retraction	Sealing bellows	Output voltage, V	Sensitivity, V/mm
03230086	GT 61 DC	± 5	0,9	Mechanical	Viton	± 5	1
03230087	GT 62 DC	± 5	0,9	Mechanical / vacuum	Viton	± 5	1

	Measuring bolt travel, mm	Max. permissible error for deviations in linearity, μm (L in mm)	Repeatability, μm	Data sheet No.
GT 61 DC	10,3	1 + 4 · L	0,1	03200519
GT 62 DC	10,3	1 + 4 · L	0,1	03200520

* Electrical zero (N) ± 25 % deviation limit. Valid in vertical mounting position, measuring bolt lowered and in static measuring.



N DIN 32876 Part 1

See standard probes technical data

A Cable length: 2 m. DIN 45322 plug connector, 5 poles. Use to connect to a device with an analog input. For more information, refer to technical data for standard probes

Drive voltage: ± 15 V
Consumption: 15 mA
Adjustment load: > 1 k Ω . Can be used in any position. Special versions on request. Sensivity: 2 V/mm, 5 V/mm, 10 V/mm Output: 0 V \dot{a} +10 V (max +10 V)

See standard probes technical data

See standard probes technical data

See standard probes technical data

See standard probes technical data

See standard probes technical data

DC Miniature Probes ± 1 mm (Output Signal in V)

Probe provided with an electronic box which converts the signal to obtain an output DC voltage

Typically used for direct connection to a computer unit or an interface equipped with an analogue input

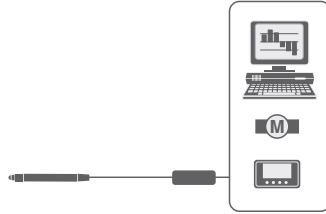

Connection of a DC probe to a computer, an interface or a plotter

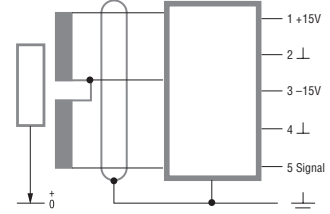

DIN 5 pin connection schematic

No	=	Measuring range, mm	Nominal measuring force*, N	Bolt retraction	Sealing bellows	Output voltage, V	Sensitivity, V/mm
03230085	GT 44 DC	± 1	0,4	Mechanical / vacuum	Viton	± 1	1

=	Measuring bolt travel, mm	Max. permissible error for deviations in linearity, μ m (L en mm)	Repeatability, μ m	Data sheet No.
GT 44 DC	2,1	$0,2 + 5 \cdot L^3$	0,1	03200518

* Electrical zero (N) ± 25 % deviation limit. Valid in vertical mounting position, measuring bolt lowered and in static measuring.



DC Miniature Probes ± 0,3 mm (Output Signal in V)

Probe provided with an electronic box which converts the signal to obtain an output DC voltage

Typically used for direct connection to a computer unit or an interface equipped with an analogue input

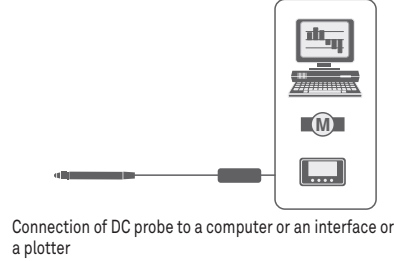
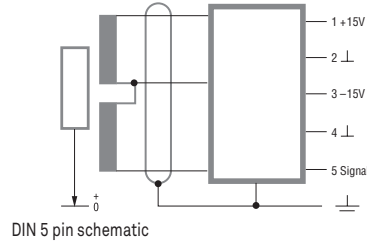

03230081	GT31 DC	Measuring range, mm	Nominal measuring force*, N	Bolt retraction	Sealing bellows	Output voltage, V	Sensitivity, V/mm
		± 0,3	0,1	Without retraction	Without bellows	± 0,3	1

GT31 DC	Measuring bolt travel, mm	Max. permissible error for deviations in linearity, µm (L in mm)	Repeatability, µm	Data sheet No.
	0,7	0,2 + 50 · L ²	0,1	03200484

* Electrical zero (N) ± 25 % deviation limit. Valid in vertical mounting position, measuring bolt lowered and in static measuring.

- DIN 32876 Part 1
- See standard probes technical data
- Cable length: 2 m. DIN 45322 plug connector, 5 poles. Use to connect to a device with an analogue input. For more information, refer technical data on standard probes
- Drive voltage: ± 15 V
Consumption: 15 mA
Adjustment load: > 1 kΩ. Can be used in any measuring position. Special versions on request.
Sensitivity: 2 V/mm, 5 V/mm, 10 V/mm
Output: 0 V to +10 V (max +10 V)
- See standard probes technical data
- See standard probes technical data
- See standard probes technical data
- See standard probes technical data
- See standard probes technical data



N DIN 32876 Part 1

***** Nickel-plated housing. Stainless steel measuring bolt, hardened. Sealing bellows: Nitrile = resistant elastomer. Viton = highly resistant fluoroelastomer.

A Fixing shank Ø 8 mm. Ball-bearing measuring bolt. Both lower and upper stops are fixed. Interchangeable insert. M2,5 thread. Carbide ball tip Ø 3 mm. 2 m long cable. 5-pin DIN 45322 connector.

***** Supply frequency: 13 kHz (± 5 %) Max. mechanical frequency** 60 Hz.

***** 0,1 µm/°C

***** 20 ± 0,5°C

***** Level of protection: IP65 (IEC 60529)

***** Mobile weight: 2 g

***** Inspection report with a declaration of conformity

GT 41 / GT 42 Miniature Probes, ± 0,3 mm, 0,7 mm Bolt Travel

Compact probes for use in small spaces – Designed to be mounted on a measuring head for the inspection of bores and similar features.



GT 41

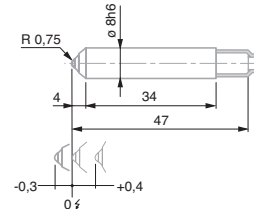

GT 41



GT 42

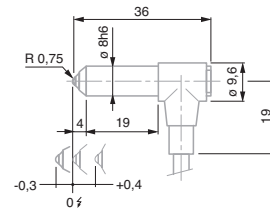

GT 42

No	=	Measuring range, mm	Nominal measuring force*, N	Bolt retraction	Sealing bellows
03230001	GT 41	± 0,3	0,63	None	Nitrile
03230002	GT 42	± 0,3	0,63	Vacuum	Nitrile

	=	Measuring bolt travel, mm	Max. permissible error for deviations in linearity, µm (L en mm)	Repeatability, µm	Hysteresis, µm	Setting of lower stop of measuring bolt***, mm	Cable output	Data sheet No.
GT 41	0,7	0,2 + 5 · L ²	0,01	0,01	Fixed stops: lower -0,3 upper +0,4	Axial	03200258	
GT 42	0,7	0,2 + 5 · L ²	0,01	0,01	Fixed stops: lower -0,3 upper +0,4	Radial	03200259	

* Electrical zero (N) ± 25 % deviation limit. Valid in vertical mounting position, measuring bolt lowered and in static measuring.

** For an amplitude of 10 % to the last value of the measuring range.

*** Distance from electrical zero.



GT 43 / GT 44 Miniature Probes ± 1,0 mm, 2,1 mm Bolt Travel

Compact probes for use in small spaces – Designed to be mounted on a measuring head for the inspection of bores and similar features.



GT 43

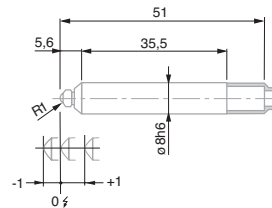

GT 43



GT 44

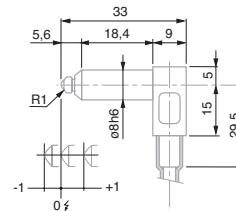

GT 44

- DIN 32876 Part 1
- Nickel-plated housing. Stainless steel measuring bolt, hardened. Sealing bellows: Nitrile = resistant elastomer. Viton = highly resistant fluoroelastomer.
- Fixing shank Ø 8 mm. Ball-bearing measuring bolt. Both lower and upper stops are fixed. Interchangeable insert. M2 thread. Carbide ball tip Ø 3 mm. 2 m long cable, 5-pin DIN 45322 connector.
- Supply frequency: 13 kHz (± 5 %) Max. mechanical frequency**: 60 Hz.
- 0,1 µm/°C
- 20 ± 0,5°C
- Level of protection: IP65 (IEC 60529)
- Mobile weight: 2 g
- Inspection report with a declaration of conformity

		Measuring range, mm	Nominal measuring force*, N	Bolt retraction	Sealing bellows
03230035	GT 43	± 1	0,4	Mechanical	Viton
03230017	GT44	± 1	0,4	Vacuum	Viton

Measuring bolt travel, mm	Max. permissible error for deviations in linearity, µm (L en mm)	Repeatability, µm	Hysteresis, µm	Setting of lower stop of bolt***, mm	Cable output	Data sheet No.	
GT 43	2,1	0,2 + 5 · L ²	0,1	0,15	Fixed stops: lower -1,05 upper +1,05	Axial	03200260
GT44	2,1	0,2 + 5 · L ²	0,1	0,15	Fixed stops: lower -1,05 upper +1,05	Radial	03200261

* Electrical zero (N) ± 25 % deviation limit. Valid in vertical mounting position, measuring bolt lowered and in static measuring.

** For an amplitude of 10 % to the last value of the measuring range.

*** Distance from electrical zero.



N DIN 32876
Part 1

***** Nickel-plated housing. Stainless steel measuring bolt, hardened. Sealing bellows: Nitrile = resistant elastomer

A Fixing shank Ø 8 mm. Ball-bearing measuring bolt. Distance from electrical zero of both stops is either adjustable (downward) or depending on the position of the lower stop (upward). Interchangeable measuring insert with a 3 mm dia. tungsten carbide ball tip plus M2,5 thread. 2 m long cable. DIN 45322 5-pin connector.

***** Supply frequency: 13 kHz (± 5 %) Max. mechanical frequency**: 60 Hz.

***** 0,025 µm/°C

***** 20 ± 0,5°C

***** IP65 (IEC 60529)

***** Mobile weight: 3,1 g

Probes, Unbranded Execution, Series 410 ± 1 mm, 2,5 mm Range, Short Body

Universal probes for common but constraining applications.

- 8 mm diameter probe body that can be clamped over its entire length.
- Ball bearing measuring bolt.
- Hardened steel body, hard-chrome plated.
- Degree of protection to IP62.
- Flexible axial cable exit fitted with a steel spring to prevent the cable from breaking.
- Other probes compatible with measuring equipment from other makers also available on request.



410

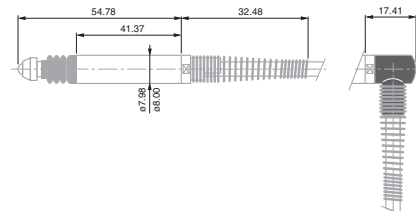

410 and accessory with radial cable exit (delivered with probe)

No	=	 	✋	*	*
	Measuring range, mm	Nominal measuring force*, N	Bolt retraction	Sealing bellows	
96410012	410	± 1	0,60	Mechanical	Nitrile

=	 	0↔	↕	A	*	⚠
Measuring bolt travel, mm	Max. permissible error for deviations in linearity, µm (L en mm)	Repeatability, µm	Setting of lower stop of the measuring bolt***, mm (factory setting)	Cable output	Data sheet No.	
410	2,5	0,2 % (for a measuring span of ± 1 mm)	0,1	Adjustable from -1,2 to 0 (factory setting -1,08)	Axial and radial	F96410012

* Electrical zero (N) ± 25 % deviation limit. Valid in vertical mounting position, measuring bolt lowered and in static measuring.

** For an amplitude of 10 % to the last value of the measuring range.

*** Distance from electrical zero.



Probes, Unbranded Execution, Series 160 ± 1 mm, 3,3 mm Bolt Travel, Short Body, Ø 6 mm

Compact size and robust construction makes these probes ideal for continuous use.

- Probe body Ø 6 mm.
- Clamping possible over entire length.
- Measuring bolt guided on ball bearing.
- Hard-chrome plated probe body, hardened steel.
- Protection level: IP62 as per IEC 60529.
- Executions compatible with measuring equipment from other suppliers available on request.

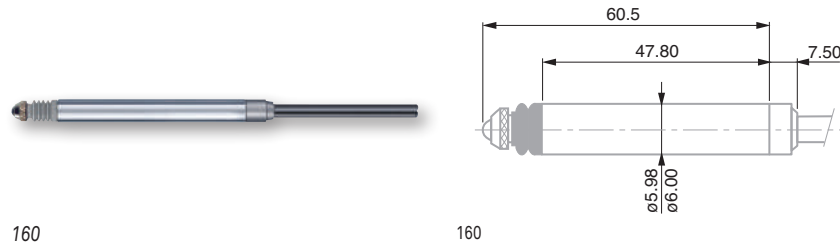

160

160

		Measuring range, mm	Nominal measuring force*, N	Bolt retraction	Sealing bellows
96160013	160	± 1	0,60	Mechanical	Viton

Measuring bolt travel, mm	Max. permissible error for deviation in linearity, µm (L in mm)	Repeatability, µm	Setting of lower stop of measuring bolt***, mm (factory setting)	Cable output	Data sheet No.	
160	3,3	0,2 % (for a measuring span of ± 1 mm)	0,1	Adjustable from -1,2 to 0 (factory setting -1,08)	Axial	F96160013

* Electrical zero (N) ± 25 % deviation limit. Valid in vertical mounting position, measuring bolt lowered and in static measuring.

** For an amplitude of 10 % to the last value of the measuring range.

*** Distance from electrical zero.

DIN 32876 Part 1

Nickel-plated housing. Stainless steel measuring bolt, hardened. Sealing bellows: Viton = highly resistant fluoroelastomer.

Probe body Ø 6 mm. Measuring bolt guided on ball bearing. Distance between the lower stop and electrical zero adjustable. Interchangeable measuring insert. Thread M2. Carbide ball tip Ø 3 mm. 2 m long cable. DIN 45322 5-pin connector.

Supply frequency: 13 kHz (± 5 %) Max. mechanical frequency**: 60 Hz.

0,025 µm/°C

20 ± 0,5°C

Protection level: IP62 (IEC 60529)

Mobile weight: 2,5 g



N DIN 32876 Part 1

***** Nickel-plated housing. Stainless steel measuring bolt, hardened. Sealing bellows: Nitrile = resistant elastomer.

A Probe body Ø 8 mm. Measuring bolt guided on ball bearing. Adjustable distance between lower bolt and electrical zero. Interchangeable measuring insert. Thread M2,5. Carbide ball tip Ø 3 mm. Cable length: 2 m DIN 45322 5-pin connector.

***** Supply frequency: 13 kHz (± 5 %) Max. mechanical frequency**: 60 Hz..

***** 0,025 µm/°C

***** 20 ± 0,5°C

***** Level of protection: IP65 (IEC 60529)

***** Mobile weight: 1,9 g (Series 430)
Mobile weight: 3,0 g (Series 451)

Probes, Unbranded Execution, Series 430 and 451, ± 0,5 mm, 1,25 et 2,10 mm Measuring Bolt Travel, Miniature

Their compact size and robust construction make them the ideal probes for a frequent use.

- Probe body Ø 8 mm.
- Clamping possible over its entire length.
- Measuring bolt on ball bearing guide.
- Hard chrome-plated probe body, hardened steel.
- Level of protection: IP62 as per IEC 60529.
- Probes compatible with measuring equipment from other suppliers also available on request.

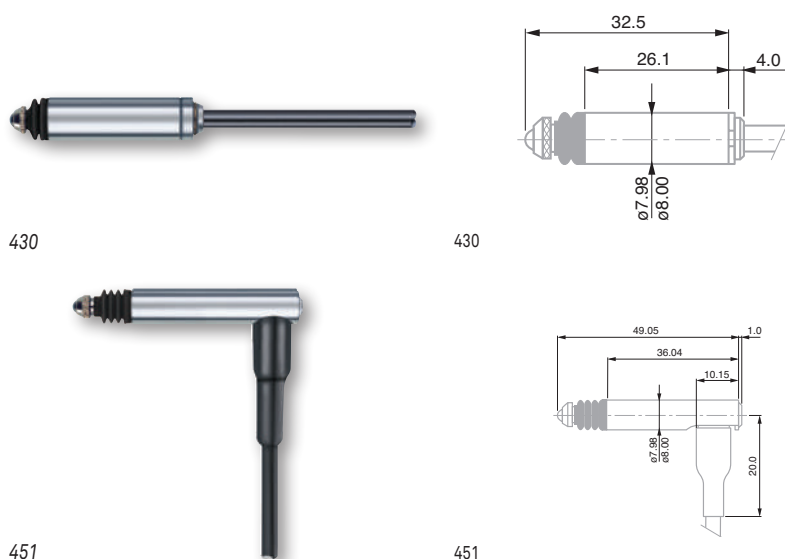

	No	=	 	✋	*	*
			Measuring range, mm	Nominal measuring force*, N	Bolt retraction	Sealing bellows
96430029	430		± 0,5	0,75	Mechanical	Nitrile
96441041	451		± 0,5	0,60	Mechanical	Nitrile

	=	 	0	↕	A	*	⚠
	Measuring bolt travel, mm	Max. permissible error for deviations in linearity, µm (L in mm)	Repeatability, µm	Setting of lower stop of measuring bolt***, mm (factory setting)	Cable output	Data sheet Nb	
430	1,25	0,2 % (for a measuring span of ± 0,5 mm)	0,2	Adjustable from -0,7 to 0 (factory setting -0,58)	Axial	F96430029	
451	2,10	0,2 % (for a measuring span of ± 0,5 mm)	0,1	Fixed stops (factory setting: -0,58)	Radial	F96441041	

* Electrical zero (N) ± 25 % deviation limit. Valid in vertical mounting position, measuring bolt lowered and in static measuring.

** For an amplitude of 10 % to the last value of the measuring range.

*** Distance from electrical zero.



GT31 Lever Probes ± 0,3 mm, 0,3 mm Measuring Travel, Inclinable Lever



GT 31 with lever in perpendicular position

Well suited for use where probes with axial movement measuring bolts are inconvenient for measurements.

- Inclinable lever for measuring in two directions.
- Balanced lever system on ball-bearing.
- Interchangeable measuring insert, with carbide ball tip, inclinable through to 180°.
- Automatic reversal of the probing direction while the indication remains unchanged.
- Protected against shocks by 2 safety clutches.
- One-piece housing provided with 2 dovetails.
- Level of protection: IP40 as per IEC 60529.

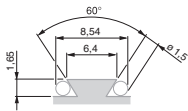

GT 31

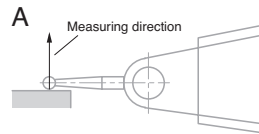

GT 31
Figure A - the leverage matches 1:1, no correction of the measured value needed

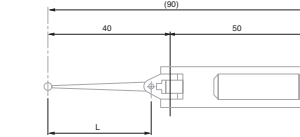
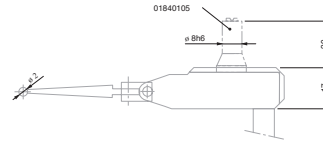

GT 31 side view and top view

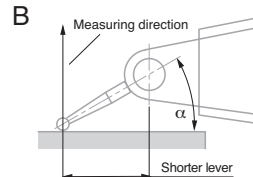

GT 31
Figure B - the leverage is no longer 1:1, correction of the measured value is needed.

Note
(Fig. A) With the insert lying parallel to the workpiece surface, the leverage matches 1:1. Therefore, no correction of the measured values is needed.
(Fig. B, angle α) Any other position will change the effective lever length, so that read values must be corrected. In this connection, please consult the instruction manual.

			Measuring range, mm	Nominal measuring force*, N	Lever retraction	Sealing bellows
03210802	GT 31	± 0,3	0,1	Without	Without bellows	
03210801	GT 31	± 0,3	0,02	Without	Without bellows	
03210803	GT 31	± 0,3	0,2	Without	Without bellows	

	Measuring lever travel, mm	Max. permissible error for deviations in linearity, μm (L in mm)	Repeatability, μm	Hysteresis, μm	Setting of lower stop of the measuring insert***, mm	Cable output	Data sheet No.
GT 31	0,7	$0,2 + 50 \cdot L^2$	0,1	0,25	Fixed lower and upper stops	Angled	03200266

* Electrical zero (N) ± 25 % deviation limit. Valid in vertical mounting position, measuring bolt lowered and in static measuring.
** For an amplitude of 10 % to the last value of the measuring range.
*** Distance from electrical zero.

- DIN 32876 Part 1
- All-metal housing, matt-chromium finish
- 2 dovetail attachments for clamping. Both lower and upper stops are fixed. Stainless steel measuring stem. Interchangeable measuring inserts. Carbide ball tip $\varnothing 2$ mm. Cable length: 2 m. DIN 45322, 5 pin connector. Other measuring inserts available as optional accessories..
- Supply frequency: 13 kHz ($\pm 5\%$) Max. mechanical frequency**: 25 Hz.
- $20 \pm 0,5^\circ\text{C}$
- Protection level: IP40 (IEC 60529)
- Mobile weight: 12 g



N DIN 32876 Part 1

A Hardened steel probe body, nickel-plated

A Linear guidance on ball bearing. 4 M6 mounting threads. Fixed mechanical stops. Interchangeable inserts. Dovetail clamp for mounting holder. Cable length: 2 m. 5-pin connector DIN 45322.

A Supply frequency: 13 kHz (± 5 %) Max. mechanical frequency**: 25 Hz.

A -0,14 µm/°C

A 20 ± 0,5°C

A IP50 (IEC 60529)

A Mobile weight: 110 g

A Inspection report with a declaration of conformity



Application: Minimal space usage with FMS units placed side by side



Application: small component measuring thanks to offset inserts

Probes with Parallel Guidance, ± 2 mm or ± 2,9 mm, 5,8 mm Measuring Travel

Modular construction enables the combination of elements, for example, such as springs, pneumatic cylinders and stops.

These universal probes are suited for multigauging fixtures as well as machines equipped with integrated inspection routines.

Versatility of applications:

- Probe can be used in any position for measuring.
- Measuring direction is adjustable.
- Retraction of the measuring insert is adjustable.
- Measuring force is adjustable depending on the accessory used.
- Possibility of using off-centre measuring inserts.

Unique design:

- Compact assembly noted for its robustness.
- Ball bearing guided movement.
- Wide variety of measuring inserts, holders and other accessories for measuring applications.
- LVDT execution versions compatible with melectronic equipment from other suppliers available on request.

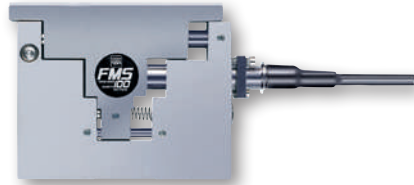

FMS 100



FMS 102

No	=	Measuring range, mm	Nominal measuring force*, N	Ball retraction	Sealing bellows
03230019	FMS 100	± 2	2	Retraction by air pressure (optional)	Without bellows
03230049	FMS 130	± 2,9	2	Retraction by air pressure (optional)	Without bellows
03230028	FMS 102	± 2	2	Retraction by air pressure (optional)	Without bellows
03230050	FMS 132	± 2,9	2	Retraction by air pressure (optional)	Without bellows

=	Measuring bolt travel, mm	Max. permissible error for deviation in linearity, µm (L in mm)	Repeatability, µm	Hysteresis, µm	Setting of lower stop of measuring bolt***, mm	Cable output	Data sheet No.
FMS 100	5,8	0,2 + 3 · L ³	0,5	0,5	Fixed stops: lower -2,9 upper +2,9	Parallel	03200253
FMS 130	5,8	0,2 + 3 · L ³	0,5	0,5	Fixed stops: lower -2,9 upper +2,9	Parallel	03200342
FMS 102	5,8	0,2 + 3 · L ³	0,5	0,5	Fixed stops: lower -2,9 upper +2,9	Parallel	03200254
FMS 132	5,8	0,2 + 3 · L ³	0,5	0,5	Fixed stops: lower -2,9 lower +2,9	Parallel	03200343

* Electrical zero (N) ± 25 % deviation limit. Valid in vertical mounting position, measuring bolt lowered and in static measuring.

** For an amplitude of 10 % to the last value of the measuring range.

*** Distance from electrical zero.



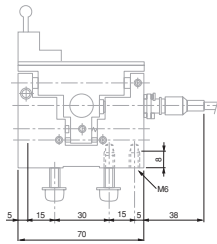

FMS 100

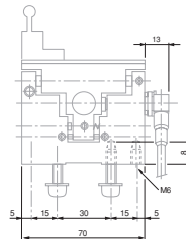

FMS 102

Configuration and Application of TESA FMS Probes

Shown below are the different possibilities for the activation and retraction of the probe insert during measurement cycles.

APPLICATION EXAMPLE A

- Activation of the probe insert in the direction of the part to be inspected using the measuring force produced by the spring set.
- Without retraction of the insert.

Result A
During the placing of a new part to be measured, the measuring insert remains in its contact position thanks to the measuring force produced by the spring set.

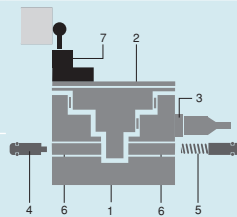

- 1 Static probe body
- 2 Mobile probe body
- 3 Measuring element with fine adjust
- 4 Adjustable stop
- 5 Spring set for producing measuring force
- 6 M6 mounting thread
- 7 Holder

APPLICATION EXAMPLE B

- Activation of the probe insert in the direction of the part to be measured using the measuring force of the spring set.
- Retraction of the insert by pneumatic pressure through a pneumatic connection.

Result B
During the placing of a new part to be measured, the measuring insert is retracted through activation of pressure via the pneumatic actuator.

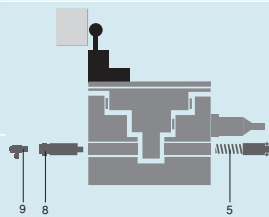

- 5 Spring set for producing measuring force
- 8 Pneumatic actuator (Part No. 03260440)
- 9 Connector (Part No. 024388)

APPLICATION EXAMPLE C

- Activation of the probe insert in the direction of the part to be inspected by pneumatic pressure and the measuring force of the spring set.
- Retraction of the insert by disabling the pneumatic pressure.

ATTENTION !
The force of the spring set (5) must be equal to that of the auxiliary spring element (10).

Result C
During the placing of a new part to be measured, the measuring insert is automatically retracted due to the disabling of the pneumatic pressure, which guarantees about security during the measuring cycle.

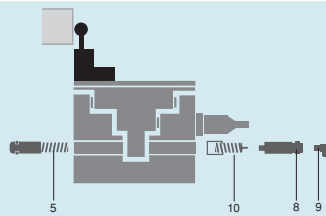

- 5 Spring set for producing measuring force
- 8 Pneumatic actuator (Part No. 03260440)
- 9 Connector (Part No. 024388)
- 10 Auxiliary spring element (Part No. 03260445)

This configuration is typically preferred when there is lack of space for connecting a pneumatic actuator (left side of example B).



- DIN 32876 Part 1
- Hardened steel probe body, nickel-plated
- Linear guidance on ball bearing, 4 M6 mounting threads.. Fixed mechanical stops. Interchangeable inserts. Holder with dovetail clamping. Cable length: 2 m. 5-pin connector DIN 45322.
- Supply frequency: 13 kHz (± 5 %). Max. mechanical frequency*: 25 Hz.
- 0,14 µm/°C
- 20 ± 0,5°C
- IP54 (IEC 60529)
- Mobile weight: 110 g
- Inspection report with a declaration of conformity



Application: measurement with a protected FMS



FMS 102-P



FMS 100-P

Probes with Parallel Guidance, ± 2 mm or ± 2,9 mm, 5,8 mm Measuring Travel – Protected Version

- FMS 100-P, 102 -P, 130-P, 132-P provide dust protection of the 2 side faces.

Modular concept for combining elements, for example, such as springs, pneumatic actuators and stops.

These universal probes are suitable for mutigauging inspection fixtures as well as machines with integrated automated inspection routines.

Versatility of applications:

- Probe can be used in any position for measuring
- Measuring direction can be changed
- Retraction of the measuring insert is adjustable
- Measuring force is adjustable, depending on the accessory used
- Possibility of using off-centre measuring inserts

Unique design:

- Compact assembly noted for its robustness
- Ball bearing guided movement
- Wide variety of measuring inserts, holders and other accessories for measuring applications
- LVDT execution versions compatible with melectronic equipment from other suppliers available on request.

			Measuring range, mm	Nominal measuring force*, N	Bolt retraction	Sealing bellows
03230037	FMS100-P	± 2	2	Retraction by air pressure (optional)	Without bellows	
03230051	FMS130-P	± 2,9	2	Retraction by air pressure (optional)	Without bellows	
03230038	FMS102-P	± 2	2	Retraction through air pressure (optional)	Without bellows	
03230052	FMS132-P	± 2,9	2	Retraction through air pressure (optional)	Without bellows	

	Measuring bolt travel, mm	Max. permissible errors for deviations in linearity, µm (L en mm)	Repeatability, µm	Hysteresis, µm	Setting of lower stop of measuring bolt***, mm	Cable output	Data sheet No.	
FMS100-P	5,8	0,2 + 3 · L ³	0,5	0,5	Fixed stops: lower -2,9 upper +2,9	Parallel	03200283	
FMS130-P	5,8	0,2 + 3 · L ³	0,5	0,5	Fixed stops: lower -2,9 upper +2,9	Parallel	03200344	
FMS102-P	5,8	0,2 + 3 · L ³	0,5	0,5	Fixed stops: lower -2,9 upper +2,9	Angled	03200289	
FMS132-P	5,8	0,2 + 3 · L ³	0,5	0,5	Fixed stops: lower -2,9 upper +2,9	Angled	03200345	

* Electrical zero (N) ± 25 % deviation limit. Valid in vertical mounting position, measuring bolt lowered and in static measuring.

** For an amplitude of 10 % to the last value of the measuring range.

*** Distance from electrical zero.



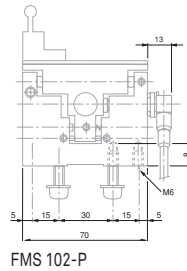
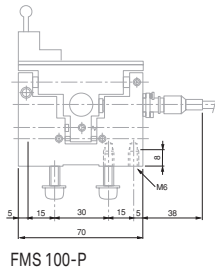

Configuration and Application of TESA FMS Probes

Shown below are the different possibilities for the activation and retraction of the probe insert during measurement cycles.

APPLICATION EXAMPLE A

- Activation of the probe insert in the direction of the part to be inspected using the measuring force produced by the spring set.
- Without retraction of the insert.

Result A
During the placing of a new part to be measured, the measuring insert remains in its contact position thanks to the measuring force produced by the spring set.

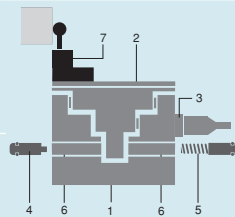

- 1 Static probe body
- 2 Mobile probe body
- 3 Measuring element with fine adjust
- 4 Adjustable stop
- 5 Spring set for producing measuring force
- 6 M6 mounting thread
- 7 Holder

APPLICATION EXAMPLE B

- Activation of the probe insert in the direction of the part to be measured using the measuring force of the spring set.
- Retraction of the insert by pneumatic pressure through a pneumatic connection.

Result B
During the placing of a new part to be measured, the measuring insert is retracted through activation of pressure via the pneumatic actuator.

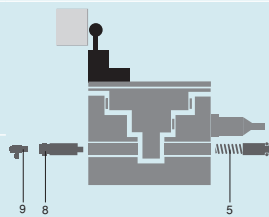

- 5 Spring set for producing measuring force
- 8 Pneumatic actuator (Part No. 03260440)
- 9 Connector (Part No. 024388)

APPLICATION EXAMPLE C

- Activation of the probe insert in the direction of the part to be inspected by pneumatic pressure and the measuring force of the spring set.
- Retraction of the insert by disabling the pneumatic pressure.

ATTENTION !
The force of the spring set (5) must be equal to that of the auxiliary spring element (10).

Result C
During the placing of a new part to be measured, the measuring insert is automatically retracted due to the disabling of the pneumatic pressure, which guarantees about security during the measuring cycle.

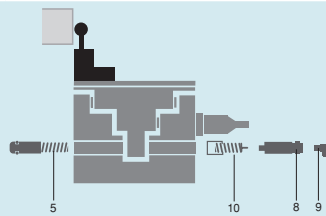

- 5 Spring set for producing measuring force
- 8 Pneumatic actuator (Part No. 03260440)
- 9 Connector (Part No. 024388)
- 10 Auxiliary spring element (Part No. 03260445)

This configuration is typically preferred when there is lack of space for connecting a pneumatic actuator (left side of example B).





 ROHS 2 according to 2011/65/EU
REACH according to EC 1907/2006
WEEE according to 2002/96/EC

 10 x 5 mm

 For a temperature of 20°C and a relative humidity of ≤ 50 %:
Analogue and digital response time: ≤ 100 ms. Holding of digital display: ≥ 100 ms.

 Supply: 4 batteries AA 1,5 V, type LRC 6.
Power consumption: ≈ 7 mW/3,5 V.
Probe supply voltage: 0,7 V.
Supply frequency: 13 ± 0,65 kHz

 For a temperature of 20°C and a relative humidity of ≤ 50 %:
Zero drift and signal amplification: ≤ 0,005 %/°C.
Display frequency limit with respect to input signal: 10 Hz

 IP63 (IEC 60529)

 2004/ 108/EC
EN 61326-1
annex A

 RS232 via TLC connector

 100 x 170 x 38 mm
(W x D x H)

 LCD display size:
70 x 62 mm

 500 g
(including batteries)

 5 decades plus
minus sign

 ± 1 digital step

 Value limit for a temperature of 20°C and a relative humidity of ≤ 50 %:
Analogue display: 1 %
Digital display: 1 %

TESATRONIC TWIN-T10 probe display unit

- Portable display TESATRONIC TWIN-T10 for TESA inductive probe.
- Autonomous instrument used during assembly, on an inspection workstation of a production line, for final inspection or directly on a machine on the shop floor.
- Frequently used with a GT 31 lever probe for geometry measurements: form tolerances (straightness, flatness etc.) or orientation tolerances (parallelism, perpendicularity, etc.).
- Function TOL for measurements with tolerances.
- Memory function for values MAX, MIN or MAX-MIN for dynamic measurements.
- Function for zero-setting of the display, for easy comparative measurements with a reference part.
- Special ZOOM mode for a more detailed visualization of the analogue scale. This mode simplifies the alignment and fine adjustment during assembly.

Other features:

- 4 or 7 measuring ranges from ± 5 µm to ± 5 mm, or switchable automatically depending on the measured value.
- Access to functions by direct keys.
- Millimetre/inch conversion.
- 1 probe signal input.
- Power supply by standard AA batteries.
- RS232 digital output (TLC connector).



TWIN-T10



Designation



Number of probe inputs



Automatic conversion of range



Analogue scale zoom x5



Memory function for values MAX, MIN, MAX-MIN

04430013

TESATRONIC TWIN-T10 1

•

•

•





Run-out measurement with TWIN-T10 and GT 31 lever probe

STANDARD ACCESSORIES:

03210802	GT31 lever probe, $\pm 0,3$ mm, $F = 0,10$ N, standard version
04768000	Hand switch for manually triggering data transfer. Jack plug connector, 1,8 m - TESA SPC PRINTER printer - TESATRONIC TT display units
04768001	Foot switch for triggering data transfer. Jack plug, 1,8 m - TESA SPC PRINTER printer - TESATRONIC (TT) display units
04760181	TESA TLC-USB CABLE for instruments with a TLC connector
04760182	TLC-DIGIMATIC CABLE for instruments with a TLC connector
04760180	TESA TLC-TWIN wireless transceiver. Compatible with any instrument equipped with a TLC connector (TESA Link Connector)
05030012	TWIN-STATION Receiver for wireless TLC-TWIN transceiver
04981001	DATA-DIRECT software and dongle
04981002	STAT-EXPRESS Software and dongle
01460008	Back with central lug
01460009	Back with offset lug

N DIN 32876
Part 1

110 mm scale length

6-decade display
plus minus sign

12,5 x 6,6 mm

126 x 62 mm
LCD display,
with 50 scale
divisions

Value limit for a
temperature of
20°C and a relative
humidity of ≤ 50 %
TT20:
Analogue display:
2%
Digital display 0,3 %
Digital output: 0,3 %
TT60:
Analog display: 2 %
Digital display:
0,3 %
Analogue output:
0,3%
Digital output: 0,3%

± 1 numerical
interval

255 x 235 x 120 mm
(W x D x H)

Resistant plastic
material

For a temperature of
20°C and a relative
humidity of ≤ 50 %:
TT20:
Response time of
analogue, digital and
LED classification
displays: ≤ 80 ms.
Maintenance of
digital display:
80 ms.
TT60:
Response time of
analogue, digital and
LED classification
displays: ≤ 80 ms.
Holding of digital
display: 80 ms.
Response time of
the analogue output
signal in relation to
analogue display: ≤
30 ms.

TESATRONIC TT20 and TT60 Probe Display Units

- Functional reliability.
- User-friendly.
- Essential for inspection in production or metrology laboratory.

TESATRONIC TT20

Combined digital and analogue indication

2 probe inputs for single measurements, sum and difference measurements

- Large LC display for comfortable and error-free reading.
- Pseudo-analogue bargraph indication for a better repeatability and negligible hysteresis.
- Choice between pointer or bargraph indication.
- LCD display for all functions.
- 7 measuring ranges, switchable manually or automatically according to the measured value.
- Direct conversion from metric to inch units.
- Touch button for the indication setting of of each measuring channel.
- Keys for introducing limit values.
- Classification of values (3 classes) and display through colour LEDs with signal outputs.
- Locking of displayed values for step by step measurement routines.
- Automatic recognition of the type of connected TESA probe with adaptation of the measurement signals to the value of output connected (valid only for TESA probes produced from 1997 onwards).
- Opto-coupled RS232 output, bidirectional.
- Power supply through mains adapter.

TESATRONIC TT60

Same features as TESATRONIC TT20, but with following added functions:

- Memory for retaining extreme values "max.", "min.", "max.-min." along with mean value obtained from "max." minus "min."
- Dynamic measurement with acquisition of >100 single values.
- Value classification with output signals through contact relay for 5, 10, 20 or 40 acceptable classes.
- Analogue output for exterior processing of signals.



TT60



TT20

No

=

Measuring range
zoom x5

Memory

04430009 TESATRONIC TT20 Display unit for 1 or 2 inductive probes

-



-

04430010 TESATRONIC TT60 Display unit for 1 or 2 inductive probes

-

•



	 Number of probe inputs	 Automatic switching of range
TESATRONIC TT60 Display unit for 1 or 2 inductive probes		●
TESATRONIC TT20 Display unit for 1 or 2 inductive probes		●

DELIVERED WITH THE FOLLOWING ACCESSORIES:

04761054	Battery charger 100 ÷ 200 VAC 50 ÷ 60 Hz, 6,6 V DC, 750 mAh supplied without power cable
04761055	Mains cable EU for charger 0471054

OPTIONAL ACCESSORIES:

04768000	Hand switch for manually triggering data transfer. Jack plug connector, 1,8 m – TESA SPC PRINTER printer – TESATRONIC TT display units
04768001	Foot switch for triggering data transfer. Jack plug, 1,8 m – TESA SPC PRINTER printer – TESATRONIC (TT) display units
04761062	Opto-USB cable, Duplex, 2m Bidirectional communication
04761049	Opto-RS cable, Duplex, 2m Bidirectional communication

 For a temperature of 20°C and a relative humidity of ≤ 50 %:
TT20:
Response time of analogue, digital and LED classification displays: ≤ 80 ms.
Maintenance of digital display: 80 ms.
TT60:
Response time of analogue, digital and LED classification displays: ≤ 80 ms.
Holding of digital display: 80 ms.
Response time of the analogue output signal in relation to analogue display: ≤ 30 ms.

 RS232 opto-coupled output

 TT60: Voltage Range: ± 2 V to ± 10 V. Output current: ≤ 2 mA. Load adjustment: ≥ 5 kΩ. Background noise (probe at electrical zero) ≤ 1 mV. Reference potential: ground 0 V.

 Supply: 6,5 V DC up to 7,3 V DC. Supply frequency: 13 ± 0,65 kHz. Power consumption: 2 W. Monitored voltage variations. Probe supply voltage: 3 V.

 Protection of frontal face: IP54 (IEC 60529, DIN 40 050)

 IEC/EN 61326-1
USA: CFR47, Part 15, Subpart B, Class B, Digital Device

 1,1 kg



N DIN 32876
Part 1

110 mm scale length

6-decade display
plus minus sign

12,5 x 6,6 mm

126 x 62 mm
LCD display,
with 50 scale
divisions

Limit value for a
temperature of
20°C and a relative
humidity of
≤ 50 %:
Analog display: 2 %
Digital display:
0,15 %
Analog output:
0,3 %
Digital output:
0,15 %

± 1 digital interval

255 x 235 x 120 mm
(W x D x H)

Resistant plastic

TESATRONIC TT 80 and TT 90 Probe Display Units

High resolution display units

Combined analogue/digital display

Two probe inputs for single, sum and difference measurements.

In addition to TESATRONIC TT60 functions, TT 80 has the following additional functions:

- 9 measuring ranges with digital steps of 0,01 µm or 0.000001 in.
- Memorisation of extreme values "max.", "min.", "max. minus min." as well as the mean of the two values "max." and "min."
- Dynamic measurement with acquisition of more than 10 single values per second.
- Classification of measured values with a contact relay providing output signals for 5, 10, 20 or 40 acceptable classes.
- Analogue output for external processing of signals.

In addition to TESATRONIC TT60 functions, TT 90 has the following additional functions:

- 9 measuring ranges with digital step of 0,01 µm or 0.000001 in.
- Memorisation of extreme values "max.", "min.", "max. minus min." plus the mean of both values "max." and "min."
- Dynamic measurement with acquisition of more than 10 single values per second.
- Classification of measured values with output signals through contact relay for 5, 10, 20 or 40 acceptable classes.
- Analogue output for external signal processing.
- Output for bolt retraction control.
- Selection of stabilisation time for measuring cycles.
- RS digital output for values to the micron.



TT 90



TT 80



Application: TT 80 with a SIP (Société genevoise d'instruments de physique) high precision measuring bench

No	=		
		Measuring range zoom x5	Memory
04430011	TESATRONIC TT80 High precision electronic display	-	●
04430012	TESATRONIC TT90 High precision electronic display	-	●

=		
	Number of probes inputs	Automatic conversion of range
TESATRONIC TT80 High precision electronic display	2	●
TESATRONIC TT90 high precision electronic display	2	●



DELIVERED WITH THE FOLLOWING ACCESSORIES:

04761054	Battery charger 100 ÷ 200 VAC / 50 ÷ 60 Hz, 6,6 V DC, 750 mAh, supplied without power cable
04761055	Mains cable EU for charger 0471054

OPTIONAL ACCESSORIES:

04768000	Hand switch for manually triggering data transfer. Jack plug connector, 1,8 m - TESA SPC PRINTER printer - TESATRONIC TT display units
04768001	Foot switch for triggering data transfer. Jack plug, 1,8 m - TESA SPC PRINTER printer - TESATRONIC (TT) display units
04761062	Opto-USB cable, Duplex, 2m Bidirectional communication
04761049	Opto-RS cable, Duplex, 2m Bidirectional communication



For a temperature of 20°C and a relative humidity of ≤ 50 %: Response time analogue, digital and LED displays classification: ≤ 100 ms. Holding of digital display: 100 ms. Response time of the analogue output signal in relation to analogue display: ≤ 30 ms.



For a temperature of 20°C and a relative humidity of ≤ 50 %: Zero drift and signal amplification: ≤ 0,005 %/°C. No drift of stored values. Frequency limit for all displays frequency, analog output and memory in relation to input signal: 10 Hz



RS232 opto-coupled output



Voltage range of ± 2 V to ± 10 V. Output current: ≤ 2 mA. Load adjustment: ≥ 5 kΩ. Background noise (probe to 0 electric) ≤ 1 mV. Reference potential: analog ground 0 V



6,5 Vdc up to 7,3 V DC. Consumption: 2 W. Monitored voltage fluctuation. Supply voltage for probe: 3 V



Protection of frontal face: IP54 (IEC 60529, DIN 40 050)



IEC/EN 61326-1
USA: CFR47, Part 15, Subpart B, Class B, Digital Device



1,1 kg



N DIN 32876
Part 1

Length: 100 mm

Limit value for a temperature of 20°C and a relative humidity of ≤ 50 %: Analog Display: 1,5 % Analog output: 0,3 %

Display: negligible. Classification signals: 5 %

258 x 190 x 158 mm (W x D x H)

Die-cast aluminum case, designed for the workshop

For a temperature of 20°C and a relative humidity of ≤ 50 %: Response time of the analogue display: ≤ 1 ms. Response time of the analogue output signal from the analog display: 20 ms. Response time for classification signals: 10 ms.

For a temperature of 20°C and a relative humidity of ≤ 50 %: Zero drift: ≤ ± 0,005 % /°C. No drift of stored values. Frequency limit for analogue display: 1 Hz. Frequency limit for analogue output: 50 Hz. Frequency limit for classification: 30 Hz

TESATRONIC TTA20 Probe Display Unit

Compact design with analogue indication and value classification of measured values.

Aluminium housing, designed for shop floor applications, user-friendly.

- Easy-to-read analogue display with mirror strip in order to avoid parallax error.
- 6 measuring ranges.
- Metric/Inch conversion.
- Zero setting potentiometer for display.
- 2 probe inputs for single, sum or difference measurements.
- 1 auxiliary signal input, e.g. for all correction values.
- Colour LEDs of green for "Good", yellow for "Rework" and red for "Scrap".
- Potentiometer for setting limit tolerances.
- Polarity reverse switch for classification signals (internal or external dimensions).
- Switch for locking or unlocking a displayed value.
- Analogue output for a display unit or external recording.



TTA20

04430003	TTA20	Number of measuring ranges Min range / Max range max (µm)	Measuring range zoom x5	Memory	Power supply
		6 / min ± 3 max ± 1000	–	–	Network

DELIVERED WITH THE FOLLOWING ACCESSORIES:

03160015	Mains cable CH 2 m
03160016	Mains cable, EU, 2 m
03160017	Mains cable without plug, 2 m for TTA20

OPTIONAL ACCESSORY:

04460004	Connector 15 pins for analogue output and classification signal of TTA20
----------	--

µm	µm	in	in
± 1000	50	± 0.1	0.005
± 300	10	± 0.03	0.001
± 100	5	± 0.01	0.0005
± 30	1	± 0.003	0.0001
± 10	0,5	± 0.001	0.00005
± 3	0,1	± 0.0003	0.00001

Number of probe inputs	Automatic conversion of range
2	–



Accessories for TESATRONIC TT Units



04761055



04761056



04761054



03160017



03160015



03160016

Voltage: ± 1 V. Output current ≤ 3 mA. Adjustment load ≥ 2 k Ω . Residual ripple (at electrical zero): ≤ 1 mV. Reference potential: analogue ground 0 V

Supply voltage 230 or 115 V -10% to +20%, 50-60 Hz. Virtual power: 20 VA. Supply voltage for probe: 1,5 Vrms -10% to +5%. Frequency: 13 kHz $\pm 0,5$ %.

Level of protection: IP40 (IEC 60529)

EN 50081-1
EN 50081-2
EN 50082-1
EN 50082-2

3,4 kg

No	=
04761054	Battery charger 100 ÷ 200 VAC 50 ÷ 60 Hz, 6,6 V DC, 750 mAh supplied without power cable
04761055	Mains cable EU for charger 0471054
04761056	Mains cable US for charger 0471054
03160015	Mains cable CH, 2 m for TTA20
03160016	Mains cable EU, 2 m for TTA20
03160017	Mains cable without plug, 2 m for TTA20
04460004	Connector 15 pins for analogue output and classification signal of TTA20



±2 mm, ±5 mm

0,1 µm

Field error indication (pictogram / text) to a temperature of 20°C and a relative humidity of ≤ 50 %: Digital output: ± (0,05 + 0,15 % of range)

55 x 172 x 155 mm (H x W x D)

Housing in aluminium

For a temperature of 20°C and a relative humidity of ≤ 50 %:
Zero drift: ≤ ± 0,05 %/°C.
Sensitivity drift: ≤ ± 0,05 %/°C.
Acquisition time: 10 ms (between two consecutive measurements) 1 ms (timing window) time data transfer of digital serial output (USB): depends on the operating system of the computer.

USB port (USB Hub) Communication: USB 2.0, 3 external ports (≤ 100 mAh)

Supply voltage of the charger: 115 to 230 Vrms, charger frequency 50 ÷ 60 -10 to +15 % Hz

IP40 (IEC 60529) (DIN 40050)

IEC/EN 61326-1 U.S. 47 CFR part 15, subpart B, Class B digital device

1 kg (BPX) 0,85 kg (TWIN-STATION)

Power supply 100 ÷ 240 V, 50 ÷ 60 Hz (04761054) EU Cable, CH (04761055) U.S. Cable (04761056)

ELECTRONIC INTERFACE UNITS

Electronic interfaces to manage, synchronize inductive probes and allow data transfer to a computer or an automatic inspection machine.

TESA Probe Interface Boxes - BPX Series

Modular system available in 2 versions (BPX and TWIN-STATION) for the conversion of measured signals to digital values and transmission of these values to a computer. These units are key components for multigauging inspection fixtures for centralised process control systems.

Signal inputs – 1 to 4 TESA standard half-bridge probes.

Signal output – digital, RS232 through USB port.

- Direct connection to the computer's USB port.
- Stand Alone operating mode: program routine via the computer, enabling the BPX box to execute a simple measuring function with classification signal relay via connector Sub-D 15P.
- Optimal adaptation for various measuring applications, for example, connection of 16 probes thanks to serial USB connections on 4 BPX boxes.
- Increased functional reliability and high precision.
- Increased immunity to negative environmental effects, whether of electrical origin or provoked by liquid and solid contaminants.
- BPX is compatible and can be used with TWIN-STATION.
- TIS interface software is included in the BPX (part number 05030012) for display of measured values. Possibility of indicating tolerance values, and simple functions +A, -A, +A+B, +A-B, export of values to a .csv file.



BPX Front

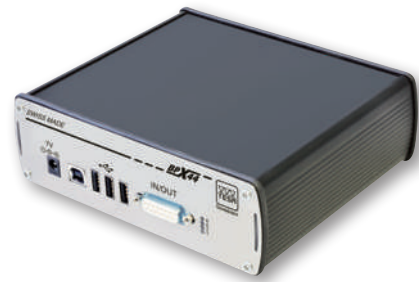

BPX Rear



TIS software included in the BPX supply



	Number of probe inputs	Number of I / O (In / Out) controllers	Connector
05030010	4	1 / 3	Sub-D 15 p/f (for In/Out signals)





GTL 21 W wireless probe with VERIBOR (optional)

TWIN-STATION Receiver for TESA Wireless Probes

Modular system available in 2 executions (TWIN-STATION and BPX) for the conversion of inductive probe signals into digital values for transmission to a computer. These units are important components for measuring fixtures requiring freedom of movement without any constraints and without any cables, a wireless transmission

Signal inputs – 1 to 8 TESA half-bridge wireless probes*

Signal outputs – digital, RS232 through USB port

- Direct connection to the USB port of the computer.
- Perfect fit for your metrology applications through the connection of up to 16 wireless probes by means of serial USB to 2 TWIN-STATION units.
- Great functional reliability and high accuracy.
- TWIN-STATION is compatible and can be used with BPX.
- TIS interface software TIS included in supply of TWIN-STATION (part no. 05030012): display of measured values. Possibility of indicating tolerances, simple functions +A, -A, +A+B, +AB, and export of values to a .Csv file.

Note: The sale of TWIN-STATION is limited to EU countries, Switzerland, USA and Canada.

* The sale of wireless probes is limited to EU countries, Switzerland, USA, Canada and China.



TWIN-STATION, front



TWIN-STATION, rear

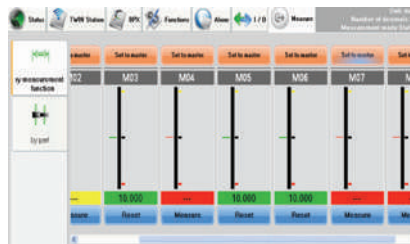

TIS Software, included in the TWIN-STATION supply

- ± 2 mm, ± 5 mm
- 0,1 µm
- For a temperature of 20°C and a relative humidity of ≤ 50 %: Digital output: ± (0,05 + 0,15 % of measuring range)
- 55 x 172 x 155 mm (H x W x D)
- Housing case in aluminium
- For a temperature of 20°C and a relative humidity of ≤ 50 %: Zero drift: ≤ ± 0,05 %/°C. Sensitivity drift: ≤ ± 0,05 %/°C. Acquisition time: 20 ms (between two consecutive measurements) 2 ms (timing window) Time for data transfer from digital serial output (USB): depends on the operating system of the computer
- Power supply via USB cable connection – directly to PC (USB port) – to a USB-connected hub – to a BPX probe interface (05030010)
- IP40 (IEC 60529) (DIN 40050)
- IEC/EN 61326-1 U.S. 47 CFR part 15, subpart B, Class B digital device
- 0,85 kg
- USB cable, 1,80 m



	Number of wireless probes per TWIN-STATION	Power supply	Weight, kg
05030012	1-8	Power supply via: – USB port of PC – USB-connected hub – BPX	0,85

 $\pm 0,5\%$ with reference to the measuring span

 ± 10 to ± 15 V DC, 60 mA

 $\leq \pm 100$ ppm/ $^{\circ}$ C, stability at zero = $\leq \pm 0,2$ μ m/ $^{\circ}$ C

 IP50 (IEC 60529)

TESA Probe Interface Boxes with Analogue Output – Series M4P-2

Signal inputs – TESA standard execution probes (Half-bridge)

Signal outputs – analogue (in \pm V/mm)





- Connection of up to 32 TESA standard half-bridge probes.
- Connection possible to a PC through the A/D transducer.

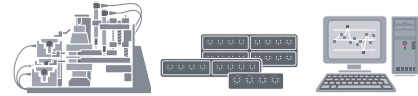

Rack with 3 M4P-2 interfaces



Multi-gauging fixture with 1, 2 or 4 M4P-2 interfaces

No	=					
		Sensitivity (mV / V / mm)	Number of probe inputs	Dimensions (mm)	Analogue outputs	Weight (kg)
S48001721	M4P-2 interface 4 probe inputs with demodulator and analogue output in V/mm	73,75	4, including a demodulator	36 x 100 x 120	± 1 V/mm, $\pm 2,5$ V/mm, ± 5 V/mm, ± 10 V/mm	0,6
S48001722	R2M-1 rack for 2x M4P-2	–	8 (with 2x M4P-2)	55 x 212 x 144	–	0,9
S48001723	R4M-1 rack for 4x M4P-2	–	16 (with 4x M4P-2)	160 x 212 x 144	–	1,2
S48001724	Supply module MA4-2, 230V	–	Voltage: 230 $\pm 10\%$ Vac, 50 Hz	85 x 222 x 146	Output voltage: ± 15 V for 32 probes	1,1
S48001731	Power supply MA4-2, 110 V	–	Voltage: 110 $\pm 10\%$ Vac, 60 Hz	85 x 222 x 146	Output voltage: ± 15 V for 32 probes	1,1

Accessories for M4P-2 probe interface

No	=
S48001725	M4P-2 connecting cable to PC, 2m DB-37 pins m/f



Adaptor Cable: DIN 5p Connector to USB Type A Connector

Allows for quick and easy connection of any TESA standard half bridge probe to a PC USB port.

Signal inputs – TESA standard probes (Half-bridge)
Signal outputs – digital RS 323 through USB port

No	=			
		Measuring range, mm	Deviation span of indication	Zero drift
03260500	Cable adapter DIN 5p for USB. enables connection of TESA probes sensitivity 73,75 mV/V/mm directly to a USB port	± 2 mm	0,3 % ± 0,1 μm	± 0,01 %/°C
03260501	Cable adapter DIN 5p for USB. enables connection of TESA probes sensitivity 29,50 mV/V/mm directly to a USB port	± 5 mm	0,3 % ± 0,1 μm	± 0,01 %/°C





Cable adapter: DIN 5-pin connector to USB connector type A

- DIN 32876 Part 1
- 0.1 μm
- 2 V effectively
13 kHz ± 0,5 %
- At 20°C and relative humidity ≤ 50 %:
error of indication = 0,3 % ± 0,1 μm zero drift ± 0,01 %/°C V.
Standard refresh speed = 80 ms.
Maximum refresh speed = 42 ms.
Distance between the stops and the electrical zero cannot be adjusted.
Length of cable: 1,2 m. Note: the total error should take into account the error of the probe and the error of the adapter.
- USB 2.0 RS232, virtual COM port
- 20 ± 0,5°C
- IP51 (IEC 60529)



 Input impedance
 $970 \pm 50\Omega$ (13 kHz)
 or $2150 \pm 50\Omega$
 (standard 0 μm)
 Phase (13 kHz):
 $71 \pm 2^\circ$. Input
 resistance:
 $100 \pm 5\Omega$. Output
 impedance at
 13 kHz: $1000 \pm 2\Omega$.
 Phase (13 kHz): $0,2^\circ$
 Dummy probe (half-
 bridge), sensitivity
 $73,75 \text{ mV/V/m}$.
 Suitable for
 instruments with
 following features:
 Frequency: 13
 $\pm 0,65 \text{ kHz}$. Voltage:
 $3 \pm 0,015 \text{ Veff}$ (2
 symmetrical voltages
 of 1,5 Veff) Input and
 output impedance:
 $\leq 0,2\Omega$ et 2000Ω ,
 respectively



 Calibration: 40 % to
 60 %. Operating:
 20 % to 80 %.
 Storage: 5 % to
 95 %. Without
 condensation.



 IP40 (IEC 60529)

 Inspection report

 $\varnothing 18 \text{ mm}$, length
 118 mm

 $\approx 45 \text{ g}$

 $20 \pm 0,5^\circ\text{C}$, stabilisa-
 tion time = 8 h

 $\pm 3 \text{ ppm}/^\circ\text{C}$. Ageing:
 $\pm 30 \text{ ppm/a}$

Calibration Standards – Dummy Probes

Calibration standards – also known as "dummy probes" – are resistance dividers. Each calibration standard simulates a given length dimension with high accuracy. Each calibration standard has 2 values (positive and negative). The values indicated below are the nominal values.

These products are calibrated and supplied with an inspection report that shows the values (actual values) measured during calibration and the related measuring uncertainty.

The calibration standards are connected to the instrument in place of regular probes. For the calibration and all required setting operations of the instrument, certain criteria and conditions need to be respected. Consult the user manual or get in touch with our specialists for further information.



Set of 3 calibration standards (S41077249)

No	=	Value of the calibration standard (microns)
S41078077	Dummy probe	± 0
S41078079	Dummy probe	± 3
S41078228	Dummy probe	± 100
S41078230	Dummy probe	± 190
S41078087	Dummy probe	± 300
S41078332	Dummy probe	± 500
S41078751	Dummy probe	± 1000
S41078752	Dummy probe	± 1900
S41077249	Set of 3 dummy probes	$\pm 0 / \pm 100 / \pm 1000$
S41078654	Set of 2 dummy probes	$\pm 190 / \pm 1900$



INSERTS FOR AXIAL PROBES, WITH M2 THREAD

Extensions for Inserts with M2 Thread

No		L, mm
03540505		10
03540506		15

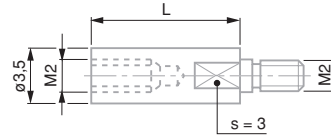

03540505, 03540506

Measuring Insert with Cylindrical Measuring Face, Lock Nut for Radial Alignment, M2 Thread

No			L, mm
03510503	Carbide		6

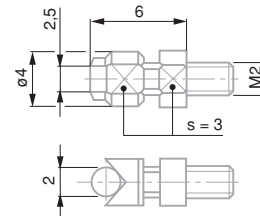

03510503

Hemispherical Measuring Inserts, M2 Thread

No			R, mm	Material	L, mm
03510204			R 1	Carbide	3
03510103			R 5	Carbide	3

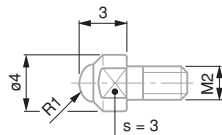

03510204

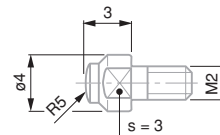

03510103

Spherical Measuring Inserts, R = 5 mm, M2 Thread

No			L, mm
03510202	Carbide		16
03510203	Carbide		26

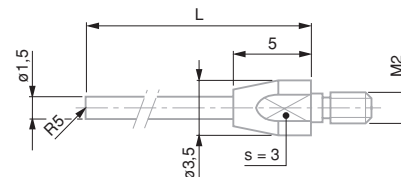

03510202, 03510203



INSERTS FOR AXIAL PROBES, WITH M2,5 THREAD

Extensions for Measuring Inserts, Ø 4 mm, 10 – 40 mm

No	L, mm
03540501	10
03540502	15
03540503	20
03540504	40

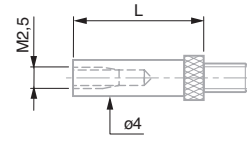

03540501 to 03540504

Standard Spherical Measuring Inserts, R = 1,5 mm, L = 6 mm

No	L, mm	Material	R, mm
03510001	L=6 mm	Steel	6
03510002	L=6 mm	Carbide	6
03560001	L=6 mm	Sapphire	6

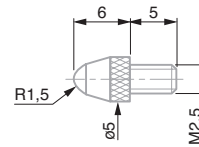

03510001, 03510002, 03560001

Spherical Measuring Insert with 4 Interchangeable Pins, R = 1,5 mm, Length 16-46 mm

No	Material	L, mm
03510201	Steel	16, 26, 36, 46

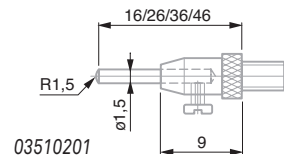

03510201

Spherical Measuring Inserts, R = 5 mm, L = 6 mm

No	Material	L, mm
03510101	Steel	6
03510102	Carbide	6

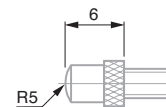

03510101, 03510102

Insert with Cylindrical Measuring Face, Counter Nut for Radial Alignment

No	Material	L, mm
03510502	Carbide	6

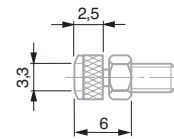

03510502

Spherical Measuring Inserts, R 1 – 8 mm, L > 18mm

No	Material	Ø, mm
03560051	Carbide	1
03560052	Carbide	2
03560053	Carbide	3
03560054	Carbide	4
03560055	Carbide	5
03560056	Carbide	6
03560057	Carbide	7
03560058	Carbide	8

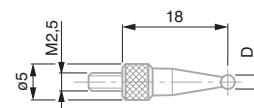

03560051 to 03560058



INSERTS FOR AXIAL PROBES, WITH M2,5 THREAD

Inserts with a Flat Measuring Face $\varnothing 1,5$ mm, Interchangeable Pin, Steel or Carbide

No	\varnothing	Material	L, mm
03560008	1,5	Steel	20
03560009	1,5	Carbide	20

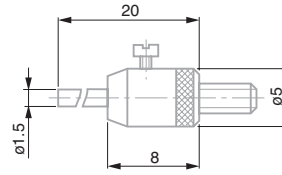

03560008, 03560009

Inserts with Flat Measuring Face, $\varnothing 2$ mm, Steel

No	\varnothing	L, mm	L1, mm
03560026	2	5	2,8
03560027	2	10	7,8
03560028	2	15	12,8
03560029	2	20	17,8

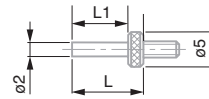

03560026 to 03560029

Insert with Offset (6,5 mm) Measuring Contact Point, Lock Nut for Radial Alignment

No	Material	L (offset), mm
03510401	Steel	6,5

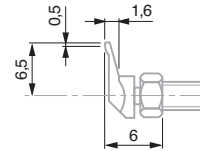

03510401

Inserts with a Flat Measuring Face, $\varnothing 2,5 - 3,4$ mm

No	\varnothing	Material	L, mm
03510801	2,5	Steel	6
03510802	2,5	Carbide	6
03560022	3,4	Steel	8
03560023	3,4	Carbide	8

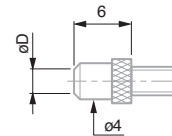

03510801, 03510802, 03560022, 03560023

Inserts with Flat Measuring Face, $\varnothing 5 - 10 - 20$ mm

No	\varnothing	Material	L, mm
03560012	5	Steel	5
03560013	5	Carbide	5
03560014	10	Steel	6
03560015	10	Carbide	6
03560016	20	Steel	3,6

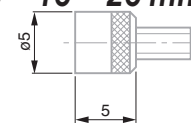

03560012, 03560013

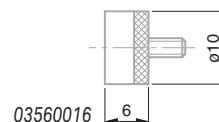

03560016

Insert with Off-centre (6,5 mm) Narrow Face, Lock Nut for Radial Alignment

No	Material	B (measuring face contact), mm
03510602	Carbide	0,5

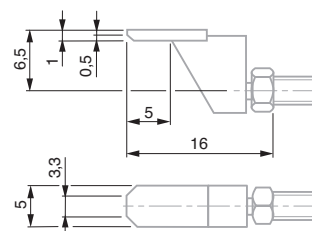

03510602



INSERTS FOR AXIAL PROBES, WITH M2,5 THREAD

Insert with a Flat Measuring Face, \varnothing 2,5 mm, Adjustable Parallelism, Counter-nut for Radial Alignment

03510902	2,5	Carbide	16

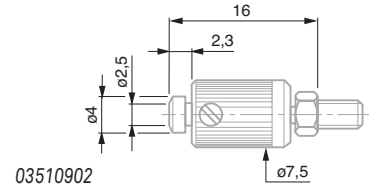

Insert with Offset (12 mm) Contact Point, Lock Nut for Radial Alignment

03560063	Steel	L (offset), mm	
		12	

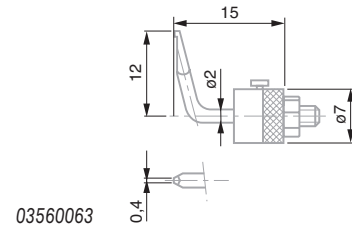

Insert with Narrow Measuring Face, Adjustable Parallelism, Counter-nut for Radial Alignment

03510702	Carbide	B, mm	
		0,5	

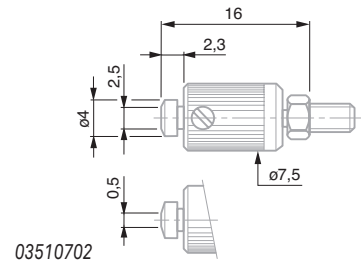

Inserts with Blade-shaped Measuring Face, Lock Nut for Radial Alignment

		L, mm	B (measuring face), mm
03560024	Steel	8	0,3
03560025	Carbide	8	0,3

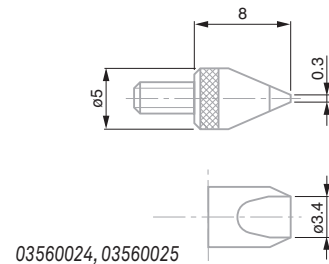

Measuring Inserts with Ball-bearing Rollers, Lock Nut for Radial Alignment

	Roller shape	L, mm	
03560010	Cylindrical	Steel	17,25
03560011	Domed	Steel	17,25

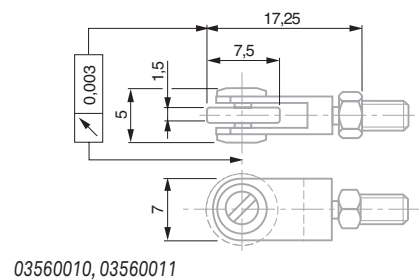

Insert with Needle Contact Point

03560030

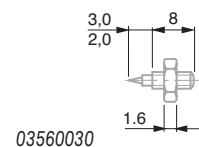

SPRING SETS, BELLOWS, CLAMPING ELEMENTS, MANUAL RETRACTION FOR AXIAL PROBES

Spring Sets for Axial Probes

No	=	Measuring force (N)
03260419	Spring sets for GT22	0,16
03260420	Spring sets for GT22	0,25
03260457	Spring sets for GT21/22	0,63
03260422	Spring sets for GT21/22	1,0
03260423	Spring sets for GT21/22	1,6
03260424	Spring sets for GT21/22	2,5



All values given in the table for the measuring force equal nominal values at electrical zero; max. deviation $\pm 25\%$. Valid for upright assembly position with downward oriented measuring bolt, and used in static measurement.

Bellows for Axial Probes

No	=	
03260468	For 4,3 mm bolt travel GT 21, 22, GTL 21, 211, 22	Nitrile
03260470	For 4,3 mm bolt travel GT 21, 22, GTL 21, 211, 22	Viton
03260489	For pressure probe 4,3 mm bolt travel GTL 212, 222	Viton
03260491	For 10,3 mm bolt travel GT 27, 271, 28, 61, 611, 62	Viton
03260490	For pressure probe 10,3 mm bolt travel GT 272, 282, 612, 622	Viton

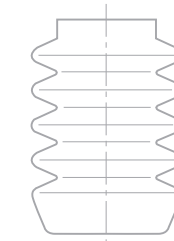

Protection bellow

Nitrile: resistant synthetic sealing for normal use. Viton: high-resistance synthetic sealing. Used in conditions where probes are permanently exposed to coolants and lubricants.

Clamping Elements for Axial Probes

Elements with 3 clamping faces – Prevents any deformation of the measuring bolt guiding system, thus preserving all the metrological properties of the probe.

No	=	∅	A mm
02611013	VKD clamping screw		M4
02611014	VKE clamping sleeve	∅ 8 mm	
01860401	Y61 fixing clamp	∅ 5,6 mm and ∅ 9,5 with dovetail	
02660048	VDE 28 probe holder	∅ 8 mm	

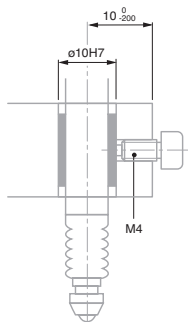

Fixing clamp for axial probe

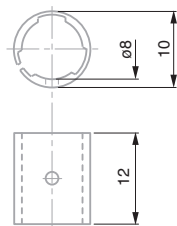

VKE – clamping sleeve

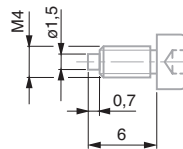

VKD – clamping screw

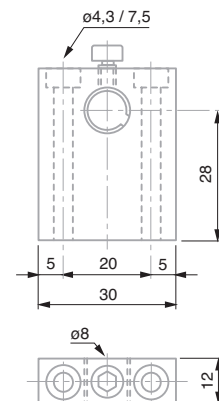

VDE – clamping élément with sleeve and clamping screw



Manual Measuring Bolt Retraction for Axial Probes

No	=	
03540104	TB 11 retraction device components	Consisting of: - 1 Washer TB102 (03540102) - 1 Lifting Lever TB101 (03540101)
03260401	Manual pneumatic retraction device.	Suitable for GT 22, 271, 28, 42, 44, 611, 62 – GTL211, 22 probes Consisting of: - 1 hand-operated vacuum pump - 1 tube of 1m, Ø 4,7 mm (ref. 03540405)
03540405	TB311 flexible tube	

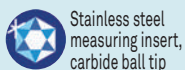
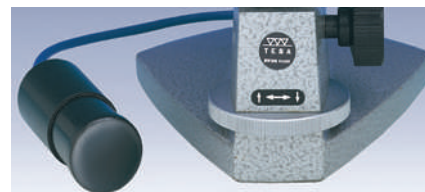

Stainless steel measuring insert, carbide ball tip

ACCESSORIES FOR GT 31 LEVER PROBES

Probe Inserts for GT 31 Lever Probes

No	Ø	Lever – amplification	L, mm	A
03260402	1	1:1	32	One-piece shaft
03260410	2	1:1	32	One-piece shaft
03260403	3	1:1	32	One-piece shaft
03590002	1	1:1	32	Two-piece shaft
03590003	2	1:1	32	Two-piece shaft
03590004	3	1:1	32	Two-piece shaft
03590005	4	1:1	32	Two-piece shaft

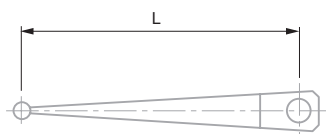

03260410



03260410

Fixing Bracket for TESA GT 31 Lever Probe

No	=	
03240100	Fixing bracket with dovetail clamp or cylindrical bore for GT31 probe	

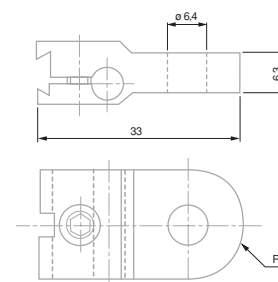

03240100



INSERTS WITH Ø 4 MM MOUNTING SHAFT, FOR FMS PROBES

Probe Inserts with a Flat Rectangular Face, Ø 4 mm Mounting Shaft for FMS Probes

No			L, mm
02660066	Carbide	12	
02660068	Carbide	25	
02660067	Carbide	12	
02660069	Carbide	25	

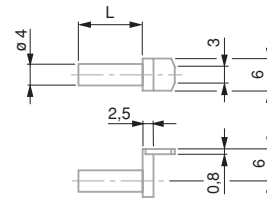

02660067, 02660069

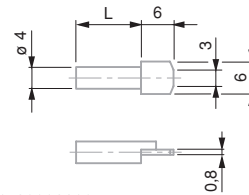

02660066, 02660068

Probe with 2 Cylindrical Measuring Faces with Ø 4 mm Mounting Shaft, for FMS Probes

No			L, mm
02660070	Carbide	20	
02660071	Carbide	40	
02660072	Carbide	60	
02660082	Carbide	40	
02660083	Carbide	60	

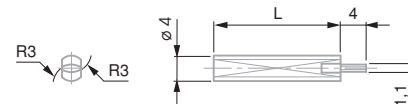

02660070, 02660071, 02660072

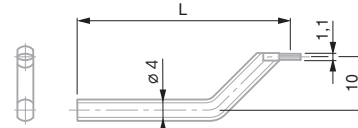

02660082, 02660083

Insert with Ø = 2 mm Diameter Contact Pin, Hemispherical Face with Ø 4 mm Diameter Mounting Shaft for FMS Probes

No			L, mm
02660074	Carbide	40	

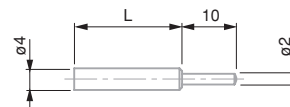

02660074

Probe with Ball Tip Ø 4 mm for FMS Probes

No			L, mm
02660076	3	Carbide	20
02660077	3	Carbide	40
02660078	3	Carbide	60
02660079	5	Carbide	20
02660080	5	Carbide	40
02660081	5	Carbide	60
02660084	5	Carbide	20
02660085	5	Carbide	33

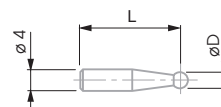

02660076 to 02660081

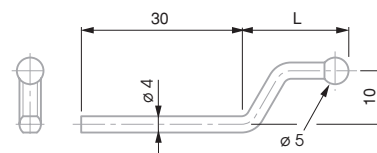

02660084, 02660085



INSERTS WITH Ø 6 MM MOUNTING SHAFT, FOR FMS PROBES

Inserts with Ball Tip, Ø 6 mm Mounting Shaft, for FMS Probes

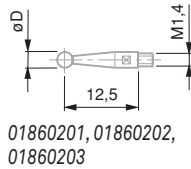

No	Ø	Material	L, mm
00760058	3	Carbide	55
00760059	5	Carbide	56
00760060	10	Carbide	55
01860201	1	Carbide	12,53
01860202	2	Carbide	12,53
01860203	3	Carbide	12,53
01860307	Wrench	-	-

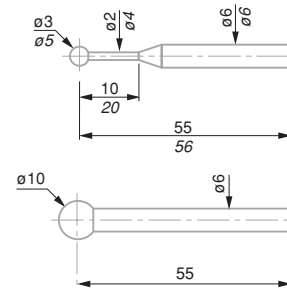

00760058, 00760059, 00760060

Barrel Shaped Inserts for Bores, Ø 6 mm Mounting Shaft, for FMS Probes

No	Ø	Material	Thread
00760066	2,2	Carbide	M3 to M16
00760067	4,5	Carbide	M6 to M48
00760068	9,7	Carbide	M12 to M150

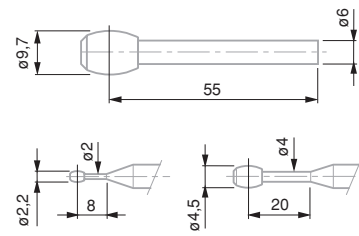

00760066, 00760067, 00760068

Disc Inserts for Grooves, Ø 6 mm Mounting Shaft, for FMS Probe

No	Ø	Material	Disc thickness, mm
00760074	4,5	Carbide	1
00760075	14	Carbide	2
00760076	19	Carbide	3

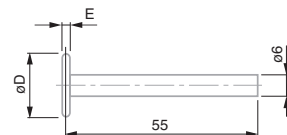

00760075/
00760076

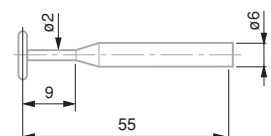

00760074

Special Inserts, Ø 6 mm Mounting Shaft, for FMS Probes

No	Ø	Material	L, mm
00760082	2	Carbide	55

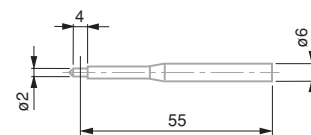

00760082

Universal Probe Holder with Ø 6 mm Mounting Shaft, for FMS Probes

No	Ø	L, mm
00760096	M1,4 and M2,5 threads	55

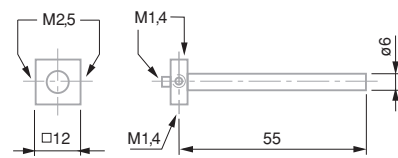

00760096



SPRINGS, PNEUMATIC ACTUATORS, HOLDERS, OFF-SET INSERTS, FOR FMS PROBE

Inserts with Offset Measuring Faces, for FMS Probes

No	=	A	Drawing
02630047	VBM offset insert	1	
02630048	VBN offset insert	2	
02630049	VBO offset insert	3	
02630050	VBP offset insert	4	
02630051	VBQ offset insert	5	

Inserts with offset faces for FMS probes

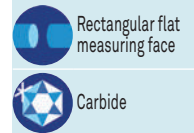
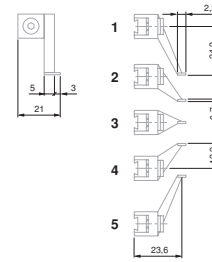

Fixed Holder, for FMS Probe

No	=	∅	A	A	Number	Position
02630042	VBH fixed holder	4	2	Horizontal		
02630043	VBJ fixed holder	4	1	Vertical		
02630045	VBK fixed holder	6	2	Horizontal		
02630046	VBL fixed holder	6	1	Vertical		

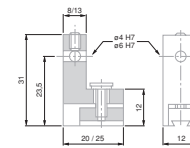

02630042
02630045

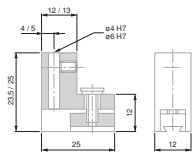

03230043
03230046

Holder with Fine Adjustment for FMS Probe

Helps greatly for setting a FMS probe.

Setting and locking screws remain accessible even when several probes are mounted side by side.

No	mm	∅	A	A	Number	Position
02630053	25	4	2	Horizontal		
02630055	25	4	1	Vertical		
02630052	25	6	2	Horizontal		
02630054	25	6	1	Vertical		

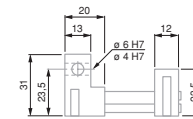

02630052
02630053

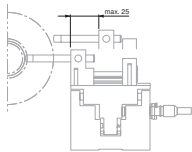

02630053

Auxiliary Springs and Pneumatic Retraction Jack, for FMS Probe

No	=	Hand	N
03260440	Pneumatic jack	11 (for 4 bars)	
03260441	Spring element	0,4	
03260442	Spring element	0,63	
03260443	Spring element	1,0	
03260444	Spring element	1,6	
03260445	Spring element	2,0	
03260446	Spring element	2,5	
03260447	Spring element	4,0	

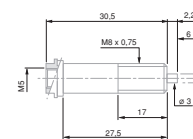

Pneumatic cylinder (jack) for FMS probe

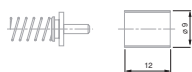

Auxiliary spring element for FMS probe

All values given in the table for the measuring force equal nominal values at electrical zero; max. deviation $\pm 25\%$. Valid for probing movements executed horizontally as well as in static measuring.

Spring Set with Specific Measuring Force, for FMS Probe

No	=	Hand	Measuring force, N
03260448	Spring set red	0,4	
03260449	Spring set yellow	0,63	
03260450	Spring set green	1,0	
03260451	Spring set blue	1,6	
03260452	Spring set brown	2,5	
03260453	Spring set black	4,0	

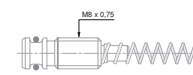

Spring set for measuring force for FMS probe

All values given in the table for the measuring force equal nominal values at electrical zero; max. deviation $\pm 25\%$. Valid for probing movements executed horizontally as well as in static measuring mode.

230 V 50 Hz

Maximum 20 probes type GT 22, GT 42 and GT 44, maximum force 0,63 N. Maximum 10 probes type GT 28 and GT 62, Maximum force 0,63 N.

Electro-pneumatic Pump for Measuring Bolt Retraction

Electro-pneumatic vacuum pump, controlled by external switch (03260433): requires an automatic external command (e.g. instrument display).

No	=	A	
03260432	Electro-pneumatic vacuum pump with activation by connected foot switch	Electro-pneumatic vacuum pump. For the simultaneous retraction of a maximum number of 20 measuring bolts with a force up to 0,63 N	Activation by connected foot switch
03260433	Electro-pneumatic vacuum pump with activation by external control	Electro-pneumatic vacuum pump. For the simultaneous retraction of a maximum number of 20 measuring bolts with a force up to 0,63 N	Activation by external control



Electro-pneumatic vacuum pump

Connectors for Electro-pneumatic Pump for Measuring Bolt Retraction

No	=
03540403	T-connector for tube $\varnothing 4,7 / \varnothing 2$ mm (03540405)
03560000	Straight connector, M4 thread for tube $\varnothing 4,7 / \varnothing 2$ mm (03540405)
03560002	Angled connector, M4 thread for tube $\varnothing 4,7 / \varnothing 2$ mm (03540405)

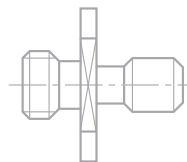

Straight connectors

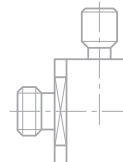

Angled connector

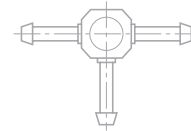

T-connector



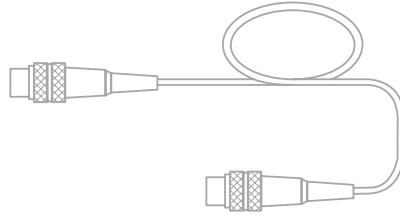

Extension Cable for Probes, Lengths = 1 – 20m

 It is recommended to calibrate equipment (probe + extension) connected together to ensure the highest accuracy.



Cable extensions for TESA probes
DIN 453225, 5 pin connector

	
	Length, m (feet)
03240201	1 m (3 ft)
03240202	2 m (6 ft)
03240203	3 m (9 ft)
03240205	5 m (16 ft)
03240210	10 m (32 ft)
03240215	15 m (49 ft)
03240220	20 m (65 ft)



Accessories

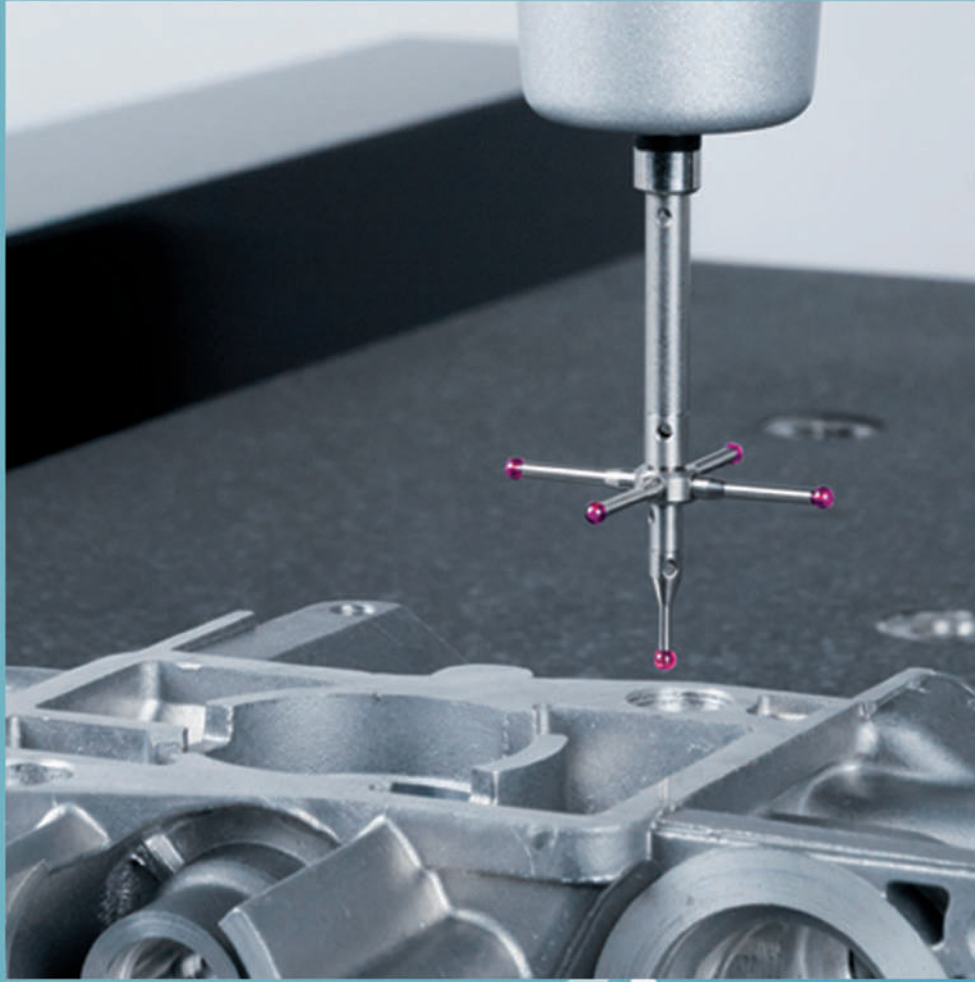

Ruby Ball Stylus, M2 Thread

These styli are used for the majority of probing applications. Highly robust, thanks to their manufacture from industrial rubies, they are however very sensitive, thus avoiding any capture of unwanted points during the movements of a 3D machine.

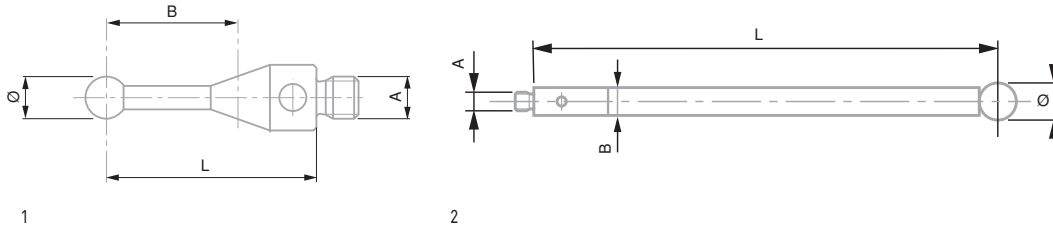

No	Rod	Drawing N°	A mm	Ø mm	L mm	B mm	g
03969201	Inox	1	M2	1	10	4,5	0,3
03969202	Inox	1	M2	2	10	6	0,3
03969203	Inox	1	M2	3	10	7,5	0,4
03969204	Inox	1	M2	4	10	10	0,5
03969205	Inox	1	M2	5	10	10	0,7
03969206	Inox	1	M2	6	10	10	1
03969208	Inox	1	M2	8	11	11	1,5
03969212	Inox	1	M2	2	20	14	0,5
03969213	Inox	1	M2	3	20	17	0,5
03969214	Inox	1	M2	4	20	20,2	0,8
03969220	Tungsten carbide	1	M2	0,5	10	3	0,3
03969221	Tungsten carbide	1	M2	1	20	7	0,6
03969222	Tungsten carbide	1	M2	2	20	15	0,45
03969223	Ceramic	1	M2	3	50	42,5	0,83
03969224	Ceramic	1	M2	4	50	42,5	0,91
03969225	Inox	1	M2	2,5	10	6	0,3
03969226	Tungsten carbide	1	M2	2,5	20	14	0,4
03969259	Tungsten carbide	1	M2	1	27	20,5	0,4
03969260	Carbon	2	M2	4	50	3	1
03969261	Tungsten carbide	1	M2	1,5	30	25	0,58
03969262	Tungsten carbide	1	M2	2	30	25	0,99
03969263	Tungsten carbide	1	M2	3	30	25	1,49
03969267	Tungsten carbide	1	M2	0,7	10	4	0,3
03969268	Tungsten carbide	1	M2	0,3	10	2	0,3
03969269	Tungsten carbide	1	M2	0,5	20	7	0,48
03969271	Tungsten carbide	1	M2	1	20	12,5	0,41
03969272	Tungsten carbide	1	M2	1,5	20	12,5	0,5
03969276	Carbon	2	M2	6	50	50	1,2
03969282	Tungsten carbide	1	M2	2	40	35	1,29
03969283	Tungsten carbide	1	M2	3	40	35	1,97
03969284	Tungsten carbide	1	M2	3	40	35	2,04
03969286	Carbon	2	M2	6	30	30	0,96
03969293	Carbide	1	M2	3	50	42,5	2,44
03969294	Carbide	1	M2	4	50	42,5	2,52
03969295	Tungsten carbide	1	M2	5	50	42,5	3,75



Ruby Ball Stylus, M3 Thread

These styli are used for the majority of probing applications. Highly robust, thanks to their manufacture from industrial rubies, they are however very sensitive, thus avoiding any capture of unwanted points during the movements of a 3D machine.

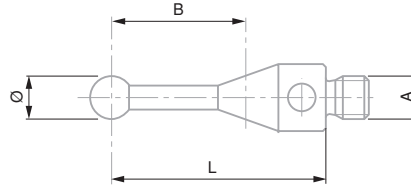

No	Rod	A mm	Ø mm	L mm	B mm	g
03969301	Inox	M3	1	21	4	1,1
03969302	Inox	M3	2	21	8	1,1
03969303	Inox	M3	3	21	12	1,1
03969304	Inox	M3	4	21	17	1,4
03969305	Inox	M3	5	21	21	1,55
03969310	Tungsten carbide	M3	0,5	21	3	1,1
03969312	Tungsten carbide	M3	2	21	15	0,8
03969324	Inox	M3	3	10	–	–
03969326	Inox	M3	6	10	–	–
03969332	Tungsten carbide	M3	2,5	21	12,5	1,3
03969343	Tungsten carbide	M3	3	40	32,5	2,3
03969353	Tungsten carbide	M3	3	50	42,5	2,78



Hemispherical Styli, M2 Thread

Styli usually made of ceramic are generally used to measure deep bores or to avoid taking into account the unwanted irregularities when measuring.

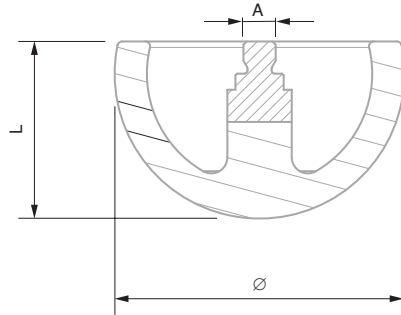

No	=	Rod	A mm	Ø mm	L mm	B mm	g
03969218	Hemispherical stylus, Ø 18 mm	Ceramic	M2	18	11	-	3,3

Hemispherical Styli, M3 Thread

Styli usually made of ceramic are generally used to measure deep bores or to avoid taking into account the unwanted irregularities when measuring.

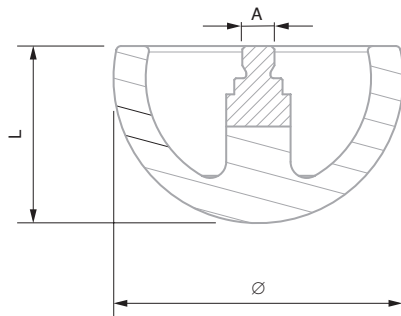

No	=	Rod	A mm	Ø mm	L mm	B mm	g
03969330	Hemispherical stylus, Ø 30 mm	Ceramic	M3	30	17	-	13



Star Styli, M2 Thread

These styli are supplied with several ruby ball tips fixed in different directions. This feature allows a much faster measurement when inspecting internal features without time being wasted by changing the position of a probe.

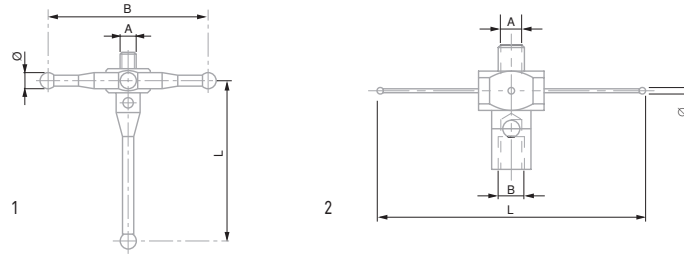

No	=	Rod	Drawing N°	A mm	Ø mm	L mm	B mm	g
03969055	Star stylus, 5 directions	Inox	1	M2	2	20	20	1,5
03969056	Star stylus, 5 directions	Inox	1	M2	2	20	30	1,8
03969081	Star stylus, 5 directions	Inox	1	M2	2	18	20	1,3
03969082	Star stylus, 5 directions	Inox	1	M2	2	18	30	1,7
03969210	Star stylus, 4 directions	Inox	2	M2	0,5	20	M2	0,7

Star Styli, M3 Thread

These styli are supplied with several ruby ball tips fixed in different directions. This feature allows a much faster measurement when inspecting internal features without time being wasted by changing the position of a probe.

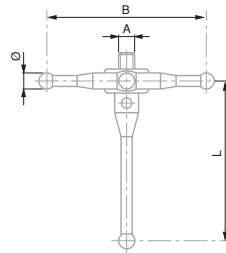

No	=	Rod	A mm	Ø mm	L mm	B mm	g
03969057	Star stylus, 5 directions	Inox	M3	2	20	20	2,2
03969058	Star stylus, 5 directions	Inox	M3	2	20	30	2,5
03969083	Star stylus, 5 directions	Inox	M3	2	18	20	2,2
03969084	Star stylus, 5 directions	Inox	M3	2	18	30	2,5

Cylindrical Styli, M2 Thread

These styli are principally used for the measurement of threads.

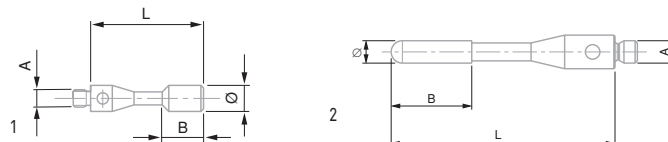

No	Rod	Drawing N°	A mm	Ø mm	L mm	B mm	g
03969251	Inox	1	M2	1,5	11	1,5	0,3
03969252	Inox	1	M2	3	13	3,8	0,6
03969253	Inox	1	M2	3	13	4	0,5
03969292	Tungsten carbide	2	M2	2	20	7,2	0,5



Parallel Styli, M2 Thread

These styli are principally used for the measurement of threads.

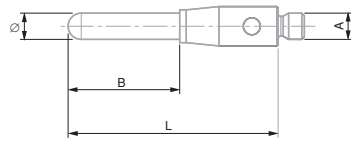

No	Rod	A mm	Ø mm	L mm	B mm	g
03969277	Carbide	M2	0,5	15,3	7,8	0,3
03969278	Carbide	M2	1	35,5	29,8	0,7
03969279	Carbide	M2	2	16	8,5	0,8
03969280	Carbide	M2	2	40	32	2
03969281	Carbide	M2	3	22,5	-	2

Extension M2

The extension allows to enlarge the distance between the probe and the tip of the stylus in order to avoid collision in the depth measurement (e.g. bore).

The use of extensions can greatly reduce the accuracy of the measuring system.

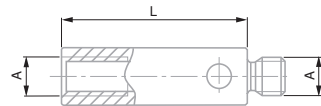

No	Extension	Rod	A mm	Ø mm	L mm	B mm	g
03969230	Extension, L5 mm	Inox	M2	3	5	-	-
03969231	Extension, L10 mm	Inox	M2	-	10	-	0,5
03969232	Extension, L20 mm	Inox	M2	-	20	-	1
03969233	Extension, L30 mm	Inox	M2	-	30	-	1,6
03969234	Extension, L40 mm	Inox	M2	3	40	-	1,8
03969238	Extension, L50 mm	Carbon	M2	3	50	-	1
03969239	Extension, L70 mm	Carbon	M2	3	70	-	1,3
03969240	Extension, L90 mm	Carbon	M2	3	90	-	1,5
03969246	Extension, L40 mm	Ceramic	M2	3	40	-	1,22
03969247	Extension, L50 mm	Ceramic	M2	3	50	-	1,51
03969270	Extension, L40 mm	Carbon	M2	3	40	-	0,9

Extension M3

The extension allows to enlarge the distance between the probe and the tip of the stylus in order to avoid collision in the depth measurement (e.g. bore).

The use of extensions can greatly reduce the accuracy of the measuring system.

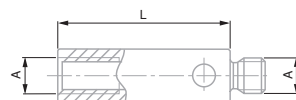

No	Extension	Rod	A mm	Ø mm	L mm	B mm	g
03969044	Extension, L10 mm	Inox	M3	-	10	-	0,8
03969045	Extension, L20 mm	Inox	M3	-	20	-	1,8
03969320	Extension, L35 mm	Inox	M3	-	35	-	2,9

Cross-pieces, M2

Base on which one or several identical or different kind of styli can be mounted. It can be converted into a star stylus or any other desirable configuration.

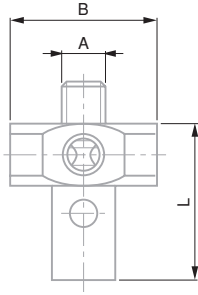

No	=	Rod	A mm	Ø mm	L mm	B mm	g
03969054	5 way cross shaped stylus M2	Inox	M2	-	7,5	7	1,1

Cross-pieces, M3

Base on which one or several identical or different kind of styli can be mounted. It can be converted into a star stylus or any other desirable configuration.

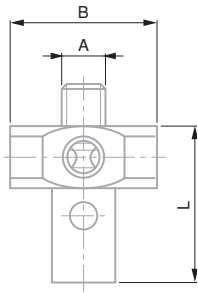

No	=	Rod	A mm	Ø mm	L mm	B mm	g
03969046	5 way cross shaped stylus M3	Inox	M3	-	13	10	3,7

M2 Adaptors

In some cases, accessories that are directly compatible with a probe are not suitable for specific applications. Therefore, it is possible to use an adaptor in order to mount other styli with different threads on it.

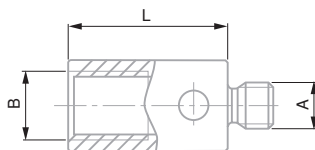

No	=	Rod	A mm	Ø mm	L mm	B mm	g
03969061	Adapter M2-M3	Inox	M2	-	7	M3	0,5



M3 Adaptors

In some cases, accessories that are directly compatible with a probe are not suitable for specific applications. Therefore, it is possible to use an adaptor in order to mount other styli with different threads on it.

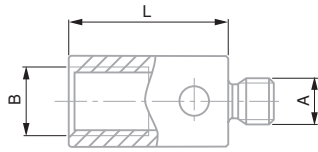

No	=	Rod	A mm	Ø mm	L mm	B mm	g
03969062	ADAPTER M3-M2	Inox	M3	-	5	M2	0,5

Stylus Tightening Keys

Probes and styli are fragile and sensitive items. A special key is provided for fixing a stylus on the probe in order to prevent any damages caused by over-tightening.



No	=	
047866		Stylus key M2 or M3



Stylus Kit

In order to perform several types of measurement, it is often necessary to keep several models of styli. This is why TESA has created standard kits, comprising styli for a variety of dimensions as well as extensions to suit.

No		Kit N° 1, M2 03969086	Kit N° 2, M2 03969087	Kit N° 3, M2 + rigid probe 03969089	Kit N° 1, M3 03969101	Kit N° 2, M3 + rigid probe 03969040
03969085	Case for accessories	1				
047866	Stylus key M2 or M3	2				
049652	Key	2				
050697	Tightening key for carbon fibre styli	2				
03969231	Extension, inox, M2, L = 10 mm	1	1	1		
03969232	Extension, inox, M2, L = 20 mm	1	1	1		
03969233	Extension, inox, M2, L = 30 mm		1			
03969270	Extension, carbone, M2, L = 40 mm	1				
03969044	Extension, inox, M3, L = 10 mm				1	1
03969045	Extension, inox, M3, L = 20 mm				1	1
03969054	5 way cross shaped stylus, inox, M2	1		1		
03969046	5 way cross shaped stylus, inox, M3				1	1
03969082	5 way cross shaped stylus, inox, M2	1				
03969201	Stylus, inox, ruby ball tip, M2, Ø 1 mm, L = 10 mm		1			
03969202	Stylus, inox, ruby ball tip, M2, Ø 2 mm, L = 10 mm	1	1			
03969203	Stylus, inox, ruby ball tip, M2, Ø 3 mm, L = 10 mm		1			
03969204	Stylus, inox, ruby ball tip, M2, Ø 4 mm, L = 10 mm	1	1			
03969212	Stylus, inox, ruby ball tip, M2, Ø 2 mm, L = 20 mm	2		1		
03969213	Stylus, inox, ruby ball tip, M2, Ø 3 mm, L = 20 mm	2		1		
03969221	Stylus, carbide, ruby ball tip, M2, Ø 1 mm, L = 20 mm	1				
03969260	Stylus, carbone ruby ball tip, M2, Ø 4 mm, L = 50 mm	1				
03969302	Stylus, inox, ruby ball tip, M3, Ø 2 mm, L = 21 mm				1	1
03969303	Stylus, inox, ruby ball tip, M3, Ø 3 mm, L = 21 mm				1	1
03969304	Stylus, inox, ruby ball tip, M3, Ø 4 mm, L = 21 mm				1	1
03969214	Stylus, inox, ruby ball tip, Ø 4 mm, L = 20 mm			1		
03969047	Rigid probe, Ø 6.35 mm			1		1



PLASTIFORM

PLASTIFORM moulding pastes allow print molding of complex internal machined parts, which can then be viewed and checked using optical, non-contact measuring equipment. PLASTIFORM mixing pastes» consist of two components, which have to be mixed in equal proportion to ensure proper polymerization. The test object to be reproduced by print molding must be perfectly clean and grease-free before applying Plastiform.

BAD

Fluid consistency best suited for moulding internal and full prints of small and medium sizes. Medium elasticity (10 % of the core) allows prints to be removed in most cases. Reproduces the finest details and can be used for indirect inspection of the surface finish by sight comparison with use of master roughness specimens. Easily cut with the special cutter.

DAV

DAV of fluid consistency best suited for moulding internal and full prints of small and medium sizes. High elasticity (20 % of the core) allows hard prints to be removed such as large re-entrant angle, groove, complex internal shape. Reproduces fine details. Difficult to cut with the special cutter. Print will be preferably checked as a whole.

RGX80

RGX80 is the hardest product of the cartridge range. Pasty consistency best suited for moulding whole internal prints having varying sizes. Weak stretching property and elasticity make it appropriate for easily removable moulding prints.

LKAD

Malleable consistency best suited for moulding internal, external and sectorial prints of small and medium sizes. Applied by hand. Low elasticity (from 1 to 2% of the core) makes it convenient for moulding prints that are removed with ease. Also appropriate for prints held mechanically if desired. Easily cut with the cutter.

PLASTIFORM Set

PLASTIFORM full case Consisting of:

- 1 DS50 injection handle
- 1 Cutter, special with two parallel blades
- 1 PLASTIN (200 g)
- 50 Mixer-Injectors
- 10 Injector end pieces
- 1 DN1 spot remover, 400 ml 21 Rings for mould removal
- 3 PLASTIFORM BAD 50 ml
- 3 PLASTIFORM DAV 50 ml
- 2 PLASTIFORM RGX80 50 ml



Shrinking: less than 1 µm/mm after removal of the mould. Stability: physical properties allow to produce prints which do not deteriorate with time. They will neither be affected by surroundings – hence usable as master standards.

Components with additives free from chlorine, fluorine or sulfur. Being non-toxic and on-polluting can be used with no special restriction

Temperature 20°C

< 10°C: no more polymerization

Properties

	BAD	DAV	RGX80	LKAD
Consistency (max 15)	Fluid (2)	Fluid (4,5)	Pasty	Malleable
Hardness (shore A)	50	20	80	70
Cut using the dual-blade cutter	Easy	Uneasy	Easy	Easy
Check	●	–	●	●
– With contact	●	●	●	●
– Without contact	–	–	●	–
Elasticity	Flexible	Highly flexible	Rigid	Rigid



06869122

PLASTIFORM Full case



Accessories for PLASTIFORM

- BAD, DAV, RGX80, LKAD Cartridges
- Plastin
- Tests kits
- Mixers-injectors
- Cutter, special with two parallel blades
- Injector nozzles DS50
- DN1 spot remover, aerosol can, 400 ml

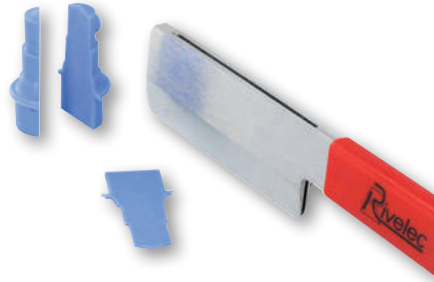

No	=
06869101	PLASTIFORM BAD 8 x 50 ml
06869102	PLASTIFORM DAV 8 X 50 ml
06869106	Mixing injectors, box of 50 pcs
06869107	Mixing injectors, box of 100 pcs
06869108	Mixing injectors, box of 200 pcs
06869109	Fine nozzles box of 20 pcs
06869110	Plastincine, 200 gr
06869111	Special cutter with two parallel blades
06869112	Plastiform pistol DS50
06869113	Degreasing DN1, aerosol 400 ml
06869118	PLASTIFORM RGX8 50 ml
06869119	PLASTIFORM Lite KIT BAD
06869120	PLASTIFORM Lite KIT DAV
06869121	PLASTIFORM LK-AD



TRADEMARKS REGISTERED



TECHNOLOGY



- TESA
- TESA fig.
- ALESOMETRE
- CAPA μ SYSTEM fig.
- COMPAC
- COMPAC fig.
- COMPAC GENEVE fig.
- DIAMASTER
- DIGICO
- DIGIT-CAL
- DIGITMASTER
- DURA-CAL
- ETALON
- ETALON fig.
- ETALON SWITZERLAND fig.
- IMICRO
- INOTEST
- INTERAPID
- INTERAPID fig.
- ISOMASTER
- JUNIOR fig.

- MAGNA μ SYSTEM fig.
- MERCER
- MESOBOR
- MICRO-HITE
- MICROMASTER
- μ HITE fig.
- ROCH FRANCE fig.
- RUGOSURF fig.
- SHOPCAL
- STANDARD GAGE fig.
- TESA DIGITMASTER
- TESA DUOTAST
- TESA EAGLE fig.
- TESA-HITE
- TESA MEMO-HITE
- TESA MICRO-HITE
- TESA SWISSCAL
- TESA SWISSTAST
- TESACAL
- TESADIA
- TESADIGIT

- TESAMASTER
- TESA- μ HITE fig.
- TESANORM fig.
- TESA-SCOPE
- TESASTAR
- TESASTAR fig.
- TESATAST
- TESATRONIC
- TESATRONIC MULTILINE
- TRI-O-BOR
- TRIOMATIC
- UNIMASTER
- UNITEST
- UNITEST fig.
- VERIBOR



NUMERICAL INDEX



001	00250003C-16	00510212 B-18	00530436 B-11	0071684832..... N-29	00760200 N-23
00110101 C-5, 25	00250004C-16	00510222 B-18	00530437 B-11	00730021 N-13	00760201 N-23
00110102 C-5	00250005C-16	00510371 B-23	00530441 B-15	00730022 N-13	00760202 N-23
00110103 C-5	00250006C-16	00510375 B-23	00530442 B-15	00730023 N-13	00760203 N-22
00110104 C-5	00250015C-16	00510383 B-23	00530443 B-15	00730033 N-13	00760204 N-22
00110105 C-5	00250100C-16	00510387 B-23	00530444 B-15	00730034 N-13	00760207 N-23
00110106 C-5	00250101C-16	00510393 B-23	00530445 B-15	00730035 N-13	00760219 .. N-8, 11, 17
00110107 C-5	00250102C-16	00510506 B-13	00530446 B-15	00730043 N-8	00760220 N-19
00110108 C-5	00250103C-16	00510509 B-13	00530447 B-15	00730044 N-8	00760221 N-19
00110109 C-5	00250104C-16	00510511 B-13	00530448 B-16	00730045 N-11	00760222 N-30
00110110 C-5	00250105C-16	00510512 B-13	00530449 B-16	00730046 N-11	00760223 N-29
00110111 C-5	00250106C-16	00510521 B-13	00530450 B-16	00730047 N-5	00760226 N-8, 11
00110112 C-5	00250107C-16	00510522 B-13	00530451 B-16	00730049 N-22	00760227 N-8, 11,
00110113 C-5	00250108C-16	00510531 B-13	00530471 B-19	00730050 N-22 13, 17
00110901 C-11	00250109C-16	00510541 B-13	00530473 B-19	00730054 N-22	00760228 N-25, 26
00111901 C-19	00250115C-16	00510542 B-13	00530474 B-19	00730057 N-11	00760229 N-25, 26
00111902 C-19	00250501C-16	00510551 B-13	00530475 B-19	00730058 N-11	00760230 N-25, 26
00111903 C-19	00250502C-16	00510601 B-13	00530509 B-13	00730059 N-5	00760231 N-5
00111904 C-19	00250503C-16	00510611 B-13	00530521 B-13	00730060 N-17	00760232 N-24
00111905 C-19	00250504C-16	00510621 B-13	00530531 B-13	00730061 N-17	
00140101 C-19	00250505C-16	00510641 B-13	00530701 B-14	00730062 N-17	
00140301 C-18, 19	00269020C-14	00510651 B-13	00530721 B-14	00730063 N-17	
00160101 E-7	00269021C-14	00510661 B-13	00530741 B-14	00730064 N-17	008
00160201 C-3, 21	00269022C-14	00510671 B-13	00530821 B-14	00730065 N-17	00810000 D-4
	00269023C-14	00510681 B-13	00530841 B-14	00760057 N-26	00810001 D-3
	00269024C-14	00510691 B-13	00531004 C-26	00760058 O-67	00810002 D-3
	00269025C-14	00510701 B-14	00531007 C-26	00760059 O-67	00810003 D-3
	00269026C-14	00510711 B-14	00539390 B-5	00760060 N-25, 26,	00810800 D-4
	00269027C-14	00510721 B-14	00539391 B-5	00760060 O-67	00810801 D-3
		00510722 B-14	00539392 B-5	00760061 N-24, 25, 26	00810802 D-3
		00510741 B-14	00539393 B-5	00760066 ..N-26, O-67	00810803 D-3
		00510751 B-14	00560013 B-3, 4,	00760067 ..N-26, O-67	00811500 D-4
		00510801 B-14 5, 6, 7, 8, 9,	00760068 ..N-26, O-67	00811501 D-3
		00510821 B-14 C-25, 26	00760074 ..N-26, O-67	00811502 D-3
		00510841 B-14	00560090 C-26	00760075 N-24, 25, 26,	00811503 D-3
		00510861 B-14	00560095 B-20, 21 O-67	00811504 D-3
		00510871 B-14	00560096 B-20, 21	00760076 ..N-26, O-67	00812300 D-4
		00510911 B-22	00560097 B-20, 21	00760076 ..N-26, O-67	00812301 D-3
		00510915 B-23	00560098 B-20, 21	00760082N-24, 26,	00812302 D-3
		00510921 B-22	00560099 B-20, 21 O-67	00812303 D-3
		00510941 B-22	00560100 B-20, 21	00760086 N-26	00812304 D-3
		00512015 B-23	00560101 B-20, 21	00760087 N-26	00812305 D-3
		00512016 B-23	00560102 B-20, 21	00760093 N-25, 26	00812306 D-3
		00512017 B-23	00560103 B-16, 18	00760094 N-24, 25, 26,	00812600 D-4
		0051610365..... B-8, 9,	00560104 B-16, 18	00760096 O-67	00812601 D-3
	13, 14, 18, 22	00560105 B-16, 18	00760138 N-20	00812602 D-3
		00520001 B-7	00590061 B-20	00760139 N-20	00812603 D-3
		00520002 B-6	00590062 B-20	00760140 N-20	00812604 D-3
		00530020 C-25	00590063 B-20	00760141 N-13, 17	00813101 D-3
		00530021 C-25	00590064 B-20	00760142 N-13, 17	00813102 D-3
		00530094 ... B-4, C-26	00590065 B-20	00760143 N-5, 8,	00813103 D-3
		00530095 B-4	00590066 B-20 11, 13, 17	00813104 D-3
		00530096 B-4	00590067 B-20	00760144 N-13	00813400 D-4
		00530097 B-4		00760148 N-26	00813401 D-3
		00530103 B-9	006	00760150 N-13	00813411 D-3
		00530104 B-9	00610102 J-15	00760151 N-13, 17	00813412 D-3
		00530105 B-9	00630001 J-15	00760152 N-13, 17	00813413 D-3
		00530110 B-9	00630002 J-15	00760153 N-13, 17	0081625081..... D-10
		00530111 B-9	00630003 J-15	00760157 N-5, 8,	0081625082..... D-10
		00530112 B-9	00630010 J-14 11, 13, 17	0081625083..... D-10
		00530120 B-9	00660002 J-15	00760163 N-15	0081625084..... D-10
		00530121 B-9	00660003 J-15	00760164 N-5	0081725001..... D-9
		00530130 B-9	00660004 J-14	00760173 N-25	0081725003..... D-9
		00530131 B-9	00660005 J-14	00760175 N-27	0081725006..... D-9
		00530319 ... B-3, C-26	00660006 J-14	00760177 N-27	0081725008..... D-9
		00530320 B-3	00660007 J-14	00760178 N-27, 28	0081725010..... D-9
		00530321 B-3	00660008 J-14	00760179 N-27, 28	0081725012..... D-9
		00530322 B-3		00760180 N-27, 28	0081725014..... D-9
		00530323 B-3	007	00760181 N-27, 28	0081725016..... D-9
		00530421 B-10	0071684815..... N-29	00760182 N-27, 28	0081725018..... D-9
		00530422 B-10	0071684816..... N-29	00760183 N-27, 28	0081725020..... D-9
		00530423 B-10	0071684817..... N-29	00760184 N-27, 28	0081725022..... D-9
		00530424 B-10	0071684818..... N-29	00760185 N-27, 28	0081725024..... D-9
		00530425 B-10	0071684819..... N-29	00760186 N-22, 28	0081725026..... D-9
		00530426 B-10	0071684820..... N-29	00760187 N-28	0081725028..... D-9
		00530427 B-10	0071684822..... N-29	00760191 N-22	0081725030..... D-9
		00530430 B-12	0071684825..... N-29	00760192 N-22	0081725032..... D-9
		00530431 B-11	0071684826..... N-29	00760194 N-23	0081725034..... D-9
		00530432 B-11	0071684827..... N-29	00760195 N-22	0081725036..... D-9
		00530433 B-11	0071684828..... N-29	00760196 N-23	0081725038..... D-9
		00530434 B-11	0071684829..... N-29	00760197 N-22	0081725063..... D-10
		00530435 B-11		00760198 N-23	0081725066..... D-10
				00760199 N-23	0081725068..... D-10





0081725070.....D-10
 00840001.....D-8
 00840101.....D-17
 00840102.....D-17
 00840103.....D-17
 00840104.....D-17
 00840105.....D-17
 00840106.....D-17
 00840107.....D-17
 00840108.....D-17
 00840109.....D-17
 00840110.....D-17
 00840111.....D-17
 00840112.....D-17
 00840113.....D-17
 00840114.....D-17
 00840115.....D-17
 00840116.....D-17
 00840117.....D-17
 00840118.....D-17
 00840301.....D-8
 00840302.....D-8
 00841100.....D-8
 00841101.....D-8
 00841102.....D-8
 00841800.....D-8
 00841801.....D-8
 00841802.....D-8
 00842600.....D-8
 00842601.....D-8
 00842602.....D-8
 00843101.....D-17
 00843200.....D-17
 00843201.....D-17
 00843230.....D-17
 00843239.....D-17
 00860001.....D-8
 00860007.....D-8
 00860008.....D-8
 00860011.....D-8
 00860012.....D-8
 00860015.....D-8
 00860016.....D-8
 00860017.....D-8
 00862601.....D-8
 00863005.....D-8
 00863016.....D-8
 00863017.....D-8
 00863035.....D-8

009

00910004.....D-16
 00910005.....D-15
 00910006.....D-15
 00910007.....D-15
 00910404.....D-16
 00910405.....D-15
 00910406.....D-15
 00910407.....D-15
 00910704.....D-16
 00910705.....D-15
 00910706.....D-15
 00910707.....D-15
 00911104.....D-16
 00911105.....D-15
 00911106.....D-15
 00911107.....D-15
 00940000.....D-15, 16

011

01110000.....E-5
 01110101.....E-5
 01110102.....E-5
 01110103.....E-5
 01110104.....E-5
 01110105.....E-5
 01110106.....E-5
 01110112.....E-5
 01110118.....E-5
 01110124.....E-5
 01110140.....E-5
 01110203.....E-5
 01110205.....E-5
 01110208.....E-5
 01110300.....E-5

01110401.....E-5
 01110501.....E-5
 01110700.....E-3
 01110801.....E-3
 01110802.....E-3
 01110804.....E-3
 01110808.....E-3
 01110812.....E-3
 01110820.....E-3
 01110901.....E-3
 01111900.....E-7
 01112001.....E-7
 01112002.....E-7
 01112003.....E-7
 01112004.....E-7
 01112301.....E-7
 01112401.....E-5
 01130001.....E-5
 01131901.....E-7
 01131902.....E-7
 01132001.....E-7
 01140801.....E-3
 01141001.....E-3
 01141901.....E-7
 01141902.....E-7
 01160001.....E-5
 01160701.....E-3
 01160901.....E-3
 01161900.....E-7
 01162001.....E-5, 7
 01162301.....E-3
 01162302.....E-3
 01162303.....E-7

014

01410010.....F-17
 01410120.....F-17
 01410210.....F-11
 01410520.....F-18
 01410610.....F-12
 01410611.....F-12
 01410810.....F-19
 01410910.....F-14
 01412010.....F-11
 01412310.....F-12
 01412510.....F-17
 01412511.....F-18
 01412611.....F-18
 01412711.....F-18
 01416013.....F-11
 01416014.....F-11
 01416021.....F-12
 01416034.....F-16
 0141760500.....F-20
 0141760501.....F-20
 0141760503.....F-20
 0141760560.....F-21
 0141760566.....F-24
 0141760624.....F-22
 0141760631.....F-22
 0141760635.....F-22
 0141760636.....F-22
 0141760651.....F-22
 0141760653.....F-22
 0141760661.....F-22
 0141761213.....F-22
 01419047.....F-21
 01419048.....F-23
 01419050.....F-23
 01419051.....F-10
 01419052.....F-10
 01460008.....F-29, O-48
 01460009.....F-29, O-48
 01460014.....F-29
 01460015.....F-29
 01462004.....F-29
 01462005.....F-29

015

01510000.....H-7
 01510100.....H-7
 01510200.....H-7
 01510300.....H-7

016

01610200.....I-11
 01610201.....H-8, I-11
 01610401.....L-7
 01630003.....G-5
 01639000.....I-8
 01639003.....I-7
 01639004.....I-7
 01639006.....I-7
 01639007.....G-5, I-10
 01639008.....I-8
 01639009.....H-8, I-11
 01639016.....I-10
 01639017.....I-5
 01639018.....I-5
 01639019.....I-5
 01639020.....I-4
 01639022.....I-3
 01639023.....I-3
 01639024.....I-6
 01639025.....I-3
 01639029.....I-9
 01639033.....I-9
 01639035.....I-9
 01639046.....I-12
 01639047.....I-12
 01639053.....I-4
 01640000.....I-11
 01640000.....H-8
 01640100.....I-8
 01640501.....I-10
 01660011.....L-7
 01690021.....L-7

018

01810005.....G-4, 5
 01810006.....G-4
 01810007.....G-4
 01810008.....G-4
 01810009.....G-4
 01810010.....G-4, 5
 01810011.....G-5
 01810012.....G-5
 01810013.....G-5
 01810204.....G-4
 01810205.....G-4
 01810304.....G-4
 01811000.....G-4
 01811001.....G-4
 01830001.....G-2
 01830002.....G-2
 01840104.....G-5, 6, 14
 01840105.....G-5, 6, 14
 01840106.....G-13
 01840107.....G-13
 01840108.....G-13
 01840109.....G-13
 01840202.....G-6, 14
 01840404.....G-6, 14
 01840405.....G-6, 14
 01840406.....G-6, 14
 01840407.....G-6, 14
 01840501.....G-6, 14
 01850106.....G-13
 01850107.....G-13
 01860008.....G-6, 14
 01860201.....G-5, O-67
 01860202.....G-5, O-67
 01860203.....G-5, O-67
 01860211.....G-5
 01860212.....G-5
 01860213.....G-5
 01860301.....G-5
 01860302.....G-5
 01860303.....G-5
 01860304.....G-5
 01860305.....G-5
 01860307.....G-5, 8, O-67
 01860401.....G-6, 14, O-64
 01866003.....G-13
 01866004.....G-13
 01866006.....G-13
 01866014.....G-13

01866015.....G-13
 01866016.....G-13
 01866021.....G-13
 01866022.....G-13
 01866023.....G-13
 01866026.....G-13
 01866027.....G-13

019

01930000.....F-7
 01930001.....F-7
 01930130.....F-8
 01930131.....F-8
 01930132.....F-8
 01930133.....F-8
 01930134.....F-9
 01930135.....F-9
 01930230.....F-3
 01930231.....F-3
 01930240.....F-4
 01930241.....F-4
 01930250.....F-4
 01930255.....F-4
 01930256.....F-5
 01930257.....F-5
 01930258.....F-6
 01960005.....F-7, 9, 29, N-20
 01960007.....F-7
 01961000.....B-3, 4, 5, 10, 11, 12, 16, 19, 20, C-3, 8, D-5, 11, F-6, 9, G-2, J-14
 01961012.....F-9
 01962002.....F-6

021

02119021.....C-3
 02130001.....H-2
 02130002.....H-2
 02130003.....H-2
 02140001.....C-20
 02140002.....C-20
 02140003.....C-20
 02140004.....C-20
 02140005.....C-20
 02140006.....C-20
 02140007.....C-20
 02140008.....C-20
 02140009.....C-20
 02140010.....C-20
 02140011.....C-20
 02140012.....C-20
 02140013.....C-20
 02140014.....C-20
 02140015.....C-20
 02140016.....C-20
 02140017.....C-20
 02140018.....C-20
 02140019.....C-20
 02140020.....C-20
 02140103.....C-20
 02140108.....C-20
 02160020.....H-3
 02160021.....H-3
 02160023.....H-3
 02160024.....H-3
 02160025.....H-3
 02160026.....H-3
 02160028.....H-4
 02160027.....H-2
 02160029.....H-4
 02160030.....H-5
 02160035.....H-5
 02160038.....H-2
 02160043.....H-3
 02160044.....H-3

025

02510000.....C-21
 02510001.....C-21

02510002.....C-21
 02510003.....C-21
 02510004.....C-21
 02510100.....C-21
 02510101.....C-21
 02510102.....C-21
 02510103.....C-21
 02510200.....C-21
 02510201.....C-21
 02510202.....C-21
 02510203.....C-21
 02510300.....C-21
 02510301.....C-21
 02510302.....C-21
 02510303.....C-21
 02530050.....K-7
 02530075.....K-7

026

02611013.....O-64
 02611014.....O-64
 02630042.....O-68
 02630043.....O-68
 02630045.....O-68
 02630046.....O-68
 02630047.....O-68
 02630048.....O-68
 02630049.....O-68
 02630050.....O-68
 02630051.....O-68
 02630052.....O-68
 02630053.....O-68
 02630054.....O-68
 02630055.....O-68
 02660048.....O-64
 02660066.....O-66
 02660067.....O-66
 02660068.....O-66
 02660069.....O-66
 02660070.....O-66
 02660071.....O-66
 02660072.....O-66
 02660074.....O-66
 02660076.....O-66
 02660077.....O-66
 02660078.....O-66
 02660079.....O-66
 02660080.....O-66
 02660081.....O-66
 02660082.....O-66
 02660083.....O-66
 02660084.....O-66
 02660085.....O-66

031

03130060.....J-6
 03130063.....J-6
 03160007.....J-6, 11
 03160008.....J-6, 11
 03160009.....J-6, 11
 03160015.....O-53, 54
 03160016.....O-53, 54
 03160017.....O-53, 54
 03160048.....J-6, 11

032

03210801.....O-42
 03210802.....O-12, 42, 48
 03210803.....O-42
 03210904.....O-6, 16
 03210905.....O-16
 03210906.....O-16
 03210907.....O-16
 03210908.....O-16
 03210921.....O-17
 03210922.....O-17
 03210923.....O-17
 03210924.....O-6, 17
 03210925.....O-17
 03210926.....O-17
 03210927.....O-17
 03210928.....O-17
 03230001.....O-12, 37
 03230002.....O-12, 37

03230017.....O-12, 38
 03230019.....O-14, 43
 03230021.....O-6, 22
 03230026.....O-6, 19
 03230027.....O-6, 19
 03230028.....O-14, 43
 03230035.....O-12, 38
 03230036.....O-6, 21
 03230037.....O-14, 45
 03230038.....O-14, 45
 03230041.....O-6, 20
 03230042.....O-6, 20
 03230049.....O-14, 43
 03230050.....O-14, 43
 03230051.....O-14, 45
 03230052.....O-14, 45
 03230053.....O-8, 24
 03230054.....O-8, 23
 03230055.....O-8, 25
 03230056.....O-6, 18
 03230057.....O-6, 18
 03230058.....O-10, 33
 03230059.....O-10, 33
 03230060.....O-8, 23
 03230061.....O-8, 24
 03230062.....O-8, 25
 03230063.....O-8, 23
 03230067.....O-8, 23
 03230068.....O-8, 24
 03230069.....O-8, 24
 03230070.....O-8, 25
 03230071.....O-8, 25
 03230072.....O-6, 18
 03230073.....O-6, 19
 03230081.....O-10, 36
 03230085.....O-10, 35
 03230086.....O-10, 34
 03230087.....O-10, 34
 03230200.....O-10, 30
 03230201.....O-10, 30
 03230202.....O-10, 31
 03230204.....O-10, 32
 03230205.....O-10, 32
 03230500.....O-10, 26
 03230501.....O-10, 28
 03230502.....O-10, 27
 03230503.....O-10, 29
 03238013.....F-9
 03240100.....O-65
 03240201.....O-70
 03240202.....O-70
 03240203.....O-70
 03240205.....O-70
 03240210.....O-70
 03240215.....O-70
 03240220.....O-70
 03260401.....L-7, O-65
 03260402.....O-65
 03260403.....O-65
 03260410.....O-65
 03260419.....O-64
 03260420.....O-64
 03260422.....O-64
 03260423.....O-64
 03260424.....O-64
 03260432.....L-7, O-69
 03260433.....L-7, O-69
 03260440.....O-68
 03260441.....O-68
 03260442.....O-68
 03260443.....O-68
 03260444.....O-68
 03260445.....O-68
 03260446.....O-68
 03260447.....O-68
 03260448.....O-68
 03260449.....O-68
 03260450.....O-68
 03260451.....O-68
 03260452.....O-68
 03260453.....O-68
 03260457.....O-64
 03260468.....O-64
 03260470.....O-64
 03260479.....O-64
 03260489.....O-64
 03260490.....O-64
 03260491.....O-64



03260500 O-58
 03260501 O-58

033
 03330004 H-14
 03330006 H-15
 03360300 H-14

035
 03510001 .. F-25, O-61
 03510002 .. F-25, N-22,
 O-61
 03510101 .. F-25, O-61
 03510102 .. F-25, O-61
 03510103 .. F-28, O-60
 03510201 .. F-25, O-61
 03510202 .. F-28, O-60
 03510203 .. F-28, O-60
 03510204 .. F-28, O-60
 03510401 .. F-26, O-62
 03510502 .. F-26, O-61
 03510503 .. F-28, O-60
 03510602 .. F-26, O-60
 03510702 .. F-27, O-63
 03510801 .. F-27, O-62
 03510802 .. F-27, O-62
 03510902 .. F-27, O-63
 03540104 .. F-29, O-65
 03540403 O-69
 03540405 O-65
 03540501 .. F-28, O-61
 03540502 .. F-28, O-61
 03540503 .. F-28, O-61
 03540504 .. F-28, O-61
 03540505 .. F-28, O-60
 03540506 .. F-28, O-60
 03560000 O-69
 03560001 .. F-25, O-61
 03560002 O-69
 03560004 F-29
 03560005 F-29
 03560006 F-29
 03560007 F-25
 03560008 .. F-27, O-62
 03560009 .. F-27, O-62
 03560010 .. F-26, O-63
 03560011 .. F-26, O-63
 03560012 .. F-27, O-62
 03560013 .. F-27, O-62
 03560014 .. F-27, O-62
 03560015 .. F-27, O-62
 03560016 .. F-27 O-62
 03560017 F-25
 03560018 F-25
 03560019 F-25
 03560020 F-25
 03560021 F-25
 03560022 .. F-27, O-62
 03560023 .. F-27, O-62
 03560024 .. F-26, O-63
 03560025 .. F-26, O-63
 03560026 .. F-27, O-62
 03560027 .. F-27, O-62
 03560028 .. F-27, O-62
 03560029 .. F-27, O-62
 03560030 .. F-26, O-63
 03560031 F-26
 03560032 F-26
 03560033 F-26
 03560034 F-26
 03560035 F-25
 03560036 F-25
 03560037 F-25
 03560038 F-25
 03560039 F-25
 03560040 F-25
 03560042 F-27
 03560043 F-27
 03560044 F-27
 03560045 F-27
 03560046 F-27
 03560047 F-27
 03560048 F-27
 03560049 F-27
 03560050 F-27

03560051 .. F-25, O-61
 03560052 .. F-25, O-61
 03560053 .. F-25, O-61
 03560054 .. F-25, O-61
 03560055 .. F-25, O-61
 03560056 .. F-25, O-61
 03560057 .. F-25, O-61
 03560058 .. F-25, O-61
 03560063 .. F-26, O-63
 03560065 F-27
 03560092 F-27
 03590002 O-65
 03590003 O-65
 03590004 O-65
 03590005 O-65

038
 038407 N-22

039
 03969007 A-10
 03969040 P-9
 03969044 P-6, 9
 03969045 P-6, 9
 03969046 P-7, 9
 03969047 P-9
 03969054 P-7, 9
 03969055 P-5
 03969056 P-5
 03969057 P-5
 03969058 P-5
 03969061 P-7
 03969062 P-8
 03969081 P-5
 03969082 P-5, 9
 03969083 P-5
 03969084 P-5
 03969085 P-9
 03969086 P-9
 03969087 P-9
 03969089 P-9
 03969101 P-9
 03969201 P-2, 9
 03969202 P-2, 9
 03969203 P-2, 9
 03969204 P-2, 9
 03969205 P-2
 03969206 P-2
 03969208 P-2
 03969210 P-5
 03969212 P-2, 9
 03969213 P-2, 9
 03969214 P-2, 9
 03969218 P-4
 03969220 P-2
 03969221 P-2, 9
 03969222 P-2
 03969223 P-2
 03969224 P-2
 03969225 P-2
 03969226 P-2
 03969230 P-6
 03969231 P-6, 9
 03969232 P-6, 9
 03969233 P-6, 9
 03969234 P-6
 03969238 P-6
 03969239 P-6
 03969240 P-6
 03969246 P-6
 03969247 P-6
 03969251 P-5
 03969252 P-5
 03969253 P-5
 03969259 P-2
 03969260 P-2, 9
 03969261 P-2
 03969262 P-2
 03969263 P-2
 03969267 P-2
 03969268 P-2
 03969269 P-2
 03969270 P-6, P-9
 03969271 P-2
 03969272 P-2

03969276 P-2
 03969277 P-6
 03969278 P-6
 03969279 P-6
 03969280 P-6
 03969281 P-6
 03969282 P-2
 03969283 P-2
 03969284 P-2
 03969286 P-2
 03969292 P-5
 03969293 P-2
 03969294 P-2
 03969295 P-2
 03969301 P-3
 03969302 P-3, 9
 03969303 P-3, 9
 03969304 P-3, 9
 03969305 P-3
 03969310 P-3
 03969312 P-3
 03969320 P-6
 03969324 P-3
 03969326 P-3
 03969330 P-4
 03969332 P-3
 03969343 P-3
 03969353 P-3

044
 04430003 O-53
 04430009 O-49
 04430010 O-49
 04430011 O-51
 04430012 L-7, O-51
 04430013 O-47
 04460004 O-53, 54

047
 04760070 N-8, 11
 04760087 L-7
 04760099 A-12,
 M-6, 14
 04760180 A-7,
 B-3, 4, 10,
 11, 12, 16, 19,
 O-48
 04760181 A-10,
 B-3, 4, 10,
 11, 12, 16, 19,
 O-48
 04760182 A-10,
 B-3, 4, 10,
 11, 12, 16, 19,
 O-48
 04761017 A-11
 04761023 A-10, N-13
 04761024 A-10
 04761027 A-9
 04761037 A-11, F-7
 04761038 A-10
 04761046 A-9
 04761047 N-20
 04761049 A-9, L-7,
 O-50, 52
 04761052 A-9,
 N-5, 8, 11,
 19, 22
 04761054 A-6, 11,
 F-6,
 N-5, 8, 11,
 13, 17, 22,
 O-50, 52, 54, 11
 04761055 A-6, 11,
 F-6,
 N-5, 8, 11,
 13, 17, 22,
 O-54
 04761057 A-11, F-7
 04761059 J-6, 11

04761060 A-10, F-9,
 G-2
 04761062 A-9, C-3,
 J-14,
 O-50, 52
 04761063 A-9,
 N-5, 8, 11,
 19, 22
 04761070 L-7
 04761071 A-5
 04765008 .. N-11, 15, 19
 04765013 A-6
 04768000 A-11, F-7,
 L-7,
 O-48, 50, 52
 04768001 A-11,
 O-48, 50, 52
 04768002 J-3, 4,
 5, 11
 04768035 A-6
 047866 P-8, 9

049
 049652 P-9
 04981001 A-3, 7,
 O-48
 04981002 A-4, 7,
 O-48

050
 05030010 O-55
 05030012 A-7, 8,
 O-26, 27, 28,
 29, 48, 56
 050697 P-9

053
 05330003 J-5
 05330004 J-5
 05330005 J-5
 05330202 J-4
 05330203 J-3
 05331000 J-9
 05331002 J-9
 05331050 J-8
 05331054 J-8
 05331058 J-8
 05331061 J-8
 05331063 J-8
 05331201 J-8
 05331202 J-8
 05331204 J-8
 05331206 J-8
 05331210 J-8
 05331450 J-9
 05331500 J-7
 05331502 J-7
 05331550 J-7
 05331551 J-7
 05331750 J-10
 05360004 J-4, 11
 05360006 J-3, 11
 05360014 J-3, 11

056
 056109 A-12, M-20
 056133 M-21
 056223 M-21
 056224 M-22
 056631 M-9, 22
 056633 M-22
 056639 M-22
 056641 M-22
 056645 M-12

057
 05710012 H-10
 05710013 H-10
 05710014 H-10
 05710015 H-10
 05710016 H-10
 05710017 H-10

05710018 H-10
 05710090 H-9
 05710091 H-9
 05710092 H-9
 05710093 H-9
 05740001 H-11
 05760013 H-11
 05760027 H-11
 05760029 H-11
 057655 M-6, 22
 057941 M-6

058
 058213 A-12, M-20
 059215 N-24

059
 05919002 L-11
 05930000 L-7
 05930003 L-7
 05930011 L-9
 05930013 L-7
 05930015 L-7
 05939001 L-11
 05960011 L-9
 05960012 L-9
 05960018 L-9
 05960025 L-8
 05960026 L-9
 05960030 L-7
 05960038 L-9
 05960039 L-7
 05969000 L-12
 05969001 L-12
 05969002 L-13
 05969004 L-13
 05969007 L-12
 05969008 L-12
 05969009 L-13
 05969010 L-13
 05969011 L-13
 05969012 L-13
 05969015 L-11
 05969020 L-11, 12
 05969021 L-12
 05969022 L-12
 05969023 L-12
 05969024 L-11, 12
 05969024 L-11
 05969029 L-11
 05969030 L-11
 05969032 L-12
 05969033 L-12
 05969034 L-12

060
 06030010 C-3, 26
 06030020 C-3, 26
 06030021 C-3
 06030022 C-3
 06030023 C-3
 06030029 C-3
 06030030 C-3
 06030031 C-3
 06030032 C-3
 06030033 C-3
 06030034 C-8
 06030038 C-23
 06030039 C-23
 06030040 C-23
 06030041 C-13
 06030042 C-13
 06030043 C-13
 06030044 C-13
 06030045 C-14
 06030047 C-18
 06030048 C-18
 06030049 C-18
 06030050 C-18
 06030051 C-18
 06030062 C-15
 06030063 C-15
 06030064 C-15
 06030065 C-15

06030069 C-22
 06030070 C-22
 06030071 C-3
 06030072 C-3
 06030073 C-3
 06030074 C-3
 06030075 C-3
 06030076 C-3
 06030077 C-3
 06030078 C-3
 06030079 C-10
 06030081 C-10
 06030087 C-11
 06030088 C-11
 06030089 C-11
 06030090 C-11
 06030091 C-11
 06030092 C-11
 06030093 C-11
 06030094 C-11
 06030095 C-11
 06030096 C-11
 06030097 C-11
 06030099 C-14
 06060021 C-22

061
 06130101 D-5
 06130102 D-5
 06130103 D-5
 06130104 D-5
 06130105 D-5
 06130106 D-5
 06130107 D-5
 06130108 D-5
 06130109 D-5
 06130110 D-5
 06130111 D-5
 06130112 D-5
 06130113 D-5
 06130114 D-5
 06130115 D-5
 06130116 D-5
 06130117 D-5
 06130118 D-5
 06130119 D-5
 06130120 D-5
 06130121 D-5
 06130122 D-5
 06130123 D-5
 06130124 D-5
 06130125 D-5
 06130126 D-5
 06130127 D-5
 06130128 D-5
 06130220 D-6
 06130221 D-6
 06130222 D-6
 06130223 D-6
 06130224 D-6
 06130225 D-6
 06130230 D-7
 06130231 D-7
 06130232 D-7
 06130233 D-7
 06130234 D-7
 06130235 D-7
 06160002 D-8
 06160003 D-8
 06160005 D-8
 06160006 D-8
 06160007 D-8

062
 06230023 D-11
 06230024 D-11
 06230025 D-11
 06230026 D-11
 06230027 D-11
 06230028 D-11
 06230029 D-11
 06230030 D-11
 06230031 D-11
 06230032 D-11
 06230033 D-11





06230034 D-11
 06230035 D-11
 06230036 D-11
 06230037 D-11
 06230038 D-11
 06230039 D-11
 06230051 D-11
 06230052 D-11
 06230100 D-12
 06230110 D-12
 06230111 D-12
 06230112 D-12

064
 06430000 A-6

065
 0651511011 K-6
 0651511012 K-6
 0651511014 K-5
 0651511021 K-5
 0651511027 K-5
 0651512011 K-6
 0651512012 K-6
 0651512014 K-5
 0651512021 K-5
 0651512028 K-5
 0651515011 K-6
 0651515012 K-6
 0651515014 K-5
 0651515021 K-5
 0651515027 K-5
 0651516011 K-6
 0651516012 K-6
 0651516014 K-5
 0651516021 K-5
 0651516027 K-5
 0651570269 K-7
 0652500422 K-7
 0652500424 K-7

067
 06719000 J-16
 06739001 J-13
 06769002 K-8
 06769004 I-13
 06769005 J-16
 06769006 I-12
 06769007 I-13
 06769010 I-14

068
 06869101 P-11
 06869102 P-11
 06869106 P-11
 06869107 P-11
 06869108 P-11
 06869109 P-11
 06869110 P-11
 06869111 P-11
 06869112 P-11
 06869113 P-11
 06869118 P-11
 06869119 P-11
 06869120 P-11
 06869121 P-11
 06869122 P-10

069
 06930011 M-8
 06930012 M-11
 06930013 M-5
 06960033 M-6, 9,
 12, 20
 06960034 M-6, 9, 14
 06960035 M-6, 9, 23
 06960036 M-6, 9, 17
 06960037 M-6, 9, 18
 06960038 M-6, 9, 18
 06960039 M-6, 9, 18
 06960040 M-6, 9, 18
 06960041 M-6, 9,

..... 12, 24
 06960042 M-22
 06960043 M-21
 06960044 M-21
 06960045 M-6, 9, 22
 06960046 M-22
 06960047 M-9
 06960048 M-12, 15
 06960049 M-12, 17
 06960050 M-12, 19
 06960051 M-12, 19
 06960052 M-12, 19
 06960053 M-12, 19
 06960054 M-12, 19
 06960055 M-12, 23
 06960056 M-6, 9,
 12, 18, 19
 06960057 M-6, 9, 18
 06960058 M-12, 19
 06960059 M-22
 06960061 M-12, 19
 06960062 A-12,
 M-9, 12,
 13, 14, 16
 06960064 M-6, 9,
 12, 24
 06960065 M-6, 9,
 12, 24
 06960066 M-6, 9,
 12, 24
 06960067 M-12, 19
 06960081 M-6, 9, 18
 06960100 M-12, 13
 06960101 M-13, 16
 06960102 M-13, 16
 06960103 M-13, 16, 24

072
 072103522 C-9
 072103576 E-8
 072103585 E-8
 072103586 E-8
 072105462 E-8
 072108669 C-6
 072108691 C-6
 072108722 C-6
 072109030 E-8
 072109055 E-8
 072109066 E-8
 072109089 E-8
 072109101 E-8
 072109107 E-8
 072109108 E-8
 072109117 E-8
 072109128 E-8
 072110123 C-3, 21
 072110816 C-7
 072110853 C-7
 072110978 C-6
 072112020 C-20
 072112021 C-20
 072115943 C-24
 072116406 C-4
 072116407 C-4
 072116408 C-4
 072116409 C-4

074
 074105993 G-9
 074105994 G-9
 074105995 G-9
 074106026 G-8, 9
 074106331 G-8, 9
 074106358 G-9
 074106360 G-9
 074107893 G-9
 074107895 G-9
 074107897 G-9
 074108603 G-9
 074108942 G-8, 9
 074110481 G-9
 074110482 G-9
 074110491 G-9
 074110492 G-9
 074110493 G-9

074110507 G-9
 074111366 G-8
 074111367 G-8
 074111368 G-8
 074111369 G-8
 074111375 G-8
 074111376 G-8
 074111474 G-8
 074111502 G-8
 074111503 G-8
 074111504 G-8
 074111505 G-8
 074115604 H-13
 074115605 H-13
 074115606 H-13
 074115607 H-13
 074115608 H-13
 074115664 H-13

075
 075115821 B-7

076
 076115566 J-15
 076115567 J-15

077
 07739001 N-31
 07739002 N-31
 07739003 N-31
 07769001 N-31
 07769003 N-31
 07769005 N-31
 07769006 N-31

078
 078110592 D-14
 078110594 D-14
 078110596 D-14
 078110598 D-14
 078110733 D-13
 078110735 D-13
 078110737 D-13
 078110739 D-13
 078112356 D-13
 078112357 D-13
 078112358 D-13
 078112359 D-13
 078112360 D-13
 078112361 D-13
 078112362 D-13
 078112363 D-13
 078112364 D-13
 078112365 D-13
 078112366 D-13
 078112367 D-13
 078112368 D-13
 078112369 D-13
 078112370 D-13
 078112371 D-13
 078112372 D-13
 078112373 D-13

079
 079105667 H-12
 079105668 H-12
 079105669 H-12
 079105694 H-12
 079105704 H-12
 079105756 H-12
 079108502 H-12
 079110110 H-12
 079110111 H-12
 079111401 H-12
 079112051 H-12
 079112052 H-12
 079112126 H-12

081
 081112053 M-25
 081112054 M-25

081112055 M-25
 081112056 M-25
 081112057 M-25
 081112058 M-25
 081112059 M-25
 081112060 M-25
 081112061 M-25
 081112062 M-25
 081112063 M-25
 081112344 M-25
 081112345 M-25
 081112346 M-25

095
 0951750002 J-12
 0951750003 J-12
 0951750005 J-12
 0951750006 J-12
 0951750007 J-12
 0951750181 I-14
 0951750182 I-14
 0951750184 I-14
 0951750187 I-14
 0951750222 E-8
 0951750223 E-8
 0951750224 E-8
 0951750225 E-8
 0951751533 J-13
 0951751534 J-13
 0951751535 J-13
 0951751605 J-12
 0951751607 J-12
 0951753001 I-15
 0951753002 I-15
 0951753003 I-15
 0951753013 I-15
 0951753014 I-15
 0951753015 I-15
 0951753045 I-15
 0951753046 I-15
 0951754511 I-16

96
 96160013 O-12, 40
 96410012 O-12, 39
 96430029 O-12, 41
 96441041 O-12, 41

300
 353 F-11
 353E F-11
 355 F-15
 355E F-15
 365S F-15
 367 F-17
 367E F-17

500
 512K F-12
 532 F-12
 532E F-12
 533S F-12
 555 F-16
 555E F-16
 556 F-18
 556E F-18
 556G F-19
 565S F-16
 567 F-18

700
 712 F-13
 722 F-13
 732 F-13

S
 S18001695 G-4
 S41077249 O-59
 S41078077 O-59
 S41078079 O-59
 S41078087 O-59

 Order number	 Magnetic measuring system "MAGNA μ SYSTEM", patented	 Material hardness	 Maximum relative humidity
 Standard	 Mm/in conversion	 Measuring force	 Degree of protection
 Measuring range Measuring span	 Maximum permissible errors Limit deviations	 Shockproof design	 Electromagnetic compatibility
 Range of indication Max. plunger travel	 Deviation span of indication	 Maximum displacement speed	 Mass
 Displacement range	 Repeatability limit	 Product designation	 Included in scope of supply
 Application range	 Hysteresis	 Execution	 Packaging
 Analogue indication Longitudinal scale	 Maximum permissible straightness error	 Special features	 Identification number
 Upper vernier	 Maximum permissible flatness error	 Notes	 Declaration of conformity
 Lower vernier	 Maximum permissible roundness error	 Function mode	 Inspection report
 Circular scale	 Maximum permissible parallelism error	 Floating zero	 Inspection report with a declaration of conformity
 Dial	 Maximum permissible cylindricity error	 Fixed zero	 SCS calibration certificate
 mm or in/revolution	 Maximum permissible perpendicularity error	 Blocking of display	 Certificate of another type
 Scale interval	 Maximum permissible runout error	 Digital interface	 Reverse numbering or +left
 Resolution magnification	 Quality grade	 Analogue interface	 Dial locking knob
 Numerical scale	 Uncertainty of measurement accuracy	 Power supply	 Connectivity
 Numerical interval	 Frame	 Autonomy	 TWIN
 Height of signs/digits	 Measuring face or faces	 Coefficient of linear expansion	 ABS
 Analogue/numerical indication	 Dimensions	 Working temperature range	 Height of signs/digits 11 mm
 Material measure Measuring system	 Diameter	 Operating temperature range	
 Capacitive measuring system "CAPA μ SYSTEM", patented	 Thread pitch	 Storage temperature range	



HEXAGON
MANUFACTURING INTELLIGENCE

About Hexagon Manufacturing Intelligence

Hexagon Manufacturing Intelligence helps industrial manufacturers develop the disruptive technologies of today and the life-changing products of tomorrow. As a leading metrology and manufacturing solution specialist, our expertise in sensing, thinking and acting – the collection, analysis and active use of measurement data – gives our customers the confidence to increase production speed and accelerate productivity while enhancing product quality.

Through a network of local service centres, production facilities and commercial operations across five continents, we are shaping smart change in manufacturing to build a world where quality drives productivity. For more information, visit HexagonMI.com.

Hexagon Manufacturing Intelligence is part of Hexagon (Nasdaq Stockholm: HEXA B; hexagon.com), a leading global provider of information technologies that drive quality and productivity improvements across geospatial and industrial enterprise applications.



TESA
TECHNOLOGY

About TESA

Established in 1941 and headquartered in Renens, Switzerland, TESA SA manufactures and markets precision measuring instruments that stand for quality, reliability and longevity.

For 75 years, TESA has distinguished itself in the market through its excellent products, its unique expertise in micromechanics and precision machining as well as its proven experience in dimensional metrology.

The TESA brand is the global market leader in the field of height gauges and a pioneer thanks to its wide range of instruments, including callipers, micrometers, dial gauges, lever-type dial test indicators and inductive probes. TESA is a true benchmark for the inspection of incoming goods, as well as for production workshops and quality assurance laboratories.

Through its worldwide distribution network the company focuses on the mechanical engineering, micromechanical, automotive, aerospace, watchmaking and medical industries.

In 2001, TESA became part of Hexagon, a leading global provider of information technologies.

www.tesatechnology.com